

F 4

Crown Copyright Reserved

PW—F4

Post Office Engineering Department

TECHNICAL PAMPHLETS FOR WORKMEN

Subject :

Private Branch Exchanges, Common Battery System

ENGINEER-IN-CHIEF'S OFFICE,
1919

(Reprinted April, 1928, including Correction Slips to date)

(..	March, 1931,
(..	Jan., 1932,

LONDON

PUBLISHED BY HIS MAJESTY'S STATIONERY OFFICE

To be purchased directly from H.M. STATIONERY OFFICE at the following addresses:
York House, Kingsway, London, W.C.2; 120 George Street, Edinburgh 2;
26 York Street, Manchester 1; 1 St. Andrew's Crescent, Cardiff;
80 Chichester Street, Belfast;
or through any bookseller

1938

Price 6d. net

LIST OF Technical Pamphlets for Workmen

GROUP A.

1. Magnetism and Electricity.
2. Primary Batteries.
3. Technical Terms.
4. Test Boards.
5. Protective Fittings.
6. Measuring and Testing Instruments.
7. Sensitivity of Apparatus.
8. Terms and Definitions used in Telegraphy and Telephony.

GROUP B.

1. Elementary Principles of Telegraphy and Systems up to Morse Duplex.
2. Telegraph Concentrators.
3. Wheatstone. Morse Keyboard Perforators.
4. Quadruplex. Telegraph Repeaters, Sx., Dx., and Quad.
5. Hughes Type-printing Telegraph.
6. Baudot Multiplex.
7. Western Electric Multiplex. Murray Multiplex. Other Systems.
8. Fire Alarm Systems.

GROUP C.

1. Wireless Transmission and Reception.
2. Interference with Reception of Broadcasting.

GROUP D.

1. Elementary Principles of Telephony.
2. Telephone Transmission "Loading." Telephone Repeaters and Thermionic Valves.
3. Principles of Telephone Exchange Signalling.
4. Magneto Exchanges—Non-Multiple Type.
5. Magneto Exchanges—Multiple Type.
6. C.B.S. No. 1 Exchanges—Non-Multiple Type.
7. C.B.S. Exchanges—Multiple Type.
8. C.B. Exchanges—No. 9 Type.
9. C.B. Exchanges—No. 10 Type.
10. C.B. Exchanges—No. 12 Type.
11. C.B. Exchanges—22 Volts.
12. C.B. Exchanges—40 Volts.
13. Trunk Telephone Exchanges.
14. Telephone Exchange Maintenance.
15. Telephone Testing Equipment.
16. Routine Testing for Manual Telephone Exchanges.
17. Internal Cabling and Wiring.
18. Distribution Cases, M.D.F. and I.D.F.
19. Cord Repairs.
20. Superposed Circuits, Transformers, etc.
21. Call Offices.

[Continued on page iii of Cover.]

CORRECTION SLIP TABLE.

The month and year of issue is printed at the end of each amendment in the Correction Slips, and the number of the slip in which any particular amendment is issued can, therefore, be traced from the date. In the case of short corrections made in manuscript, the date of issue of the slip should be noted against the correction.

The Summary portions of the Correction Slips should be completed and affixed below in numerical order.

CORRECTION SLIP TABLE (contd.)

The month and year of issue is printed at the end of each amendment in the Correction Slips, and the number of the slip in which any particular amendment is issued can, therefore, be traced from the date. In the case of short corrections made in manuscript, the date of issue of the slip should be noted against the correction.

The Summary portions of the Correction Slips should be completed and affixed below in numerical order.

FOR OFFICIAL USE

**PRIVATE BRANCH EXCHANGES,
C.B. SYSTEM**

(F4)

*The following pamphlets in this series are of
kindred interest :—*

- D. 1. Elementary Principles of Telephony.
- D. 2. Telephone Transmission, "Loading," Telephone Repeaters and Thermionic Valves.
- D. 3. Principles of Telephone Exchange Signalling.
- D. 8. C.B. Exchanges—No. 9 Type.
- D. 9. C.B. Exchanges—No. 10 Type.
- D.10. C.B. Exchanges—No. 12 Type.
- D.11. C.B. Exchanges—22 Volts.
- D.12. C.B. Exchanges—40 Volts.
- D.14. Telephone Exchange Maintenance.
- D.16. Routine Testing for Telephone Exchanges.
- D.17. Internal Cabling and Wiring.
- D.19. Cord Repairs.
- F. 1. Subscribers' Apparatus, C.B.
- F. 8. Wiring of Subscribers' Premises.

PRIVATE BRANCH EXCHANGES, C.B. SYSTEM

TABLE OF CONTENTS.

	PAGE
GENERAL PRINCIPLES	3
TYPES OF SWITCHBOARDS	6
CORDLESS. NEGATIVE CLEARING	7
CORDLESS. POSITIVE CLEARING	12
DOUBLE CORD BOARDS	15
INSTALLATION	24
TESTING OUT	25
MAINTENANCE	25

PRIVATE BRANCH EXCHANGES, C.B. SYSTEM

A Private Branch Exchange (P.B.X.) is a subscriber's installation consisting of a switchboard with one or more Exchange lines and more than one extension terminated thereon. Inter-communication between the extensions is always provided. The methods of operating are described in dealing with each type of switchboard. Generally, the objects to be attained by the use of a P.B.X. are :—

(1) The speedy handling of incoming calls, the caller being connected by the P.B.X. operator to the particular department with which he wishes to communicate.

(2) That communication may be obtained with the main exchange or with another department in the same building by any member of the staff without loss of time in travelling from one room or floor to another.

The number of extensions provided is at the discretion of the firm renting the P.B.X. The number of exchange lines depends upon the amount of traffic to be handled.

GENERAL PRINCIPLES.

Before passing on to an examination of the details of standardised P.B.X. equipment, it will be helpful first to clear the ground by referring briefly to some of the general principles on which these designs have been based.

Incoming Calls.—Only one telephone number is quoted in the telephone directory against a P.B.X. subscriber's name, irrespective of the number of exchange lines rented. At the main exchange, the first exchange line of the group serving the P.B.X. is connected to the jack bearing this number on the subscriber's multiple, and the remaining lines in the group are connected to successive adjacent jacks numbered consecutively so that they form a complete group of lines. The fact that these jacks serve the same P.B.X. is indicated to the operators by means of a continuous distinctively coloured line painted immediately underneath the series. On receiving a call for a P.B.X. number, the operator tests along the group of jacks and connects to the first disengaged line.

When the connection at the exchange has been made as described, a ringing current is sent to line, which operates an indicator on the branch exchange switchboard. The P.B.X. operator connects her telephone to the proper exchange line, speaks to the caller, and obtains from him either the name of the person, or the department, or the number of the extension

with which he wishes to communicate. Having obtained this information, she makes the desired connection and rings the extension.

Originating Calls.—When the subscriber wishes to make a call from one of the extensions, it is only necessary to lift the receiver off the hook in order to signal the P.B.X. operator. The latter answers the call, and makes the connection either to another extension or to an exchange line, as may be required.

Night Facilities.—Exchange service may be required by certain of the extensions after the usual business hours. Arrangements are made in these cases whereby the extensions are connected each to an exchange line and are afforded an exchange service quite independent of the P.B.X. The method of working is then the same as for an ordinary subscriber's line with a single station.

Speaking Keys or their equivalent are necessary on all sizes of boards to enable the operator to exercise full supervision by listening in at will on any connection.

Supervisory Signals.—Double supervision is desirable, *i.e.*, one signal for each party connected, and whenever possible these signals should be positive in action, that is, the intimation should be conveyed to the operator by the appearance of a previously invisible signal, not by the disappearance of a previously visible one.

On the smaller switchboards, as constant attention may not be practicable, the supervisory signals should be connected to an audible alarm. This will assist in obtaining prompt disconnection of finished calls.

Control of Exchange Lines.—So far as an *A* operator at the main exchange is concerned, a call for a P.B.X. is effective as soon as the attention of the P.B.X. operator has been gained, and any subsequent extension of the call at the P.B.X. should produce no effect on the main exchange supervisory signals. When therefore the P.B.X. operator answers an incoming call, the corresponding supervisory lamp at the main exchange should be darkened and should not light up again until the call is finished.

On boards with capacity for more than twelve lines in all, it is now customary to vest the control of the exchange lines entirely in the P.B.X. operator, that is to say, the exchange line is permanently "held" from the time the P.B.X. operator plugs in to answer a call until she withdraws the plug when the call is finished. This method is permissible on the larger installations because the amount of traffic is generally such as to warrant the undivided attention of a special operator, and consequently the clearing of connections can be effected promptly. It has the great advantage of permitting extension

stations to signal to the P.B.X. operator during the progress of a call without affecting the supervisory signals at the main exchange, thereby permitting an extension station to get an established call transferred to another extension station when required, a facility which is regarded as an essential on the larger installations.

On the smaller boards with capacities for twelve lines or less where, as a rule, the undivided attention of a special operator is difficult to justify and the clearing of connections is frequently the reverse of prompt, it is necessary to modify these arrangements in order to secure the prompt release of exchange lines and junction circuits on the conclusion of a conversation.

On such installations the exchange line is "held" from the time the P.B.X. operator answers the call until the extension station hangs up at its conclusion, when a simultaneous signal is given on the *A* cord circuit at the main exchange and at the P.B.X. The main exchange acts on this signal and frees the exchange line and junction circuits concerned without having to wait until the P.B.X. operator has responded to her signal.

It should be noted that on small P.B.X.'s working on this system the extension station is unable to signal to the P.B.X. operator during the progress of a call, without at the same time causing false signals to appear before the main exchange operator. This is a distinct disadvantage when it is desired to transfer established calls from one extension to another, but it is a lesser evil than the unnecessary holding up of valuable junction lines which would result were the other scheme applied in these cases.

Ring Back Keys.—When an extension station desires a connection over the ordinary exchange system, the correct procedure is for the extension to give the name of the exchange and the subscriber's number to the P.B.X. operator, who will pass the particulars forward to the main exchange and see the call through. If the user at the extension station is too busy to remain at the telephone until the connection is established, he hangs up the receiver and waits for the P.B.X. operator to ring him. This necessitates provision for ringing back to the calling subscriber and, consequently, *ring back keys* are provided on P.B.X. connecting circuits.

Current Supply for Extension Talk.—Power for operating P.B.X.'s is generally drawn from the main exchange battery, over special feeders known as power leads. Considerations of economy and the nature of the external cable plant prevent these conductors being provided on a basis liberal enough to ensure the maintenance at the P.B.X., under all conditions, of

a voltage comparable with that of the main exchange supply. Actually, sufficient conductors are provided to ensure that the voltage drop in the power lead during the period of maximum demand shall not reduce the voltage available at the P.B.X. below a figure which, with standard C.B. apparatus at the extension stations, will afford a grade of transmission sufficiently good for local conversations between the extension stations. For the non-multiple type of board this figure is 12 volts.

A higher standard of transmission, however, is required for exchange talk and trunk work. To this end the circuits at the P.B.X. are so arranged that an extension station, connected through to an exchange line, draws current for operating its transmitter direct from the exchange line, and is quite independent of the fluctuating supply drawn from the power lead.

Ringling Current to enable the P.B.X. operator to call the extensions may be obtained from a hand-generator fixed on the switchboard, or, if the amount of traffic warrants, may be obtained from the main exchange over a special circuit known as a Ringling Lead. In any case, a hand-generator is provided as a stand-by.

Having given a general outline of the facilities to be provided, and the engineering requirements to be met, the different types of branch exchange switchboards will now be considered in detail.

TYPES OF SWITCHBOARDS.

There are **three types of boards**, classed according to the method of fixing, *viz.* :—

**Wall,
Table, and
Floor.**

These are further classed according to their equipment as "**Cordless**" and "**Double Cord**" Boards. The standard Cordless boards are all of the Table pattern. The Double Cord boards are either Wall or Floor pattern.

The capacity and equipment of a switchboard are usually indicated briefly by means of a fraction, thus $\frac{1+4}{5}$ would mean a switchboard equipped for 1 exchange and 4 extension lines, and having a total capacity for 5 lines. Similarly $\frac{3+10}{25}$ indicates equipment for 3 exchange and 10 extension lines, and a total capacity for 25 lines.

Details of connections, with an explanation of the working, of each type of switchboard, will now be dealt with.

BRANCH EXCHANGE SWITCHBOARDS.

Cordless : Table Pattern with negative clearing.

All necessary switching operations are made by means of keys. Three sizes of negative clearing cordless switchboards have been supplied in the past, viz.:— $\frac{1+3}{4}$, $\frac{2+4}{6}$ and $\frac{3+7}{12}$ but later issues of cordless switchboards are arranged for positive clearing. Those equipped for negative clearing will be described first.

As already mentioned, Cordless boards are all of the table pattern. There is not a great amount of traffic to be handled, so that the operator can be engaged on clerical work and attend to calls without difficulty.

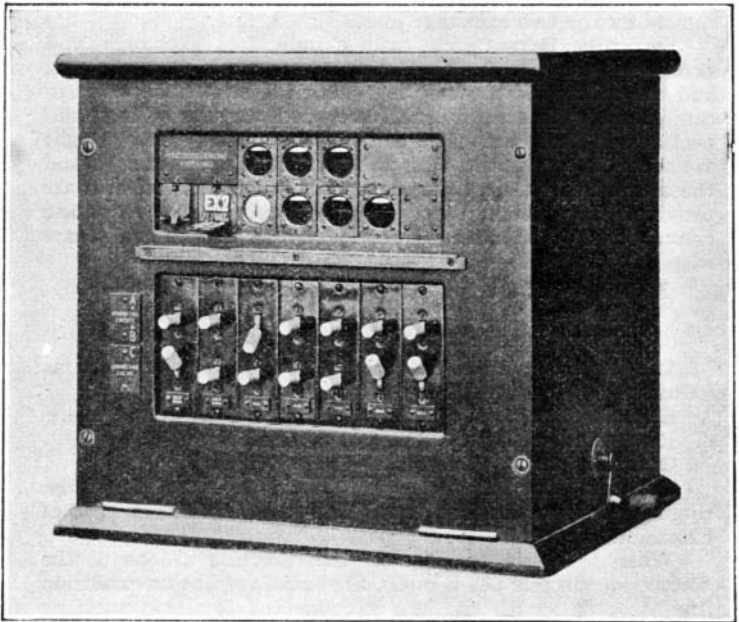

Fig. 1.

$\frac{2+4}{6}$ CORDLESS BOARD-NEGATIVE CLEARING.

Each switchboard consists of a rectangular wood box cut away where necessary to allow keys and indicators to be fitted and connections to be made. The front of the board is hinged, and opens outwards to enable the apparatus and wiring to be inspected. The outside is polished and suitably finished. A general view of a $\frac{2+4}{6}$ board is shown in Fig. 1. A C.B. table pattern instrument is provided for the operator's use.

An inspection of the face of the board reveals the following :—

At the top is a row of 3 signals of the eyeball pattern. These are supervisory signals and are associated with the three connecting circuits with which the board is provided. The 4 indicators of similar pattern immediately below the supervisory signals are the 4 calling signals for the 4 extension lines. In line with these on the left are two drop indicators, one of which is shown actuated. These are the calling signals for the two exchange lines.

Vertically below each calling indicator, exchange and extension, are two double-throw keys. Each pair of keys, and the calling indicator in alignment therewith, are wired in connection with one line and are used for controlling connections on that line. The pair of keys on the extreme right are wired in connection with the operator's telephone set and the alarm bell circuit. On the board illustrated, facilities are provided for setting up simultaneously three separate connections. The three connecting circuits A, B, and C are wired in parallel to—

- (A) the upper side of the top horizontal row of keys,
- (B) the lower side of the top horizontal row of keys,
- (C) the upper side of the lower horizontal row of keys.

The lower halves of the bottom row of keys function as follows :—

- Exchange line keys. Connect holding coil to exchange line.
- Extension line keys. Ring out on extension line.
- Operators' keys. Control night alarm bell.

The keys lock in all positions with the exception of the ringing positions on the lower half of the bottom row of extension line keys.

When a key is operated in the direction of one of the connecting circuits (A, B or C), the exchange line or extension line associated with the key is connected to the connecting circuit; if, now, a second key on the same horizontal row is operated in the same direction, the second line is connected to the same connecting circuit, *i.e.*, the two lines are put through to each other *via* the connecting circuit. The pairs of wires marked A, B and C in Fig. 2 form the connecting

SWITCHBOARD B.E., C.B., CORDLESS (NEGATIVE CLEARING)

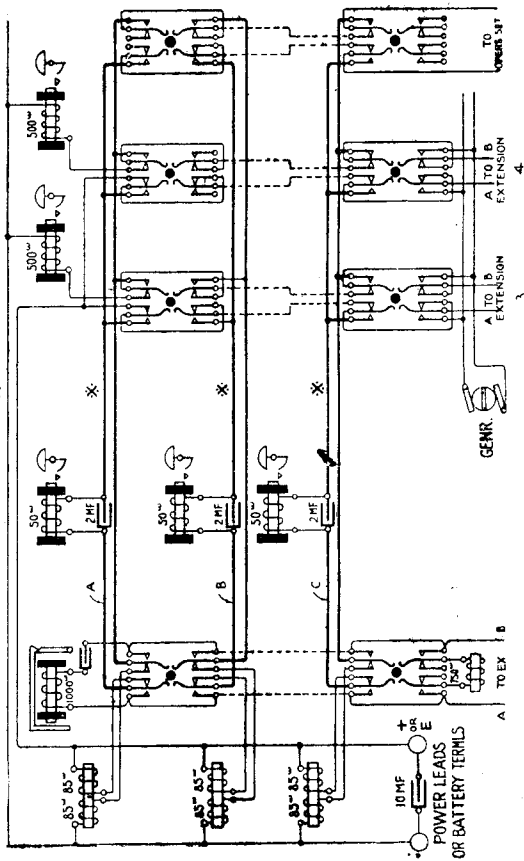

Fig. 2.

circuits. These are shown by thick lines to enable them to be traced more easily. Such a connecting circuit performs the same functions as a cord circuit on the Double Cord switchboards.

In order to explain the operating, consider what happens when an *incoming* call is made.

The operator at the main exchange inserts a plug in the multiple jack of the exchange line and then proceeds to ring out to line. The circuit is from the exchange to the *A* terminal of the exchange line through the 1,000th drop indicator, the 2 m.f. condenser, to the *B* terminal, and thence back to the exchange. The alternating current causes the armature of the indicator to vibrate and the drop is released and announces the call. In order to connect the exchange line to her instrument, the P.B.X. operator must choose a connecting circuit not already engaged. Assuming the circuit marked "B" to be free, the operator will depress the top key immediately under the indicator (the indicator shutter should be replaced at the same time), and she will also depress the key on the extreme right on the same row. By this means both the exchange line and the operator's instrument are connected to circuit "B". The receiver is now taken off its hook, the operator speaks to the

SWITCHBOARD B.E., C.B., CORDLESS (NEGATIVE CLEARING).

Extension through to Exchange.

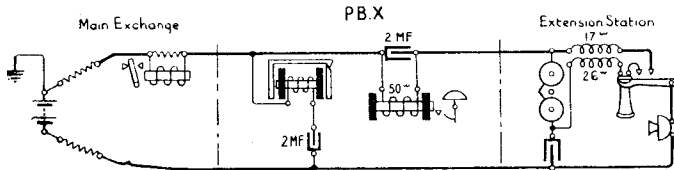

Fig. 3.

caller and ascertains which extension is required. The loop through the operator's transmitter holds the exchange line, and she should not leave the circuit until the extension has answered. She then depresses the lowest key corresponding to this extension, and at the same time turns the handle of the hand-generator fitted to the right of the board. The bell of the extension instrument is thus rung. The key in the top row corresponding to the extension line should be depressed so that, on releasing the ringing key, the operator can hear whether the extension has answered and see the call through. When communication is established, the operator moves her key (the right-hand key) to the normal position, thus dis-

connecting her instrument. The supervisory signal in the " B " connecting circuit will be operated as long as the extension is speaking. The connections whilst the call is in progress are shown diagrammatically in Fig. 3. The path of the current is from the positive pole of the main exchange battery along the *A* line of the operator's cord circuit, subscriber's line to P.B.X., through the supervisory signal (which it operates), the extension instrument and back to the *B* terminal of the exchange line, thence to the main exchange, through " B " line of the operator's cord circuit to the negative terminal of the main battery. It will be noticed that the supervisory signal at the Branch Switchboard is shunted by a 2 m.f. condenser which allows the fluctuations of the current which represent speech to be transmitted. Without the condenser, the inductive effect of the supervisory signal would tend to damp out these fluctuations. The following points should also be noted :—

(1) The path of the current from the main exchange is completed through the extension transmitter, enabling the extension to speak and signal.

(2) As long as the extension receiver is off the hook, the supervisory lamp at the main exchange is out, and the signal at the P.B.X. is operated. The exchange line is thus held. When the extension receiver is hung up, the former is lighted and the latter is placed out of action owing to the cessation of the current. In other words, clearing signals are given simultaneously at the main and branch exchanges.

(3) If the extension flashes, *i.e.*, moves the switch-hook up and down whilst the connection is still made, the supervisory signals at both main and branch exchange are actuated so that he cannot call in the P.B.X. operator without producing false signals at the main exchange.

Should an incoming call from the main exchange be received at the P.B.X. when the required extension is engaged, the P.B.X. operator, having answered the call as described, may ask the caller to hold the line. By throwing the bottom key of the exchange line into the down position a 750^{ohm} retardation coil is connected across the exchange line. The latter is thus held and the operator is free to carry on.

The operations for an *outgoing exchange call* should now be obvious.

Consider now a *call from one extension to another*. The extension, say No. 3, takes his receiver off its hook, thus completing the following circuit through his transmitter (*see* Fig. 2) :—Positive terminal of battery, through the inner and main spring contacts of the keys associated with No. 3 extension, *A* line of extension circuit, extension transmitter, *B* line of extension circuit, key contacts, line indicator of No. 3 exten-

sion, negative terminal of battery. The current operates the indicator, bringing the eyeball down. The operator answers the call and makes the connection just as in the previous case, care being taken to select a disengaged connecting circuit. The connections whilst the call is in progress are shown diagrammatically in Fig. 4. The following points should be noticed :—

(1) The current for signalling and speaking is supplied either from a local primary battery or by means of a power lead from the main exchange battery. In the latter case, it is only necessary to connect the negative pole of the battery ; the positive, being earthed, can be obtained by means of a suitable earth, such as a water main, on the P.B.X. premises.

(2) The positive and negative poles of the battery are connected each through the 85^w coil of an $85^w + 85^w$ retardation coil

SWITCHBOARD B.E., C.B., CORDLESS (NEGATIVE CLEARING).

Extension through to Extension.

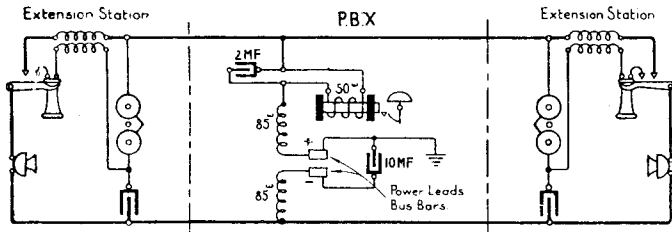

Fig. 4.

and the terminals of the battery are bridged by a 10 m.f. condenser. This combination prevents overhearing between one circuit and another, *e.g.*, when two pairs of extensions are connected.

Night Facilities.—It will be observed that on this type of board the normal connecting arrangements can be utilised for joining any extension through to an exchange line for night service after the P.B.X. operator has left. The only additional operation necessary is to “throw” the alarm bell disconnecting key before leaving the board.

Cordless Switchboard with Positive Clearing.

Loose Leaf Diagram N. 936 and N. 937.

This board is an improvement on the original type of cordless board just described and is now the Department's **standard design**. The principal innovation consists in arranging for the signals associated with the extension lines to act in the dual rôle of calling signal and supervisory signal. Two distinct

advantages are obtained from this dual use of the extension line indicators ; *firstly*, a positive supervisory signal associated with an audible alarm circuit is obtained and, *secondly*, the supervisory signal is always vertically in line with the key controlling the line to which the signal refers, so that the operator can instantly sever a connection or enter into circuit in response to a signal without any mental effort to determine which is the proper key to operate.

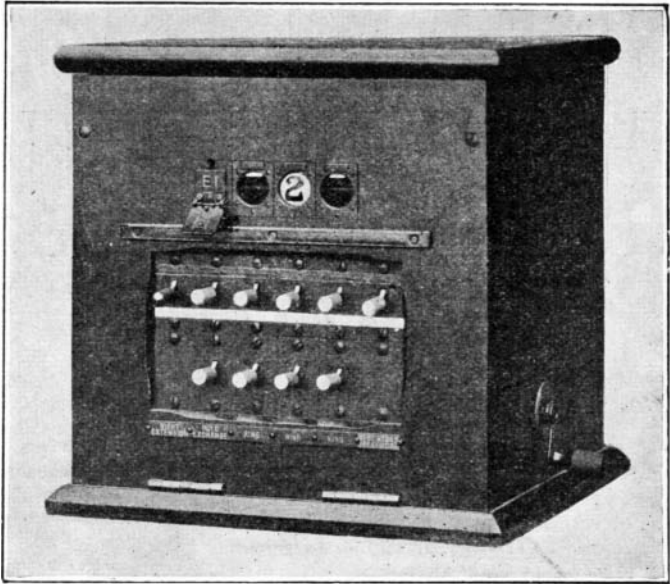

Fig. 5.

$\frac{1+3}{4}$ CORDLESS BOARD-POSITIVE CLEARING.

A photograph of a $\frac{1+3}{4}$ board is shown in Fig. 5. The board is similar in general appearance and method of operation to the board with negative clearing. The circuit arrangements are illustrated in Fig. 6. For the sake of simplicity only one exchange line, two extensions and one set of connecting keys are shown ; the connections of the other groups of keys which make up the full complement of the board (as shown in Loose leaf Diagrams N. 936 and N. 937) merely duplicate the

SWITCHBOARDS, BRANCH EXCHANGE C.B., CORDLESS
(POSITIVE CLEARING).

Circuit Diagram.

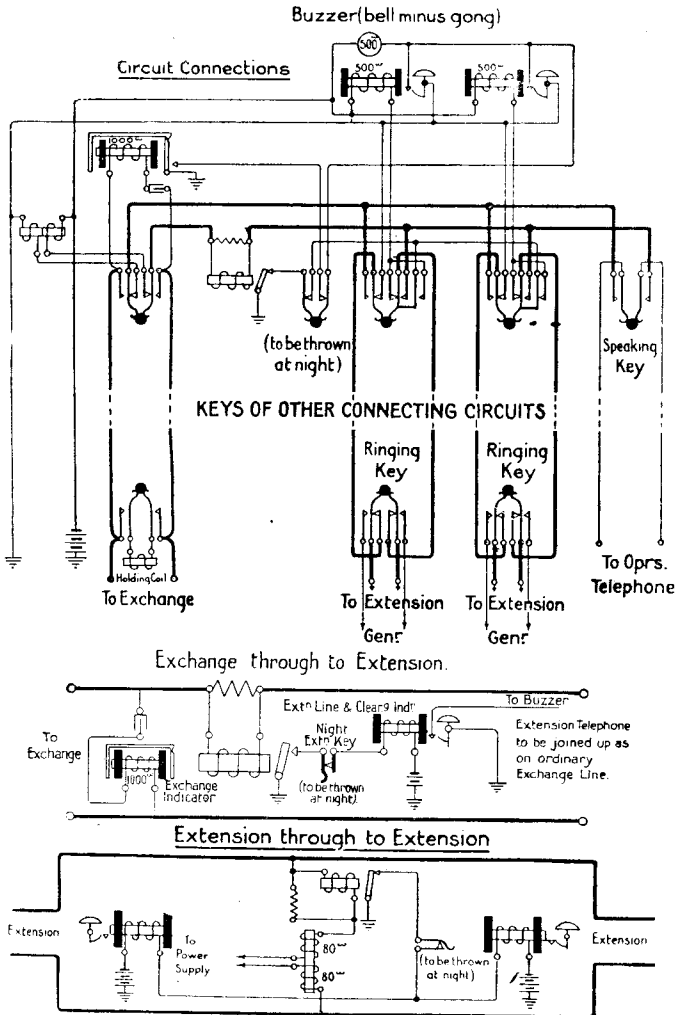

Fig. 6.

connections shown in Fig. 6. It will be seen that a series relay is inserted in each connecting circuit in place of the eyeball indicator on the earlier boards, and that this relay controls the operation of the extension line indicator when the latter has been transferred to the connecting circuit by the operation of a connecting key. When all the connecting keys on an extension line are in the normal position, the indicator circuit is completed from the negative pole of the battery or power lead, through the winding of the signal, across the inner contacts of the connecting keys, to the *B* line of the extension circuit. The *A* line of the extension circuit is connected to earth on the battery or power lead *via* the inner contacts of all the connecting keys on that line. When the extension station receiver is taken off the hook, current flows round the subscriber's loop and energises the calling signal. When a connecting key on an extension line is "thrown," the indicator circuit is completed from the negative pole of the battery, through the winding of the signal, across the outer contacts of the connecting key which has been "thrown" and whose inner contacts are therefore broken, across the contacts of the night extension key, to earth *via* the resting contact and armature of the series relay in the connecting circuit. During conversation this relay is operated and the indicator circuit is broken. When the receiver at the extension station is replaced, this relay is de-energised and the signal is operated, thus giving a positive clearing signal. All signals on this board operate an alarm bell connected to their local contacts.

It should be noted that when an extension is connected to another extension, the clearing signal is not received until the receivers at both extension stations have been replaced. This feature is common to both types of cordless board.

Night Facilities.—For night service, arrangements are made to enable one extension to be connected to each exchange line and to obtain exchange service independent of the P.B.X. To this end, as many connecting circuits as there are exchange lines are provided with an extra key fitted at the extreme left of the row of keys which give access to the connecting circuit concerned. When "thrown" this key disconnects the alarm bell and intercepts the earth which the series relay in the connecting circuit applies to the extension line indicators, so that the indicator on the night service extension line is rendered inoperative.

DOUBLE CORD BOARDS.

The great advantage of the cordless type of board is the saving effected by having no cords to repair. As the boards are increased in capacity this advantage is outweighed by the

extra costs of wiring and the number of keys required. Consequently, if a board larger than the $\frac{3+7}{12}$ cordless is required, a double cord board is used. These boards are now supplied in the following sizes: $\frac{3+10}{25}$, $\frac{5+20}{25}$, $\frac{10+30}{65}$ and $\frac{10+50}{65}$.

The 25 *line boards* are floor type switchboards designed for fixing against a wall. The 65 *line boards* are ordinary floor pattern boards. The $\frac{1+4}{5}$ wall type switchboard is no longer being issued but several are still in use.

Switchboard B.E., C.B. $\frac{1+4}{5}$ Wall Pattern.

This switchboard is no longer being issued, but as a large number are still in use the following description is given. It was originally designed as a "B line feeding board," *i.e.*, current for operating the board and the extension instruments was drawn over the B line of the exchange circuit. This scheme of working proved unsatisfactory and the boards were re-arranged for a power lead feed or a local battery supply in common with all the other types of boards.

The circuit connections are illustrated in Loose Leaf Diagrams N. 934 and 935. The exchange line has a 1,000^w drop indicator bridged permanently across it and terminates on two plugs wired in parallel. Connections are made by inserting one of these plugs in the jack of the extension line required. There is no exchange line jack. The extension lines are equipped with 500^w eyeball signals and series relays, a separate ringing key being provided for each extension line. When there is no plug in the extension line jack, the removal of the receiver at the extension line station actuates the calling eyeball signal, the circuit being from the negative of the power lead or battery, through the signal, *via* the resting contact of the series relay and the extra springs on the jack, to the A line and back along the B line to earth *via* the inner contact of the jack and a common 100^w bridging coil. When there is a plug in the extension jack, the eyeball signal is cut adrift from the line and is joined directly across the power lead or battery *via* the resting contact of the series relay and the outer contact of the jack. In these circumstances it serves as a supervisory signal controlled by the series relay in the extension line. The operator's telephone consists of a standard C.B. instrument connected to a special jack marked "Telephone Jack." A second additional jack connected to a 400^w retardation coil is provided for holding the exchange line when necessary.

The operation of an *incoming exchange call* is as follows :— The exchange line indicator drops, and the operator inserts one of the exchange line plugs into the telephone jack and answers. She next inserts the second exchange plug into the jack of the required extension line and depresses the extension line ringing key and rings, the exchange line meanwhile being "held" by her instrument loop. When the extension answers, the first exchange plug is withdrawn from the telephone jack, leaving the extension through on the second plug. When the extension receiver is hung up, a clearing signal appears simultaneously at the main exchange and the P.B.X.

For answering extension calls a pair of "straight through" cords are provided. One plug of these is inserted in the jack of the calling extension and the other into the telephone jack. If another extension is wanted, the second plug is shifted from the telephone jack to the jack of the required extension and the latter rung by depressing the associated ringing key. If an exchange connection is required, the second plug is withdrawn from the telephone jack and an exchange plug inserted in its place. When the exchange answers and connects the required subscriber, the second exchange plug is put into the jack of the waiting extension in place of the extension to extension plug.

It will be observed that current is fed on to the extension to extension connecting cords through a retardation coil. Current for exchange calls is, of course, drawn over the exchange line in the usual way.

Night Facilities.—An extension requiring night service is connected through a special break jack at the point marked with crosses in Loose Leaf Diagram N. 934, Fig. 1. The insertion of an exchange plug into this jack cuts out all the normal equipment associated with the extension line and connects the plug directly to the outgoing extension line. The extension line is thereby converted into a direct exchange line for the time being. The exchange line indicator at the P.B.X. is still in bridge, but this does not matter.

$$\text{Switchboards C.B. 873 } \frac{3 + 10}{25} \text{ and } \frac{5 + 20}{25}$$

These two boards are similar, differing only in the amount of equipment. The additional equipment up to the maximum capacity can be added at any time as required. A photograph of a $\frac{5 + 20}{25}$ board is shown in Fig. 7. The circuit arrangements of the board are very similar to those of the cordless board with positive clearing on the line indicators, *i.e.*, the

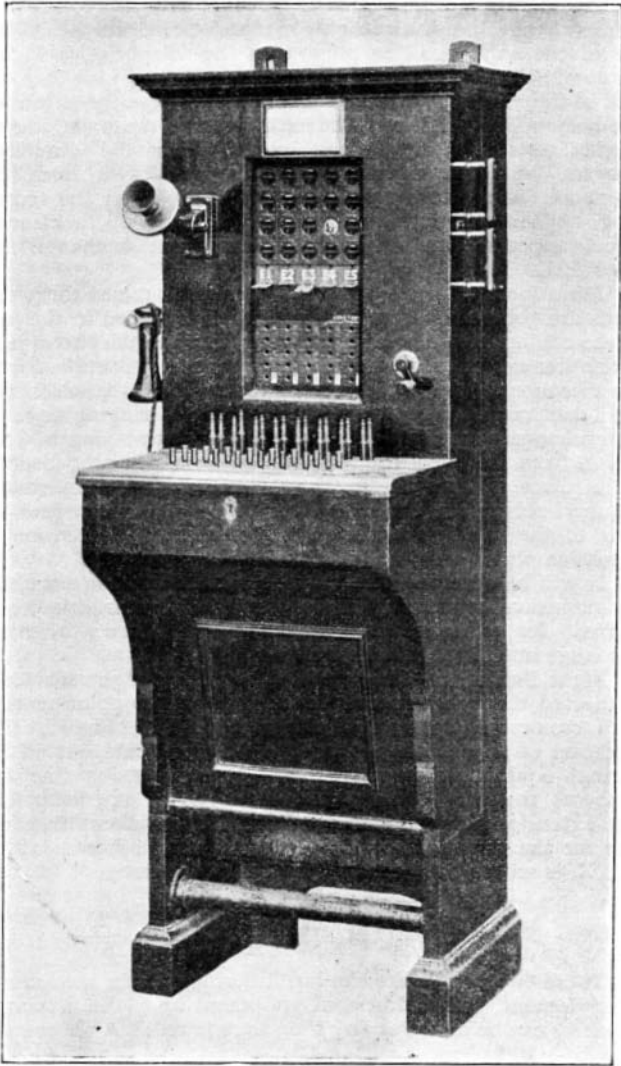

Fig. 7.

$\frac{5 + 20}{25}$ DOUBLE CORD BOARD.

extension calling signals are also used as supervisory signals when an extension is connected. This feature is an advantage, since a board of this size may not warrant the undivided attention of the operator, and all the signals, being in the face of the board, can be seen from a distance. The circuit connections for the exchange lines, extension lines and cord circuits are shown diagrammatically in Loose Leaf Diagram N. 930. $\frac{3 + 10}{25}$ board has 5 cord circuits which can be increased to 10 when the board is fitted to its maximum capacity.

The service transmitter is mounted on the board. The receiver, when not in use, hangs on a switch-hook, also fitted on the board.

In order to follow the method of working the board, consider *an incoming call from the main exchange*. The operator at the latter sends ringing current out to line, thus dropping the $500^w + 500^w$ indicator which is connected in series with a 1 m.f. condenser across the line. When the shutter drops it completes the bell circuit, and a trembler bell mounted on the board rings, thus announcing the call. The bell circuit is broken when the receiver is taken off the switch hook. The P.B.X. operator answers the call by inserting the answering plug of a pair of disengaged cords in the exchange line jack vertically below the indicator which has been dropped. She then throws forward the listening key belonging to the cord circuit and speaks to the caller. She also replaces the indicator shutter. Next, she inserts the calling plug in the jack of the extension required and rings the latter by pulling the key towards her.

The following points should be noted :—

(1) When the answering plug is inserted in an exchange jack a circuit is made from the negative of the battery (or power lead), through a 1000^w relay in the third conductor of the cord, to the sleeve of the answering plug, the bush of the exchange line jack, and thence to earth through a pair of contacts on the night extension key. The 1000^w relay is actuated, cutting off the battery supply to the P.B.X. cord circuit. Speaking current is now supplied for the extension from the main exchange.

(2) The exchange line is not held until the P.B.X. operator "throws" her listening key, when the loop through her transmitter operates the supervisory relay at the exchange. When the extension is being rung, the exchange line is held by a 100^w coil which is bridged across the cord circuit through a pair of contacts on the ringing key. After ringing, and until the extension station replies, the exchange

line is held by the 500^w eyeball signal of the extension line which is bridged across the line until the extension answers, when its circuit is broken by the supervisory relay.

(3) While the conversation is in progress, the exchange line is held by the loop through the extension transmitter. The supervisory relay is actuated and the eyeball signal disconnected.

(4) When the receiver at the extension is replaced, the supervisory relay in the extension line is released. This results in the eyeball signal being again placed in bridge across the line. The current from the exchange line operates the signal, thus giving a positive clear to the P.B.X. operator, but the 500^w loop across the line prevents the clear being given at the main exchange. This latter feature of the circuit enables the extension station to call in the P.B.X. operator for the purpose of transferring a call to another extension without producing false signals at the main exchange.

(5) When, in response to the clearing signal, the P.B.X. operator takes down the connection, all "loops" across the exchange line are removed, and the clearing signal is given to the main exchange.

Consider now a *call from one extension to another*. An extension signals by taking his receiver off its hook. A circuit is thus completed from the negative pole of the battery (or power lead) through a pair of contacts on the extension jack to the eyeball signal; thence along the *B* line, through the extension transmitter, and back along the *A* line to earth on the inner spring of the extension jack. When the answering plug is inserted the conditions are similar to those in the previous case, with this exception, viz., there are no connections on the bushes of the extension jacks. The 1,000^w relay in the cord circuit is, therefore, not actuated, and the current for speaking and signalling is now fed from the local battery or power lead through the 80^w + 80^w retardation coil.

Night Facilities.—Each extension requiring night facilities is connected to an exchange line in the usual way, and the night extension keys are "thrown." On referring to Diagram N. 930, it will be seen that these keys cut off the bell, supervisory signals and the local battery or power lead supply to the cord circuits.

Switchboards C.B. 887 $\frac{10 + 30}{65}$ and $\frac{10 + 50}{65}$ Floor Pattern.

A photograph of fully equipped board is given in Fig. 8. The $\frac{10 + 30}{65}$ has 11 pairs of cords, which can be increased to 15 when the equipment is increased to 10 + 50.

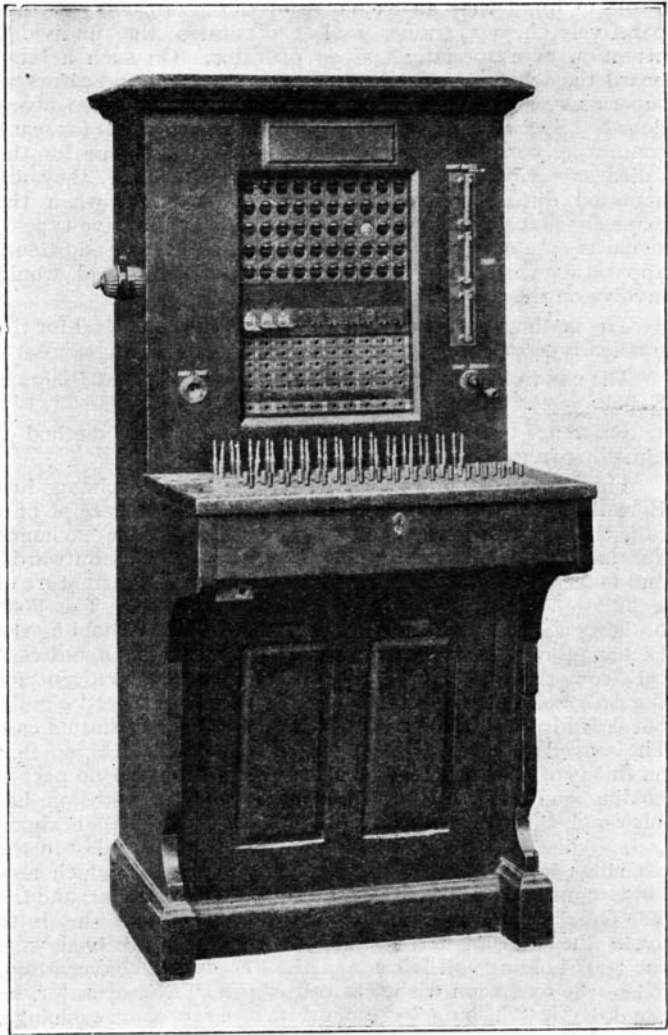

Fig. 8.

$\frac{10 + 50}{65}$ DOUBLE CORD BOARD.

In considering the design of this board, it should be borne in mind that an exchange of this size carries a comparatively heavy traffic, and necessitates the undivided attention of a specially trained operator. On such a large board the scheme of utilising the extension line indicators as supervisory signals would be unwieldly, and has been abandoned. Special supervisory signals are provided for each connecting cord circuit, one for the calling and one for the called subscriber. These signals are negative, *i.e.*, they are actuated during conversation, and are released when the extension station receivers are hung up. The negative type of signal is employed to avoid the complications and additional apparatus which the provision of a positive signal would involve on these boards.

The method of operating is similar to that described for the smaller type of board.

The circuit arrangements are shown in Loose Leaf Diagram N. 932.

Reference to Fig. 1, N. 932, will make clear the method of signalling from the extension.

Fig. 2, N. 932, shows the connections for an exchange line. Here the conditions are somewhat different. On receipt of a call, the operator inserts an answering plug in the exchange line jack. The extra spring on the jack is pressed outwards, and makes contact with a spring connected to the armature of a $20^w + 30^w (= 12^w)$ relay in the line circuit. The 300^w bridging coil is now in circuit across the line, thus holding the exchange (or calling the exchange in the case of an outward call from the P.B.X.). It should be noted that current for the operator's transmitter is not drawn from the cord circuit, but is fed locally from the bus-bars through a retardation coil. The secondary circuit includes a condenser in series, so that on this type of board the operator's telephone plays no part in holding the exchange line. Thus, until the extension has answered, the exchange line is held solely by the 300^w bridging coil. When the extension answers, however, the relay in the exchange line circuit is operated by the current which now flows round the loop through the extension transmitter, and the 300^w holding coil is disconnected. The object of this is to avoid the transmission loss which would be involved were the 300^w holding coil left across the line during conversation. When the extension wishes to call in the P.B.X. operator, he can do so by "flashing" without disturbing the main exchange, as the latter is always held either by the extension loop or by the 300^w bridging coil. From reference to the cord circuit Diagram N. 932, Fig. 4, it will be seen that the supervisory signals are actuated while a call is in progress, a disc being

brought into view. On an exchange call, the extension, by depressing and releasing the switch-hook, will cause both answering and calling supervisory signals to be operated, the discs disappearing at each depression of the switch-hook. On a local call, each extension can operate independently his own supervisory signal.

It should be noted that the two supervisory signals in each cord circuit are bridged by a 2 m.f. condenser in order to maintain the speech transmission.

A ring-back key is fitted in connection with each pair of connecting cords. It is non-locking, and enables the operator to ring on the answering side of the cord circuit, a convenience which obviates the necessity of changing cords when it is necessary to ring-back the calling subscriber.

A hand-generator is supplied, but in the larger boards where traffic is heavy a special ringing lead is brought in from the main exchange. A locking key near the right-hand end of the keyboard is provided, so that, in the event of failure of the power from any cause, the hand generator can be brought into circuit.

Other details of this type of board are similar to those in the $\frac{5+20}{25}$ board, or are sufficiently obvious after previous explanations to make further description unnecessary.

Long Line Equipment.—The presence of retardation coils in the battery feeds to the cord circuits (*see* N. 932) has an important effect on the signalling conditions on extension to extension connections. Their resistance limits the amount of current which can be drawn from the power lead or local battery supply to any cord circuit. This limited current on reaching the cord circuit divides between two paths, one portion flowing through the answering supervisory signal on to the circuit connected to the answering plug and the other portion flowing through the calling supervisory signal on to the circuit connected to the calling plug. The magnitude of the currents flowing in the two paths will be inversely proportional to the resistances of the two extension circuits, *e.g.*, if the total resistance from the centre of the cord circuit to the calling extension, including the instrument loop, is 100 Ω , and from the same point up to and including the called extension is 200 Ω , then *two-thirds* of the current will flow round the calling extension and *one-third* round the called extension. So long as the extensions on the P.B.X. are all short there is only a small variation in their resistances, and the current divides fairly equally. When, however, longer extensions are connected, difficulties are experienced on account of inequality in the resistances connected to the

two sides of a cord circuit when a long extension is put through to a short one. The bulk of the current flows round the short extensions, leaving insufficient in the long one to operate the supervisory signal. This difficulty is obviated by fitting a special equipment in the long extension line. This is a device which, operated over the high resistance extension line, substitutes a low resistance loop comparable with a short internal extension, to control the P.B.X. supervisory signal, and so secures a more even division of the current between the two halves of the cord circuit.

The equipment is illustrated in Loose Leaf Diagram N. 938. It consists essentially of a repeating coil inserted in the extension line circuit between the line and the switchboard termination. On the line side of the repeater, current is fed to the extension line through the coils of a double wound sensitive relay. This relay is operated when the receiver at the extension station is removed from the switch-hook, and bridges the condenser on the exchange side of the repeater with a 40^w resistance spool, thus controlling the supervisory signal or the calling signal on the P.B.X. board. It should be noted that the relay is not operated by ringing current, otherwise, when the extension was put through at the P.B.X. for night service, the keyless or machine ringing at the main exchange would be tripped before the extension bell could be rung. The circuit arrangements shown on N. 938, Fig. 1 are adopted when the total resistance of the exchange line plus the long extension line exceeds the limit allowable for C.B. speech to the main exchange, and a local battery instrument has to be employed at the extension station.

If the combined resistance of the exchange and extension line is within the limit allowable for C.B. working, a C.B. telephone is fitted at the extension and a long line equipment is used, in accordance with Loose Leaf Diagram N. 938, Fig. 3. This equipment is designed on similar lines to that illustrated in N. 938, Fig. 1, except that a $100^w + 100^w$ relay is substituted for the $1,000^w + 1,000^w$ in order to permit sufficient current to pass to operate the C.B. transmitter on extension to extension calls. A 500^w relay connected to the bush of the extension line jack, and operated by the earth on the bush of the exchange line jack, cuts out the repeater when an exchange connection is made and leaves the extension transmitter to be fed with the C.B. current drawn over the exchange line.

INSTALLATION.

In practice each case should be considered separately, but there are a few guiding principles of general application which should be adhered to.

Position.—This should be such that the front of the board is well lighted by natural light if possible, and also by artificial light when required. Noises should be avoided as far as possible. Small boards will generally be fitted in an office where other work is being carried on, and a separate room is usually unnecessary. For the larger boards, where an operator is in continuous attendance, it is an advantage to have a suitable space partitioned off. In no case should a board be fitted in a workshop.

Cabling.—For small boards, the conditions are similar to those met in wiring instruments, and no special instructions are necessary. For the larger boards the cable runs must be considered on the spot. Special chases may have to be constructed to convey the cables to a suitable distribution point for connecting to the extensions. When the latter are external, protective apparatus will be fitted. If a local battery is used, a suitable position must be found for it, and also for the case for condensers, etc. Special care should be taken that all soldered connections are good, and the forming and lacing of cables should be carried out neatly.

Earth Connection.—The earth connection may be made to a water main if available. Failing this, an earthplate will have to be sunk.

TESTING OUT.

On completion of fitting, an ordinary working test, including cord circuits and bell or buzzer, should be made, and any defects remedied. The Test Clerk at the main exchange will then be asked to test the exchange lines. This test will include transmission, insulation, conductivity, calling signals, and holding coils. Faults will be noted during the test, and proved whether *in* or *out* of the subscriber's premises. The extensions will then be tested. A good exchange line having been selected, it will be connected to each extension in turn, using the "night extension" method. The Test Clerk will then test the transmission, insulation, conductivity, and ringing as for an ordinary exchange line. A fitter will attend at each extension in turn.

MAINTENANCE.

Cordless boards should give little trouble when once properly installed. When a fault develops, a few enquiries from the P.B.X. operator will give the faultsman any necessary data to work on. A fault on an exchange line can be quickly localised with the help of the Test Clerk. If found to be inside, an examination of the wiring and soldered connections

will probably reveal it. Key springs should be examined to see that they make proper contact when the key is normal and operated. A switchboard lamp or receiver can be used for localising faults; a disconnection can readily be located by tapping across the affected line with either of these. A fault affecting several circuits may be looked for in the board, *e.g.*, a faulty connecting circuit would appear every time that particular circuit was brought into use. A disconnected or earthed power lead would put the whole system out of order, so also would a disconnected earth. Noises or cross-talk on all local calls would probably be caused by a faulty condenser across the power lead and earth.

Double Cord Boards.—The chief maintenance item is the upkeep of the cords. The P.B.X. operator should test these each day before traffic commences. On the larger boards a special jack is used for testing. The plug is inserted in this jack and the cord shaken whilst the operator listens in. A crackling or scraping sound means a faulty cord. Also, the loop across the testing jack should operate the supervisory signal, and each signal should be watched to see that it is in order. On the smaller boards the cords can be tested by inserting each in turn in the jack connected with the operator's instrument. Noisy cords or faulty supervisory signals will be noted and reported for attention.

In all cases where the clearing of a fault necessitates interfering with the wiring of the board, care should be taken that it is left in its original condition. If temporary wiring has to be resorted to, it should be made good at the earliest opportunity. Neglect of these precautions soon brings the wiring into an untidy condition and makes the localisation and clearing of later faults increasingly difficult. Relay and jack springs may occasionally require adjustment. When this is being done, the spring should be bent at a point as near the fixed end of the spring as possible.

Faults appearing only at night may usually be traced to an extension which is left through to the exchange at night. For example, a low insulation might not cause trouble during the day, and yet might be sufficient to interfere with signalling when the affected line is connected to the main exchange.

Generally, the speedy location of a fault is a matter of experience, and a thorough working knowledge of each type of board is essential.

SWITCHBOARD B.E.C.B.

N.930. 23.2.23
C.B.873^F Supersedes No. 931

$\frac{3+10}{25}$ & $\frac{5+20}{25}$

CIRCUIT CONNECTIONS.
 FOR WIRING DIAGRAM SEE C.B.874.

FIG. 1. EXTENSION.

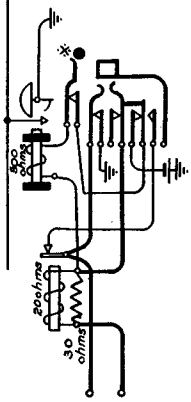

FIG. 2. EXCHANGE LINE.

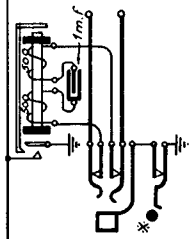

FIG. 3. NIGHT ALARM.

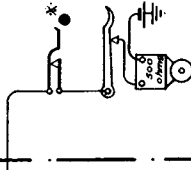

FIG. 4. HOLD JACK & CORD TEST.

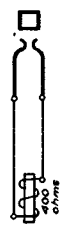

FIG. 5. OPERATORS TELEPHONE.

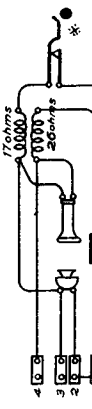
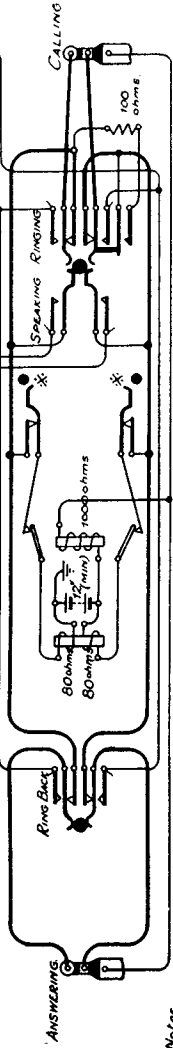

FIG. 6. RINGING C.C.T.



FIG. 7. CORD CIRCUIT.



Notes.

- * INDICATES CONTACTS ON NIGHT SWITCHING KEY.
2. WHEN POWER RINGING IS PROVIDED ALTER RINGING CIRCUIT TO C.B.894. FIG. 2

N.932^A 8.3.23

SWITCHBOARD B.E. C.B. $\frac{10+30}{65}$ & $\frac{10+50}{65}$
 CIRCUIT DIAGRAM.

C.B.887^D

Supersedes N.933

FOR WIRING DIAGRAM SEE C.B.886.

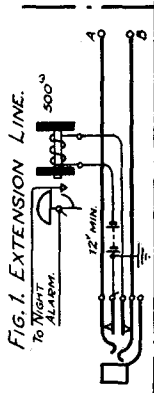

FIG. 1. EXTENSION LINE.

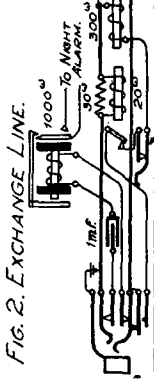

FIG. 2. EXCHANGE LINE.

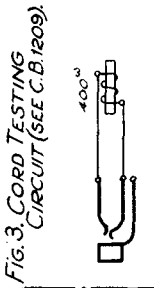

FIG. 3. CORD TESTING CIRCUIT (SEE C.B.1209).

FIG. 4. CORD CIRCUIT.

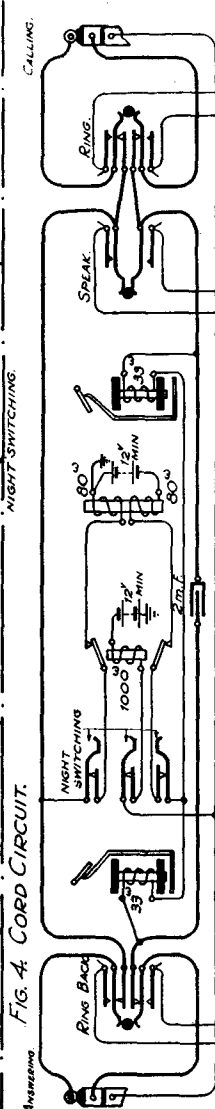

FIG. 5. OPERATORS TELEPHONE.

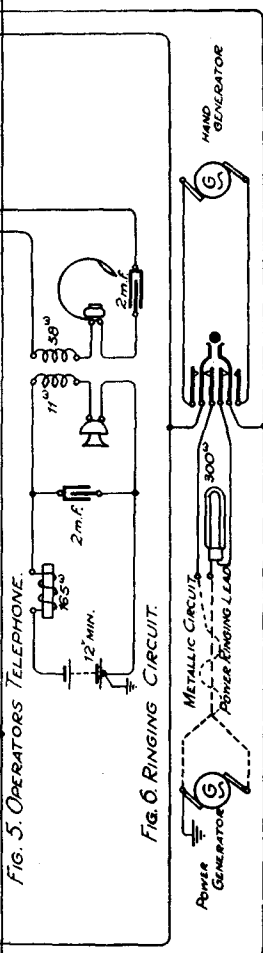

FIG. 6. RINGING CIRCUIT.

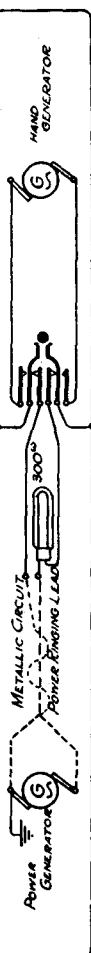
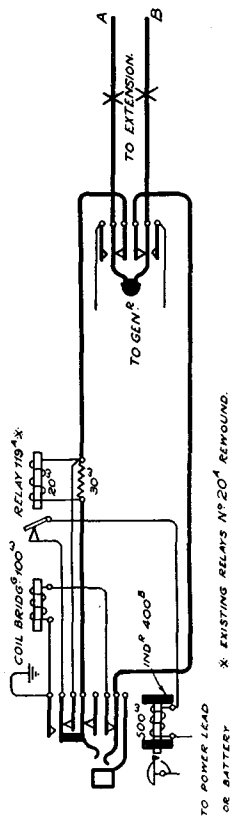

FIG. 6. RINGING CIRCUIT.

B.E. C.B. SWITCHBOARDS. $\frac{1+4}{5}$
 EXTENSION & EXCHANGE LINES.

FIG. 1. EXTENSION LINES.



X EXISTING RELAYS N°20^A REMOVED.

FIG. 2. EXCHANGE LINE.

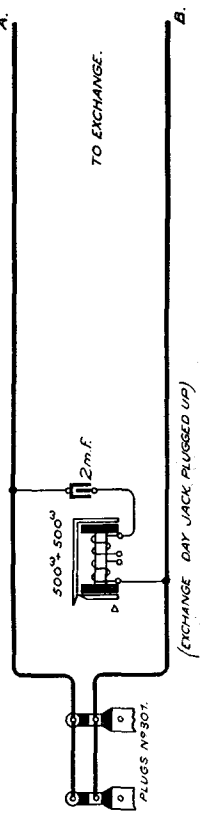

B.E.C.B. SWITCHBOARDS $\frac{1+4}{5}$
CONNECTING CORDS & OPERATOR'S CIRCUIT.

N. 935. 28.6.17
C.B. 892.

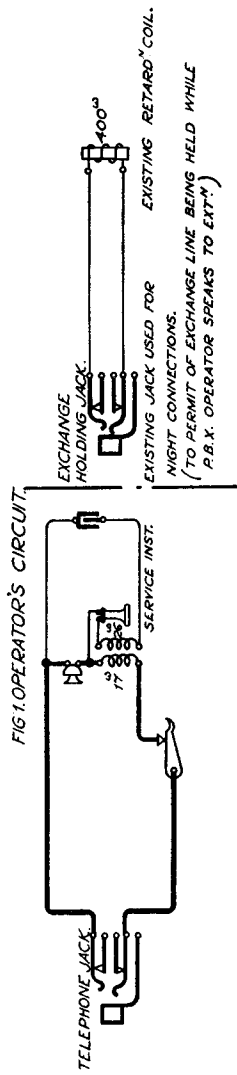
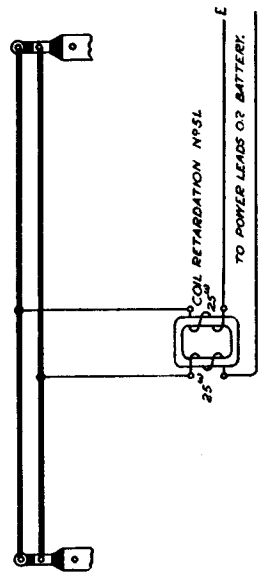

FIG. 2. CONNECTING CORDS FOR EXT^N TO EXT^N CONVERSATION.



ADDITIONAL PAIRS OF CONNECTING CORDS WOULD BE PROVIDED FED THROUGH 20 Ω -20 Ω MEGA RETARDATION COILS IF REQUIRED.

SWITCHBOARD B. E. C. B. CORDLESS.
 POSITIVE CLEARING.
 CIRCUIT CONNECTIONS.

N.936 23.7.17
 C.B.935. D (Sheet 1)

FIG. 1.

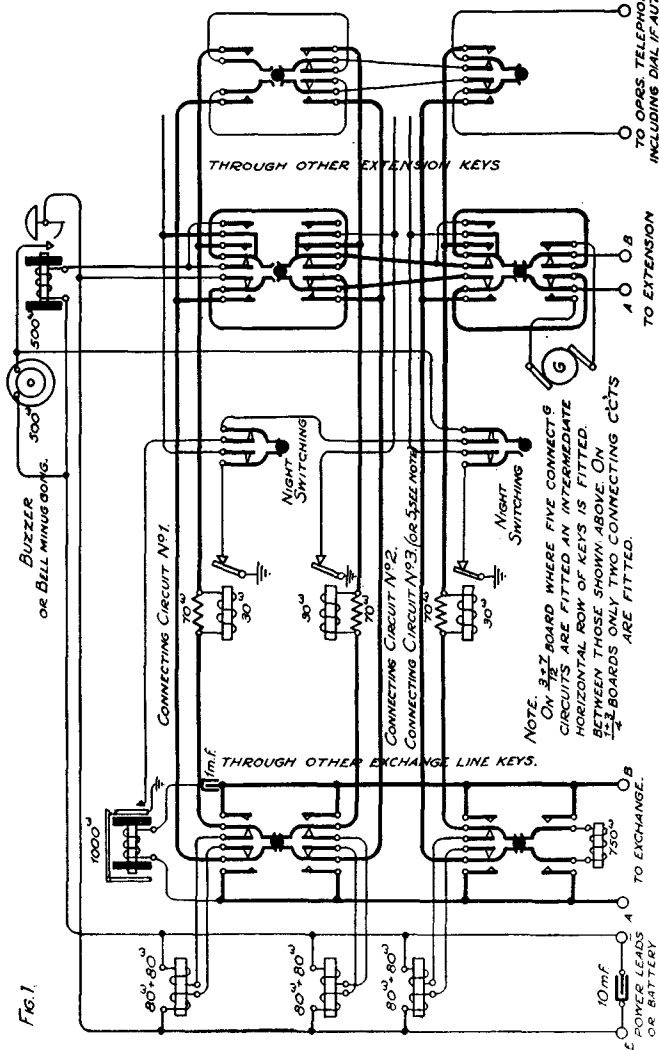

SWITCHBOARD B.E. C.B. CORDLESS.
 POSITIVE CLEARING
 EXPLANATORY DIAGRAMS.

N.937 5.7.17

C.B.935.^D (Sheet 2)

FIG. 2. EXCHANGE THROUGH TO EXTENSION.

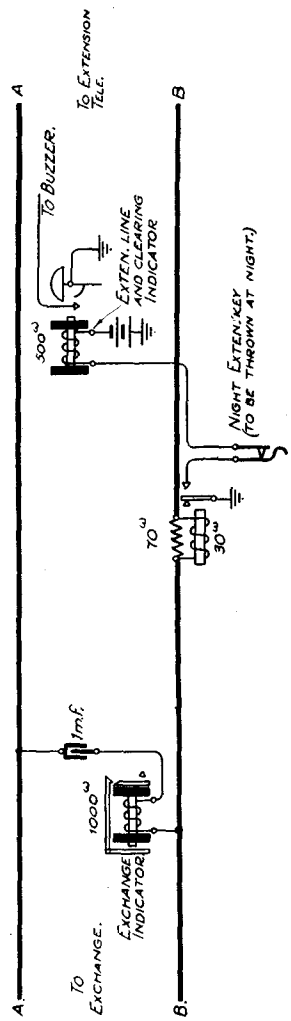
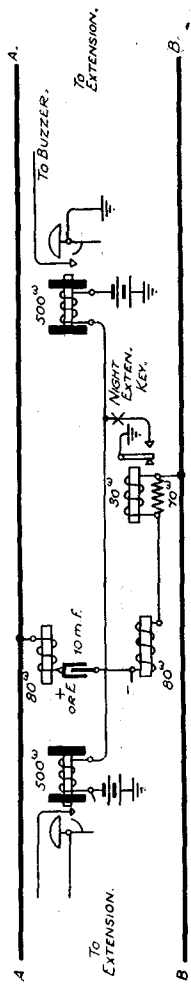

FIG. 3. EXTENSION THROUGH TO EXTENSION.



UNIT, AUXILIARY APPARATUS N°18

FOR LONG EXTENSIONS & LONG PRIVATE WIRES ON A.T. & C.B. BRANCH
EXCHANGE DOUBLE CORD SWITCHBOARDS.
EXPLANATORY DIAGRAM.

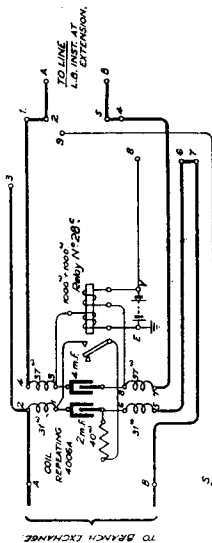

FIG. 1. AS ISSUED. IS USED FOR EXTENSIONS.

On switchboards with hand restored indicators for clearing on extras over 50^m With Relay N°19 Fig 2000 in cord sets for clearing an extra over 50^m With indicators N°6004 in cord sets for clearing an extra over 100^m With indicators N°6002 in cord sets for clearing an extra over 100^m With indicators N°6002 in cord sets for clearing an extra over 100^m With indicators N°6002 in cord sets for clearing an extra over 150^m N.B. Where the total max under each, to 4.5th condition permits of C.B. speaking see Fig. 3.

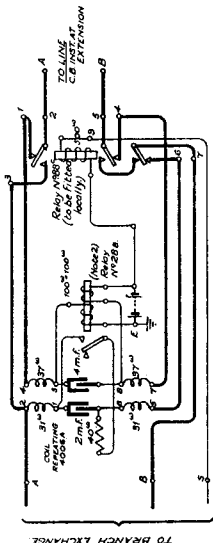

FIG. 3. As modified for EXTENSIONS on switchboards with hand restored indicators, to cut out long line equipment on exchange connections when transmission requirements permit the use of C.B. telephones in such conditions.

N.938^A
C.B.962^H

Supersedes N.939 & N.940

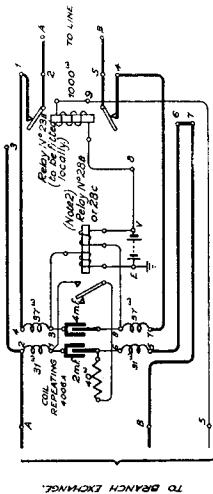

FIG. 2. As modified for PRIVATE WIRES exceeding the limits quoted in Fig. 1 on switchboards with hand restored indicators to prevent intercommunication with main exchange.

GENERAL NOTES.

1. Relays 28^a and 28^c do not operate with ringing current under these conditions.
2. The 1000-1000 relay supplied with the unit is to be replaced locally by a 1007-1007 relay when transmission requirements permit the use of a C.B. telephone at the out station.
3. Figs 2 & 3 are not applicable to switchboards with self restoring indicators.
4. The capacity between repeater terminals 1 & 6 cannot be increased beyond 2 m.f. without risk of prematurely tripping machine ringing at the main exchange on night connections.
5. If necessary to provide for efficient ringing through these units four magnet generators will be provided at the P.B.X.
6. It is intended that the unit be mounted vertically on a wall or other suitable support.
7. For termination of private wires on N°9. Multiple Switchboards see separate diagram.

LIST OF Technical Pamphlets for Workmen

(Continued)

GROUP E.

1. Automatic Telephony. Step by Step Systems.
2. Automatic Telephony. Coder Call Indicator(C.C.I.) Working.
3. Automatic Telephony. Keysending " B " positions.

GROUP F.

1. Subscribers' Apparatus C.B.
2. Subscribers' Apparatus C.B.S. Part I—C.B.S. No. 1 System.
3. Subscribers' Apparatus Magneto.
4. Private Branch Exchange—C.B.
5. Private Branch Exchange—C.B. Multiple, No. 9.
6. Private Branch Exchange—Magneto.
7. House Telephones.
8. Wiring of Subscribers' Premises.

GROUP G.

1. Secondary Cells, Maintenance of.
2. Power Plant for Telegraph and Telephone Purposes.
3. Maintenance of Power Plant for Telegraph and Telephone Purposes.
4. Telegraph Battery Power Distribution Boards.

GROUP H.

1. Open Line Construction, Part I.
2. Open Line Construction, Part II.
3. Open Line Maintenance.
4. Underground Construction, Part I.
5. Underground Construction, Part II.
6. Underground Maintenance.
7. Cable Balancing.
8. Power Circuit Guarding.
9. Electrolytic Action on Cable Sheaths, etc.
10. Constants of Conductors used for Telegraph and Telephone Purposes.

GROUP I.

1. Submarine Cables.

GROUP K.

1. Electric Lighting.
2. Lifts.
3. Heating Systems.
4. Pneumatic Tube Systems.
5. Gas and Petrol Engines.