

AUTOMATIC SYSTEM EXTENSION PLAN I ON PMBX'S WITH 'C' WIRE SIGNALLING USING TELEPHONES No.740, 746 AND 746R

N4641
PAGE I-5
ISSUE B

NOTES

- The facilities of Plan 1 are shown on Diagram N1424.
- APPARATUS REQUIRED:-

MAIN:-

EXTN:-

WITH THREE EXTENSIONS

- (a) Part 2/DST/836
- (b) Switch No. 19B-1
- (c) Block Terminal No. 36B
- (d) Cord Inst. No. 12/15 AD
- (e) Telephone No. 740
- (f) 1 Each Part 5/, 6/, 7/ and 8/DBU/372
- (g) 4 Parts 1/DPI/203
- (h) 4 Switches No. 5A-4

- (a) Telephone No. 746R
- (b) Switch No. 19B-1
- (c) Bell No. 56A
- (d) Block Terminal No. 36B
- (e) Cord Inst. No. 9/21 AD(First & Intermediate)
- (f) Cord Inst. No. 6/61 AT (Last)

WITH TWO EXTENSIONS

- Items (a) to (e) above plus:-
- 1 Each Part 5/, 6/ and 8/DBU/372
 - 3 Parts 1/DPI/203
 - 3 Switches No. 5A-4

Items (a) to (f) above.

WITH ONE EXTENSION

- Items (a) to (c) above plus:-
- Cord Inst. No. 9/21 AD
 - Telephone No. 746
 - 1 Each Part 5/and 7/DBU/363
 - 2 Parts 1/DPI/203
 - 2 Parts 1/DPL/1022
 - 2 Switches No. 5A-4

Items (a) to (d) and (f).

- See Dgm N4700 for 'add-on' items when alternative telephones are used.
- The line, C wire and earth may be connected at an extension if more convenient.

MAIN

- Using Telephone No. 740 provide Cord Inst. No. 12/15 AD, Block Terminal No. 36B Switch No. 19B-1 and Part 2/DST/836. Fit Switch No. 5A-4 and Part 8/DBU/372 in Position D. Fit Switches No. 5A-4 and Parts .../DBU/372 for each extension in positions A to C in order. Adjust Latches A to D to setting 3, X and Y Latches to setting 5 (see Dgm N848).

Using Telephone No. 746 recover Cord Inst. No. 4/121 AT and Block Terminal No. 52A. Provide Cord Inst. No. 9/21 AD, Block Terminal No. 36B, Switch No. 19B-1 and Part 2/DST/836. Fit Switch No. 5A-4 and Part 5/DBU/363 in position B, Switch No. 5A-4 and Part 7/DBU/363 in position C. Rearrange straps and connect as shown.

- When an extension bell is required connect in place of strap between terminals BT2 and BT8 in Block Terminal No. 36B.

EXTENSION

- Recover Cord Inst. No. 4/121 AT and Block Terminal No. 52A from Telephone 746R and provide appropriate Cord Inst. and Block Terminal No. 36B. Fit Switch No. 19B-1 and shift leads of Recall switch No. 5A-4 as follows:- Blue from T15 to T11, Brown and Slate leads from T8 and T9 to T14. Rearrange straps and connect as shown.

- The coils of the Bell No. 56A should be connected in series.

CABLING:-

- TWO EXTNS.

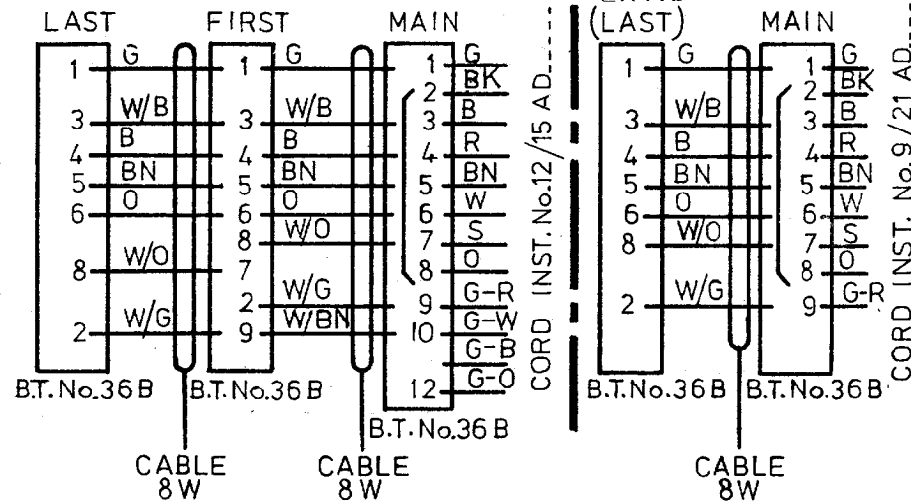

B	New Format. Teles Changed. Notes Rewritten. Minor Amendments.		D.I.F. 107.1.1
			24.7.75

EXPLANATORY

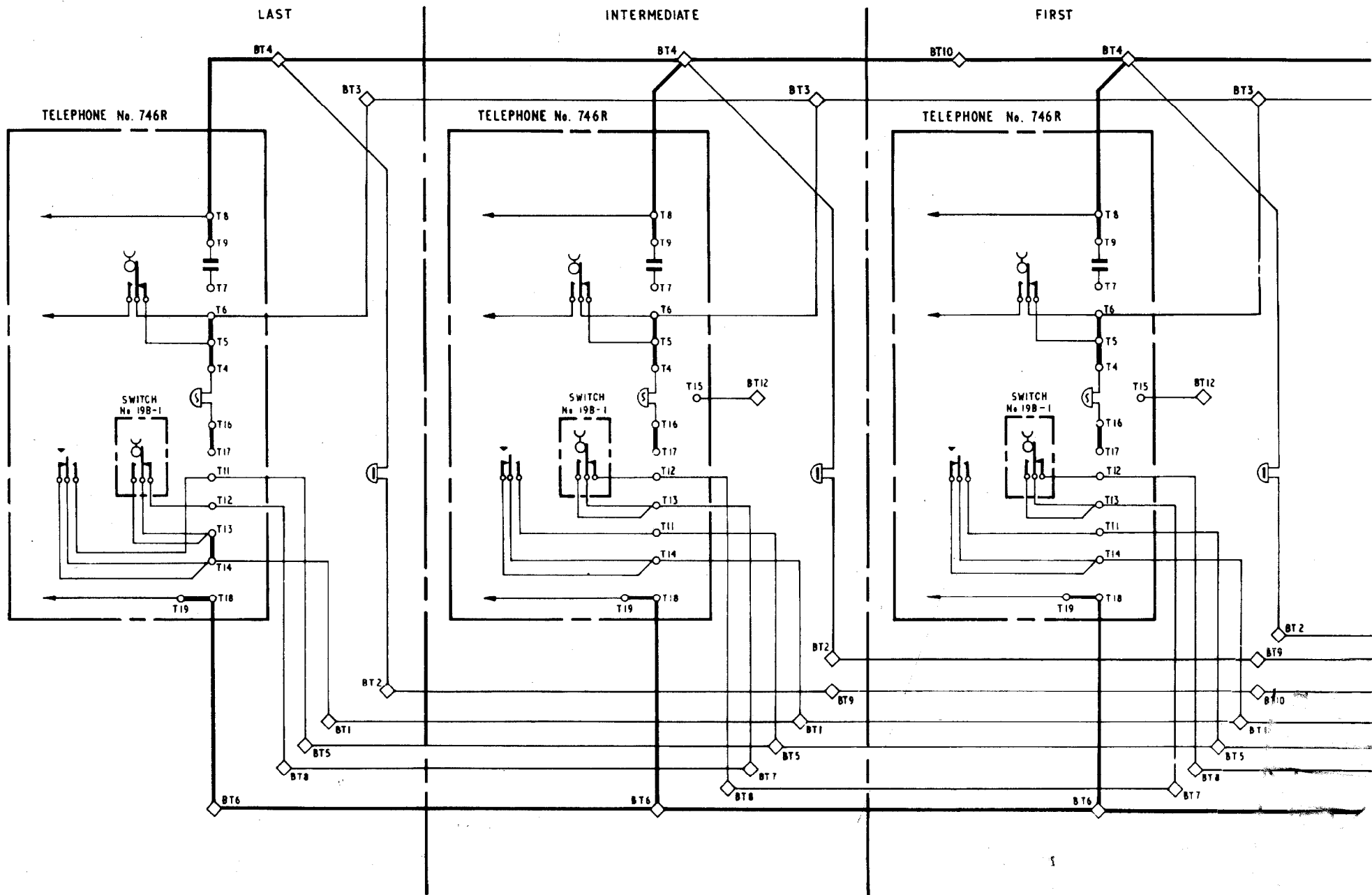

EXPLANATORY
WITH THREE EXTENSIONS
(SEE NOTES 9 & 10 FOR TWO OR ONE)

MAIN

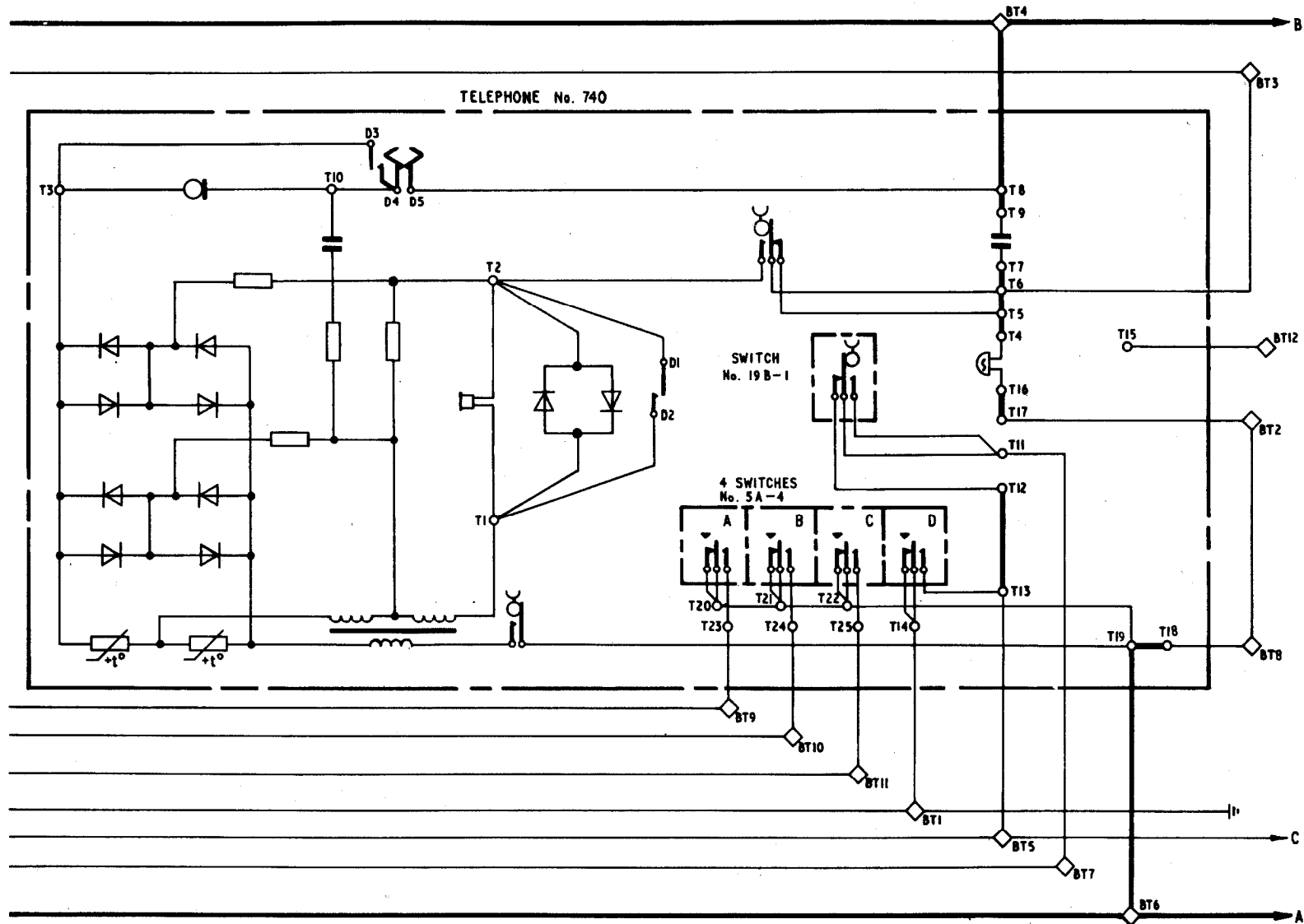

WIRING

LAST

TELEPHONE No. 746R... (NOTE 7)

BELL
No. 56A

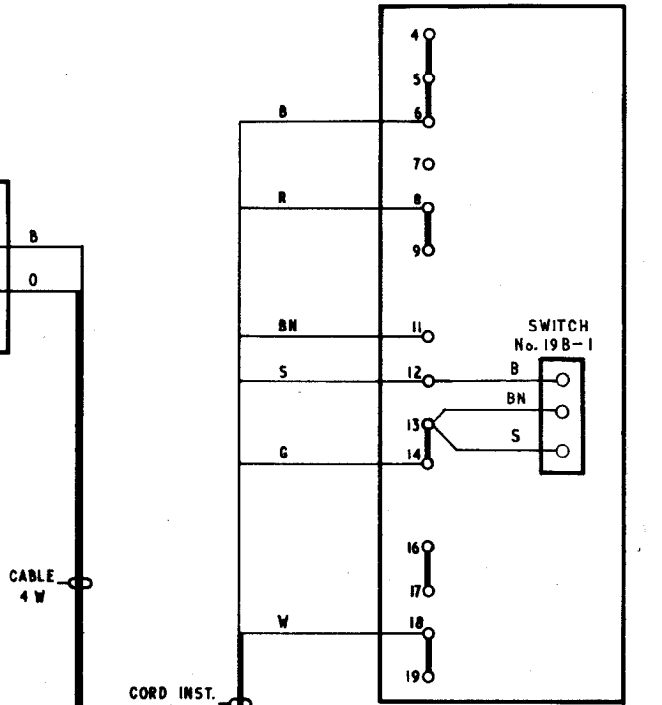
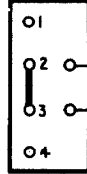

CORD INST.
No. 6/64AT...

CABLE
4 W

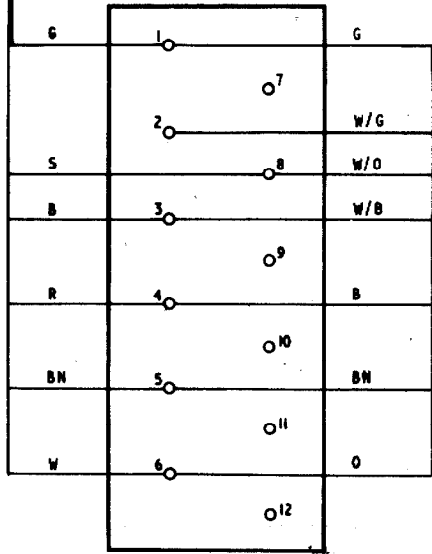

BLOCK TERMINAL No. 36 B

INTERMEDIATE

TELEPHONE No. 746R... (NOTE 7)

BELL
No. 56A

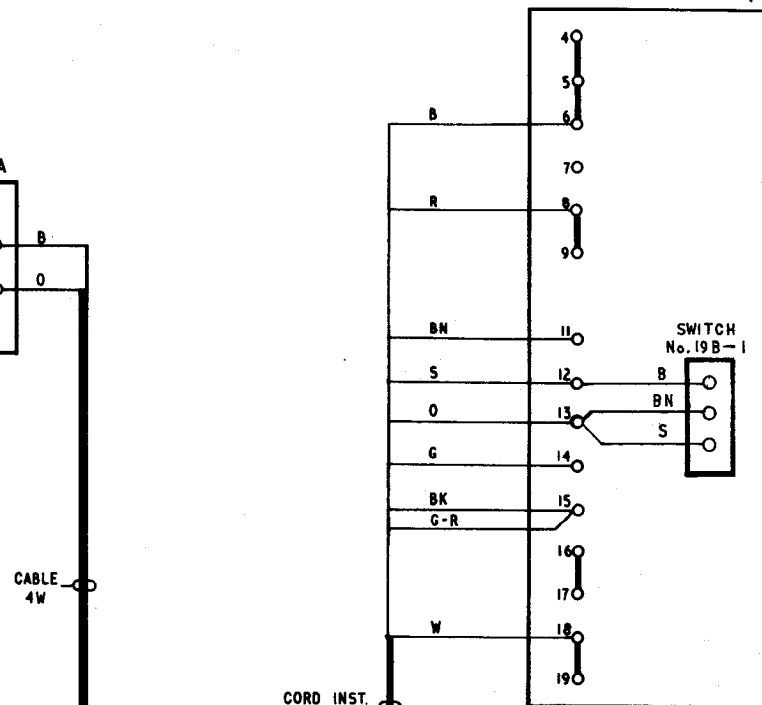
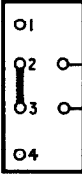

CORD INST.
No. 9/21AD...

CABLE
4 W

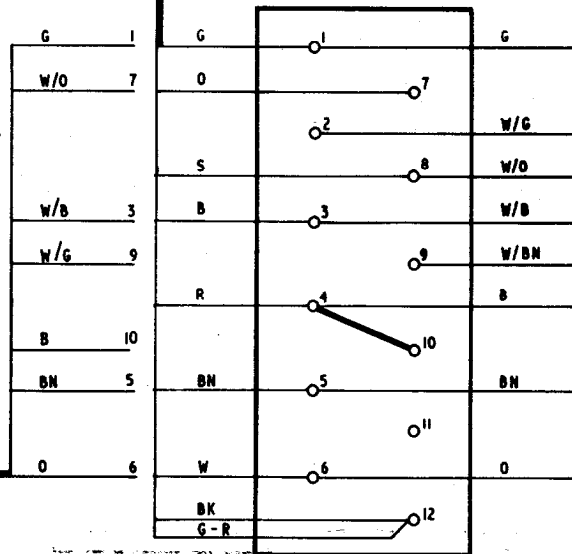

BLOCK TERMINAL No. 36 B

CABLE 8 W

WIRING
WITH THREE EXTENSIONS
(SEE NOTES 9 OR 10 FOR TWO OR ONE)

MAIN (NOTE 5)

TELEPHONE No. 740

FIRST

