

CB & AUTO SYSTEM
SUBSCRIBERS EXTENSION PLANS 7 & 7A ON STANDARD PABX's & PMBX's
WITH ENQUIRY, TRANSFER AND OPERATOR RECALL FACILITIES

N4357
PAGE 1-4
ISSUE C

NOTES

1. The facilities given by Plans 7 & 7A are shown on Dgm. N1429.
2. APPARATUS REQUIRED

MAIN

- 1 Telephone No. 24B... minus base
- 1 Bell-set No. 44
- 1 Bell No. 59A or No. 64D
- 1 Box Battery No. 3
- 2 or 3 Cells Dry R40

EXTENSION

- 1 Block Terminal No. 36B
- 1 Bell No. 56A
- 1 Key No. 304A
- 1 Label No. 252T and

EITHER

- 1 Telephone No. 328... minus cord
- 2 Plungers 1/SPL/325
- 1 Cord Inst. 5/14B

OR

- 1 Telephone No. 321...
- 2 Plungers 1/DPL/361

MAIN

3. Connect extension bell in place of strap between BT1 & BT2. When trembler bell required in addition to buzzer connect between BT7 & BT10.
4. In Bell-set 44 remove Strap 19-20. Transfer green-red conductor from 4 to 6. Insert Strap 4-5.
5. The diagram shows the connexions for Plan 7. For Plan 7A in Bell-set 44 remove Straps 1-2, 3-4, 31-32 and 34-35. Connect Straps 32-33 & 35-36.

EXTENSION



6. Set Latch Bracket Control Plate of the Key No. 304A as shown on Dgm. N4301 Fig. 1.

LECOMMS RS. LOUR:- Y STN. & AUTO	ISSUE			
		C	NEW FORMAT. MINOR AMENDMENTS. MADE YELLOW. <i>ML</i> TD2.3.1	14 . 5 . 74
		B	WIRING CORRECTED ON EXTN TELE. NO. 321	23.10.59

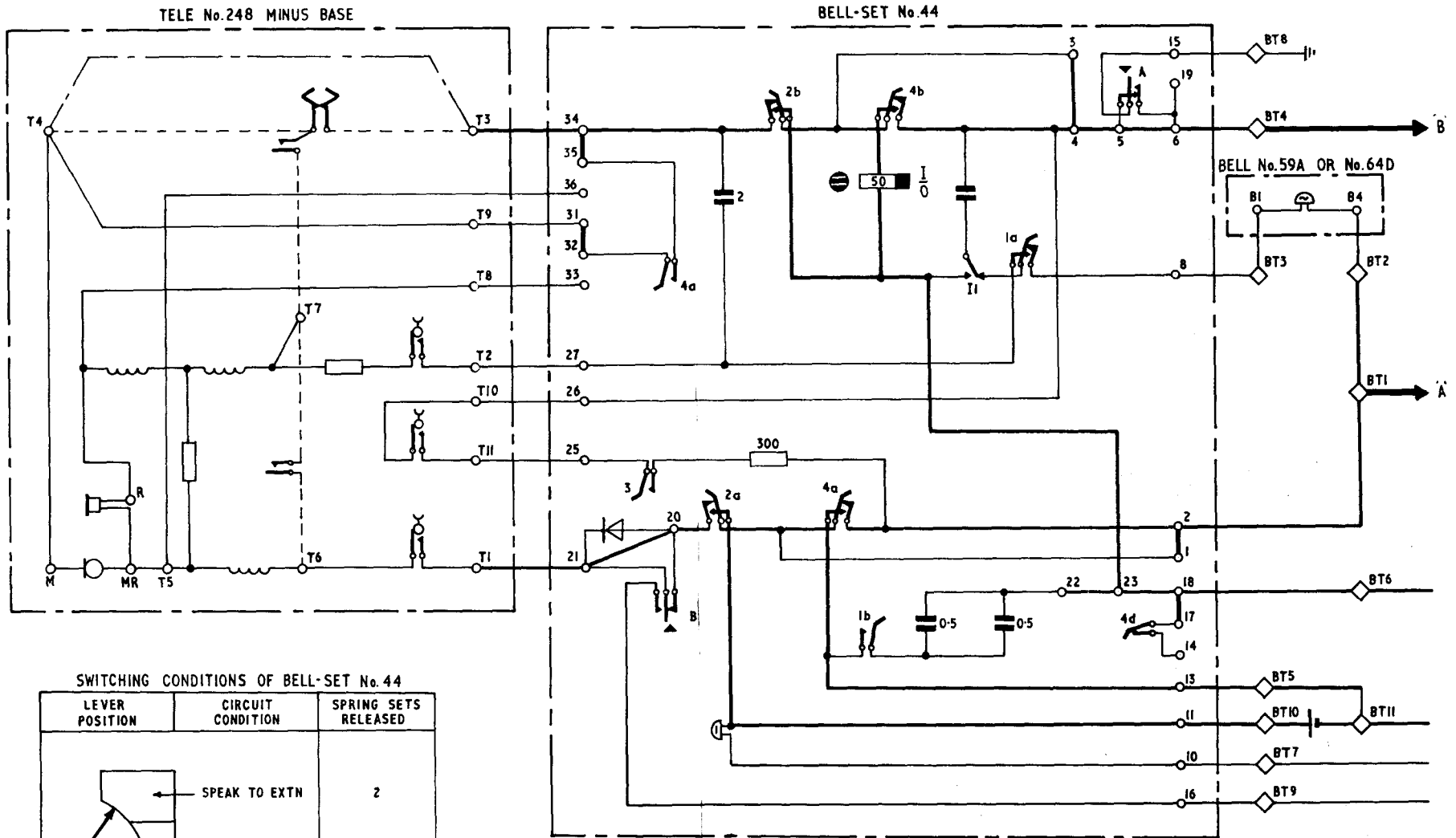
EXPLANATORY OF MAIN

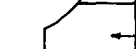

SWITCHING CONDITIONS OF BELL-SET No. 44

LEVER POSITION	CIRCUIT CONDITION	SPRING SETS RELEASED
	SPEAK TO EXTN	2
	SPEAK TO EXCH	1
	SPEAK TO EXTN EXCH HELD	2 & 3
	EXTN TO EXCH	4

EXPLANATORY OF EXTENSION

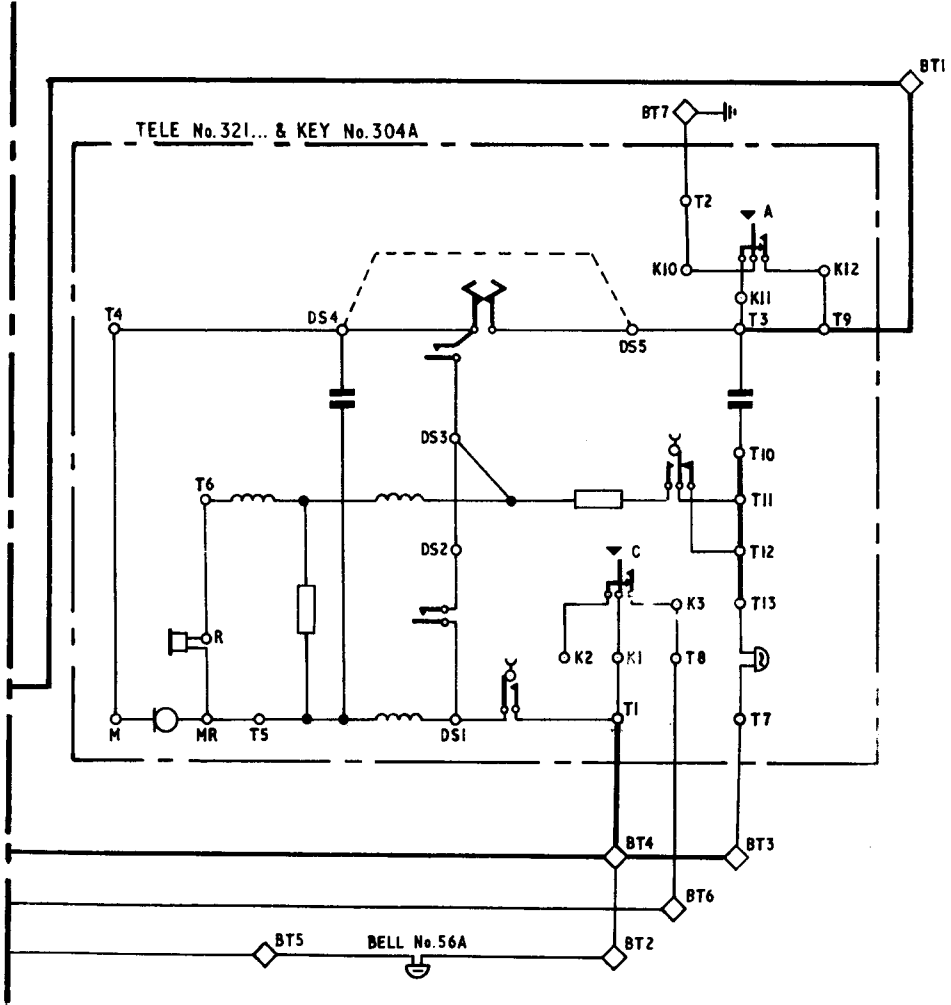
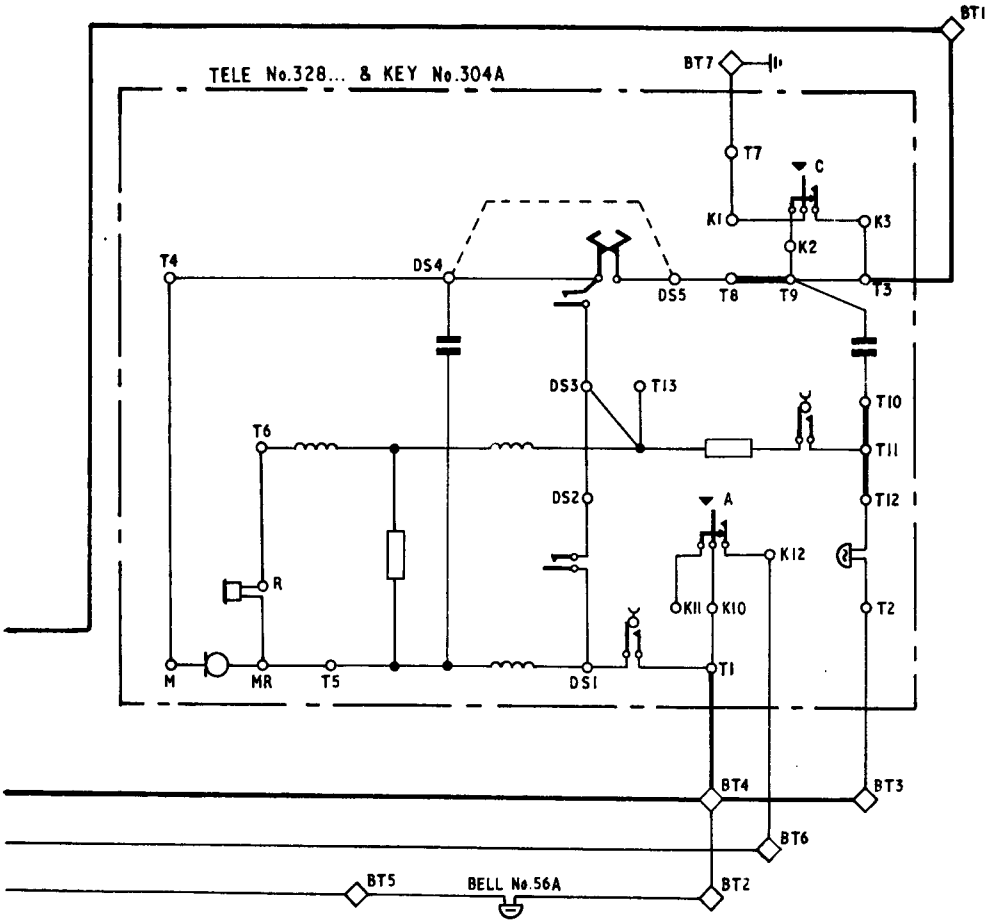

WIRING

EXTENSION

MAIN

