

CIRCULATION

GENERAL

DIAL AUTO. No. 11...
**DIAGRAM SHOWING SPRINGSET CONNEXIONS
AND NUMBER PLATE LABELS.**

N 611
2 PANELS - 1

15-9-39

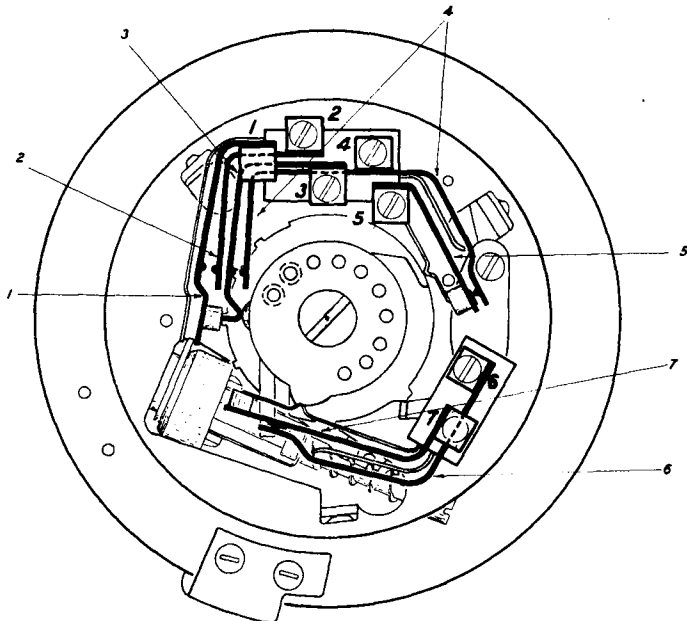
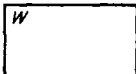
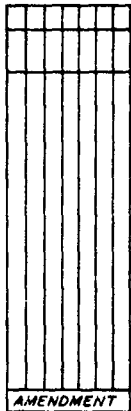

REAR VIEW SHOWING SPRING CONNEXIONS.



SCHEMATIC CONVENTION.

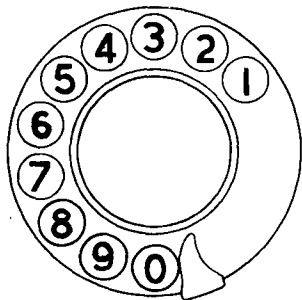

FA & FS WITH NUMBER PLATE LABEL No. 149.

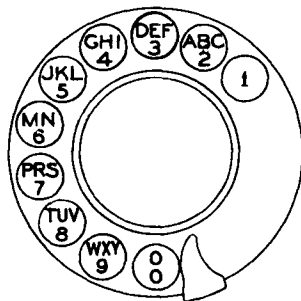

LA WITH NUMBER PLATE LABEL No. 150.

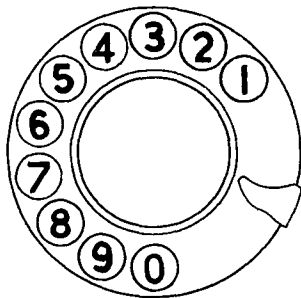

FW WITH NUMBER PLATE LABEL No. 149.

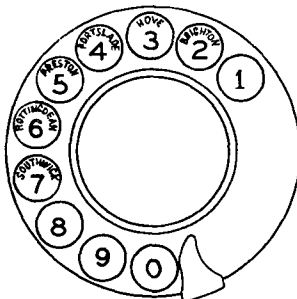

BA WITH NUMBER PLATE LABEL No. 155.