

THE POST OFFICE ELECTRICAL ENGINEERS' JOURNAL

Vol. 48

JANUARY 1956

Part 4

CONTENTS

	PAGE
THE NEW INDEPENDENT-TELEVISION NETWORK—S. H. Granger, A.M.I.E.E.	191
ACCELERATED LIFE TESTS IN THE INVESTIGATION OF MECHANICAL PERFORMANCE—M. Mitchell, M.B.E., E.R.D., B.Sc.(Eng.), A.M.I.E.E., and E. W. C. Hubbard	198
A NEW CABLE-DRUM TRAILER—J. J. Moffatt, A.M.I.Mech.E., A.M.I.E.E.	202
MODERNISATION OF RADIO AND RADAR EQUIPMENT IN H.M. TELEGRAPH SHIPS—W. Dolman, M.Eng., and P. W. J. Gammon	204
SOME PRINCIPLES OF ANTI-SIDE-TONE TELEPHONE CIRCUITS—H. J. C. Spencer, A.M.I.E.E.	208
“MOSAIC”—AN ELECTRONIC DIGITAL COMPUTER, Part 3(a)—The Art of Programming—A. W. M. Coombs, Ph.D., B.Sc., A.R.T.C.	212
CARRIER FREQUENCY GENERATING EQUIPMENT FOR LARGE COAXIAL AND CARRIER STATIONS, Part 2—The 124 kc/s Master Oscillator, the Frequency Dividers and the Frequency-Comparison and Alarm Apparatus—E. T. C. Harris, B.Sc.(Eng.), A.M.I.E.E., and S. Mundy	216
THE LABORATORY PRODUCTION OF LARGE WATER-SOLUBLE CRYSTALS—E. A. Taylor	219
THE DOVER-DEAL EXPERIMENTAL CABLE, Part 1—Description of Cable, Factory Tests, Installation and Jointing—H. C. S. Hayes, M.I.E.E.	224
THE BRITISH POST OFFICE SPEAKING CLOCK, MARK II, Part 2—Layout, Manufacture and Testing of Equipment, and Packing for Export—R. L. Smith	229
THE PROVISION OF CIRCUITS FOR TELEVISION OUTSIDE BROADCASTS, Part 2—Injection of Vision Signals at Intermediate Points on Main Cable Links—M. B. Williams, B.Sc.(Eng.), A.M.I.E.E., and J. B. Sewter, A.M.I.E.E.	234
COMPLETION OF THE FIRST TRANSATLANTIC TELEPHONE CABLE	239
A METHOD OF RECORDING CONTACT RESISTANCE UNDER DYNAMIC CONDITIONS—T. F. A. Urben, B.Sc.(Eng.), A.M.I.E.E., and S. H. Sheppard	240
INSTITUTION OF POST OFFICE ELECTRICAL ENGINEERS	246
NOTES AND COMMENTS	247
REGIONAL NOTES	249
ASSOCIATE SECTION NOTES	254
STAFF CHANGES	256
INDEX TO VOLUME 48	258
BOOK REVIEWS.	211, 228, 238, 239, 245

Price 2/6 net

THE INSTITUTION OF POST OFFICE ELECTRICAL ENGINEERS

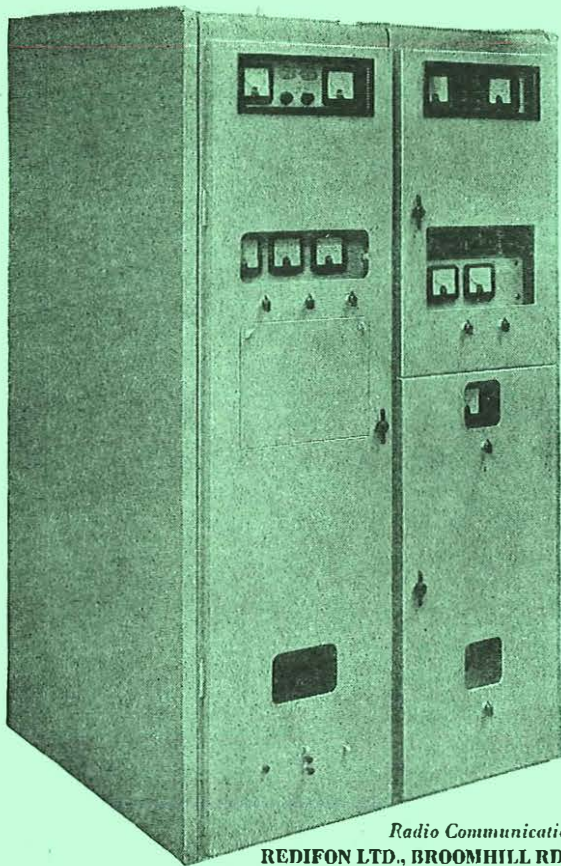

10

SPOT FREQUENCIES

THE ANSWER TO INCREASING
TRAFFIC DENSITIES

The Redifon G.143 TRANSMITTER for medium distance links meets the need for rapid frequency changing where high traffic density conditions prevail at shore stations, and for conserving engineering staffs at all but the largest centres. It provides ten stabilised crystal controlled frequencies for telegraphy or telephony in the 2.26 Mc/s band and has a power output of 1 kW. Only one pair of lines is required for complete remote control up to 25 miles.

Redifon G.143 TRANSMITTER

Radio Communications Division

REDIFON LTD., BROOMHILL RD., LONDON, S.W.18 VAN 7281 A Manufacturing Company in the Rediffusion Group

PITMAN TECHNICAL BOOKS

TELEPHONY

By J. Atkinson, A.M.I.E.E., Executive Engineer, Post Office Engineering Department. This massive two-volume treatise is recognised as the standard work on the subject. Volume I is primarily devoted to the signalling and switching of the manual exchange systems. Volume II deals with the complete range of modern automatic switching and gives a detailed treatment of the various circuits and accessory equipment employed.

Volume I. "General Principles and Manual Exchange Systems." 40/- net

Volume II. "Automatic Exchange Systems." 55/- net

TELECOMMUNICATIONS PRINCIPLES

By R. N. Renton, A.M.I.E.E. A useful work covering the syllabus for the City and Guilds examinations in Telecommunications Principles, Grades I, II and III. Illustrated. 37/6 net

"Can be confidently recommended to all students of Telecommunications."—*Post Office Telecommunications Journal*

TELECOMMUNICATIONS

By A. T. Starr, M.A., Ph.D., M.I.E.E. This book, a new addition to the Pitman Engineering Degree Series, has been written to cover the syllabus for the subject of Telecommunications in the London University Degree, but the choice of materials should make the book very acceptable to all who are studying the subject. It will provide the student of "light" electrical engineering with a firm foundation for specialisation and advanced study. Illustrated. 35/- net

SIR ISAAC PITMAN
& SONS LTD.

Parker Street, Kingsway,
London, W.C.2.

VALUABLE FREE BOOK

Tells You How to Pass Your C. & G. or
Promotion Exam. at First Attempt!



All Post Office Engineering personnel who are anxious to obtain early promotion should at once send for a copy of our handbook "ENGINEERING OPPORTUNITIES," which among other intensely interesting matter describes our unique methods of preparation for TECHNICAL APPOINTMENTS IN THE POST OFFICE (Assistant Engineer—New Style and Assistant Traffic Superintendent), CITY AND GUILDS EXAMINATIONS in Principles of Telecommunications (1-5), Radio (1-4), Telephone Exchange Systems (1-3), Telegraphy (1), Line Transmission (1 and 2), Lines Plant Practice (1 and 2), Mathematics for Telecommunications (1-5), Electrical Engineering Practice (Prelim. Inter. and Final), and outlines a wide range of non-examination courses in all branches of Electrical, Mechanical, Civil, Automobile, Aeronautical and Radio Engineering.

Assistant Engineer and Assistant Traffic Superintendent. Open competitions now resumed. Age extensions for established Civil Servants. Ask us for full details

We definitely guarantee
"NO PASS—NO FEE"

If you intend to make the most of to-day's opportunities, you cannot afford to miss reading "ENGINEERING OPPORTUNITIES." It tells you everything you want to know to secure advancement, and describes many opportunities you may now be missing through lack of information. Send for your copy to-day—FREE and without obligation.

BRITISH INSTITUTE
OF ENGINEERING TECHNOLOGY
369 COLLEGE HOUSE,
29-31 WRIGHT'S LANE, LONDON, W.8

BIET

THE POST OFFICE

ELECTRICAL ENGINEERS' JOURNAL

Vol. 48

January 1956

Part 4

The New Independent-Television Network

S. H. GRANGER, A.M.I.E.E.†

U.D.C. 621.397.743

The network planned to meet the needs of the new independent-television service which opened in London on 22nd September, 1955, is described and the basic structure of the network is outlined. A description of the London studio links and the inter-city network is then given, followed by performance targets and specimen test results.

INTRODUCTION

THE Independent Television Authority (I.T.A.) did not come into existence until 4th August, 1954, but the Government's intention to introduce a competitive television service was made known as early as May, 1952, when a White Paper was published announcing "an element of competition in the expanding field of television."¹ Preliminary inquiries revealed that only a limited number of frequencies in the V.H.F. Band 3 could be made available for the new broadcast stations, and that the service was therefore likely to develop on similar lines to that of the B.B.C., with high-power regional stations, and not on the American principle of small privately-owned independent stations. Hence the need was foreseen for a second inter-city network connecting London and the principal centres of interest in the provinces with the broadcast transmitters. Tentative plans were therefore drawn up during 1953 to exploit all spare plant to the full and, if necessary, to adapt existing circuits should the new service be required during 1954.

Several problems could not be resolved until after the I.T.A. had become firmly established; one of the most important being that of obtaining details of the studio sites and scale of circuit provision required in the London area. This was further complicated by the fact that the I.T.A. would not itself be responsible for producing the programmes and was therefore only able to provide the Post Office with information about the requirements for the main inter-city network and the shorter circuits to transmitter sites, i.e., the "transmitter tails." Production of the programmes from each transmitter became the responsibility of two programme contractors selected by the I.T.A.; one being allotted the Monday-to-Friday programmes and the other the week-end programmes. Thus it became clear that two more or less independent studio networks might be required in the area served by each transmitter, particularly in the London area, but the precise circuit arrangements could not be determined until the programme contractors were able to state their definite requirements. In some cases this meant waiting until suitable property had been acquired for use as studios and master control centres; but, eventually, the pattern of studio-circuit provision became clear, although orders for several of the many important circuits were received as late as May, 1955. Nevertheless, through the enthusiastic co-operation of the installation, maintenance and outside-broadcast staffs, all of these circuits were provided, some in their permanent form and others using temporary equipment, in time for the opening of the new service in London on 22nd September, 1955.

BASIC PLAN OF THE NEW NETWORK

When planning the first television network for the B.B.C. it was considered that repeated modulations and demodulations of the video signal should be avoided as far as possible, as any such process must introduce some degree, however slight, of non-linear distortion, which cannot be removed by the normal equaliser and corrector networks designed around linear elements. The ideal network, it was argued, should employ a common mode of transmission and at junction points the inter-connections should be made by using equipment operating in this mode. For example, in a coaxial-cable carrier system all inter-connections would be made at carrier frequency, the video signal being recovered only at monitor points, in parallel with the main transmission path, and at the ends of transmitter tails. The equivalent concept in a point-to-point radio transmission system would be to operate the junction points at the radio intermediate frequency. An approach to the principle of through-carrier switching was made at Manchester on the Birmingham-Manchester coaxial-cable circuit and later at London on a similar coaxial-cable circuit to Wenvoe. However, the complete application of this principle proved too restrictive because it would have prevented development of transmission systems of slightly different, and of more satisfactory, characteristics. It was also found that this principle could not be applied in practice because the London-Scotland link consisted of two entirely different coaxial-cable systems in tandem with a super-high-frequency radio link which required a video input signal.

The abandonment of through-carrier working, and the introduction of centres for the switching of links at video frequency, was made practical by the development of a satisfactory video waveform corrector² known as an "echo-type" corrector, which reduces to very small magnitude the linear distortion of video waveforms on long-distance point-to-point links. This corrector consists primarily of a tapped delay line along which the video signal passes and from which echoes of controlled magnitude and sense can be obtained and added to the video signal in such a manner as to modify and correct the waveform. It is essentially a linear network and therefore cannot correct non-linear distortion due to repeated modulations and demodulations. However, careful measurement and study have shown that, if the number of point-to-point links in tandem does not exceed four, and if the linear distortion is accurately corrected at the receive end of each point-to-point link, the cumulative non-linear effects are tolerable because they do

† Temporary Senior Executive Engineer, Transmission and Main Lines Branch, E.-in-C.'s Office.

¹ For references see end of article.

not last long enough to cause appreciable impairment of the received picture.

The case for recovering the video signal at the receive end of each point-to-point link was established even more firmly when it became evident that the new network required by the I.T.A. would be more complex, and would need to be more flexible, than that previously provided for the B.B.C. The many short links serving studios in London might require inter-connection one with another, and with the main network, on frequent occasions and at short notice. Also, the main network serving the master control of any one programme company on week-days would need to be switched to that of some other programme company at week-ends. Such flexibility could be obtained only by the introduction of the equivalent of the telephone exchange distribution frame, i.e., all vision circuits, adjusted to a specified level and impedance, should be arranged to terminate on video distribution racks.

The work of extending the circuits, if required, to any Network Controller is simplified by concentrating, within the control repeater station, the inputs and outputs of all television circuits, at uniform level and impedance. It will also facilitate the addition of remote or automatic switching at a later stage.

Additional support for the decision to introduce the video distribution racks at control repeater stations came with the development, by the Post Office Research Station, of simple video equipment for the provision of short tie circuits on coaxial cable to the programme companies' studios and master control centres. The short tie circuits proved to be practically distortionless; and it became possible to reduce maintenance costs on many circuits by installing all active transmission equipment, irrespective of the transmission directions, at the controlling repeater stations. Similar equipment for balanced-pair cable is also being developed.

The main inter-city network, the local studio networks, and the short links to transmitters are focused on the control repeater stations, which, ideally, are situated near the centre of television interest and activity. This is generally towards the centre of the city in which a link terminates, e.g., Museum Exchange for London, and Telephone House for Birmingham. The operation of switching and re-routing circuits in accordance with the wishes of the programme companies is carried out at these stations, which are now known as "Network Switching Centres" (N.S.C.).

Music circuits which have to be switched with their associated vision circuits are also concentrated at the network switching centres and are arranged to appear on a programme frame at specified standard level and impedance. Audio control circuits, being much cheaper, have been provided in sufficient quantity to make switching unnecessary.

Programme Switching Centres.

The key point in the vision circuit network of any programme company is its Master Control or Programme Switching Centre (P.S.C.). Here the outputs from several studios, outside broadcast circuits, or "tele-cine" equipments are selected as required to form the finished programme, which is then connected to a circuit to the N.S.C. for connection to the local transmitter tail or to the main network. The switching carried out at the P.S.C., including mixing, fading, and changing from one programme service to another without a gap in the transmitted programme, is known as "continuity switching;" a form of switching which, in normal circumstances, is outside the responsibility of the N.S.C. To enable the programme company to have complete control over all the programme services at its command, together with adequate pre-view facilities,

a considerable number of vision circuits are needed between the N.S.C. and the P.S.C. It is therefore preferable that the programme company should locate its P.S.C. within a reasonably short distance of the N.S.C. so that a simple and relatively inexpensive mode of transmission without intermediate stations can be used on the vision circuits. Direct transmission of the video waveform is used; the circuits being fully corrected and adjusted to a gain of unity. Two forms of short tie circuit are available and both have been used in the London network.

Signal Levels at Switching Points.

At the N.S.C. and P.S.C. the vision signals appear at a standard switching level of 1 volt peak-to-peak across an impedance of 75 ohms unbalanced to earth, the level being defined as the voltage difference between that part of the waveform corresponding to picture white and that corresponding to the tips of the synchronising pulses.

Similarly, permanent music circuits are switched at a standard level of 1 mW, the switching impedance being 600 ohms balanced to earth; the switching level is defined as that of a test signal of sinusoidal waveform at a nominal frequency of 800 c/s. The circuits are fully equalised and adjusted to zero loss.

Coaxial-Cable Video Transmission.

The first form of short video tie circuit operates over coaxial cable; typical examples in the London network are the circuits on the $\frac{1}{4}$ -mile route between Museum and Britalian House, Foley Street. The low loss of coaxial cable, 7 db. per mile at 3 Mc/s for $\frac{3}{8}$ -in. coaxial pairs, makes it possible to operate circuits not exceeding 1 mile in length with the amplifiers at the sending end, i.e., the signal is pre-amplified and the transmitted level is such that the signal arrives at the receiving end of the circuit at the standard level of 1 volt peak-to-peak. Thus, although circuits operating in either direction may be provided between the N.S.C. and the P.S.C., the active amplifier equipment need be installed only at the N.S.C. where it will be under the continuous supervision of Post Office maintenance staff during programme hours. Passive waveform-corrector networks are associated with the amplifiers on such circuits, pre-correction being applied to the outgoing circuits and post-correction to the incoming circuits at the N.S.C. The circuit arrangement is outlined in Fig. 1 (a).

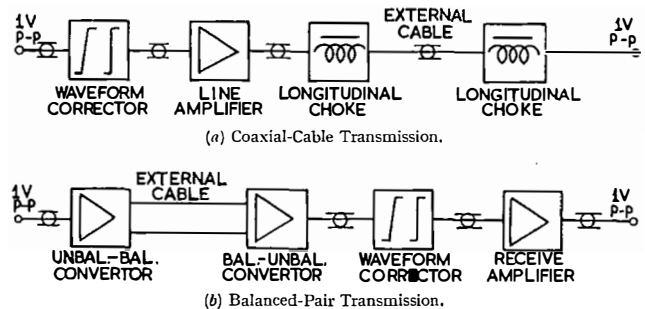

FIG. 1.—BLOCK SCHEMATIC DIAGRAMS OF VIDEO TIE CIRCUITS.

Owing to the rapid deterioration in the shielding effect of the coaxial outer conductor as the frequency falls below about 10 kc/s, it is necessary to adopt certain precautions to prevent low-frequency interference when the coaxial pair is used for direct video transmission. At the very low frequencies, particularly 50 c/s, the penetration of the outer conductor by longitudinal currents is complete and a transverse interfering current appears in the main transmission path due to the common coupling impedance of the outer conductor. The circuit for the longitudinal

current is completed through the equipment earth at each end. Hence, elimination of the interfering signal by simply breaking the earth continuity would appear possible; but, unfortunately, no suitable transformer capable of passing the video waveform without severe distortion is yet available. In practice, the longitudinal current is considerably reduced by adding a longitudinal inductance, or coaxial choke, at each end of the circuit. Correct choice of core material for any choke of this type is essential. A high value of incremental permeability is required; firstly, to enable the inductance to be obtained within a reasonable bulk and, secondly, because the longitudinal current may contain a large D.C. component of magnitude up to 50 mA. The present design of coaxial choke has a longitudinal inductance of 0.3 henry at 50 c/s and consists of a polythene-insulated coaxial cable of small diameter wound on a core of radiometal laminations. Saturation of the core due to the D.C. component is prevented by including an air gap which is obtained by butting instead of interleaving the laminations. Fig. 2 shows four

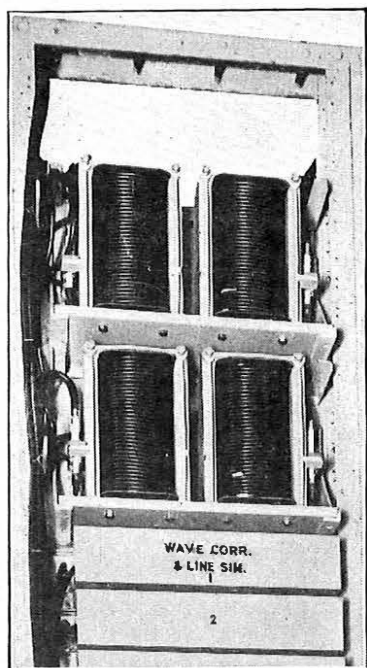

FIG. 2.—RACK-MOUNTED COAXIAL CHOKES.

coaxial chokes mounted within a standard repeater-station rack framework. A single coaxial choke weighs 45 lb. and the winding consists of approximately 90 yd. of coaxial cable. The nature of the waveform distortion due to the chokes is broadly equivalent to that introduced by an extension of the circuit length and is corrected in the tie-circuit waveform corrector. The insertion of coaxial chokes in circuits of about one mile in length results in the suppression of 50 c/s hum and its harmonics by about 30 db. As an additional precaution against impulsive interference, unbalanced audio circuits, including those momentarily unbalanced during signalling, are routed in separate cables. Normally the interstice pairs of the coaxial cable are reserved for balanced music circuits.

Balanced-Pair Video Transmission.

For the second form of short video tie circuit the line signal is balanced to earth and the connection between the switching centres is made by a television cable of new type containing screened balanced pairs. The cable shown in Fig. 3 is similar to the one laid in London between Museum and Television House, Kingsway—a distance of

approximately $1\frac{1}{2}$ miles. It contains six screened balanced pairs, seven pairs of 20-lb. copper conductor, in twin formation, and 12 pairs of 10-lb. copper conductor made up as six quads. Each screened television pair consists of two 40-lb. copper conductors located by means of spiral lappings of polythene string within a cylindrical copper screen. In a later design of this cable additional mechanical stability has been obtained by replacing the polythene string with an insulant of expanded polythene, which is more robust. At 3 Mc/s, the nominal maximum video frequency transmitted on British circuits, the screened balanced pair has a loss of 13.7 db. per mile at 10°C and the loss/frequency characteristic follows approximately the law:—

$$7.7\sqrt{f} + 0.3 \text{ db. per mile, where } f = \text{frequency in Mc/s.}$$

Each pair equipped for television will employ balanced-pair line equipment of new design. This will include an unbalanced-balanced unit capable of accepting the signal from the switching point at the standard level of 1 volt peak-to-peak in 75 ohms unbalanced to earth and converting it to a balanced output signal. At the receiving end the signal will be restored to the unbalanced form and applied to a passive waveform corrector network followed by an unbalanced receive amplifier. The circuit is shown in outline in Fig. 1 (b).

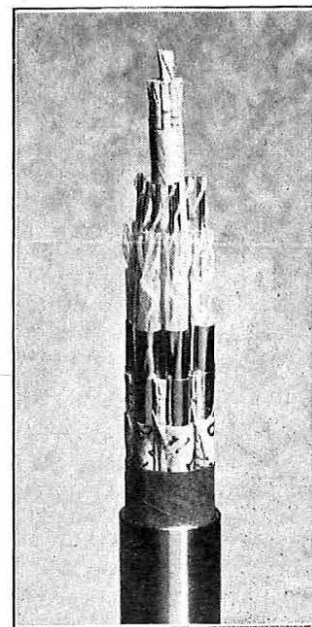

FIG. 3.—BALANCED-PAIR TELEVISION CABLE.

MISCELLANEOUS EQUIPMENT AT SWITCHING CENTRES

Two main video flexibility points are provided at the N.S.C., the first at the video distribution rack for all vision circuits and the second at the monitor distribution rack for all picture monitor circuits. Network switching in accordance with schedules supplied by the programme companies is carried out at the video distribution rack. Those circuits

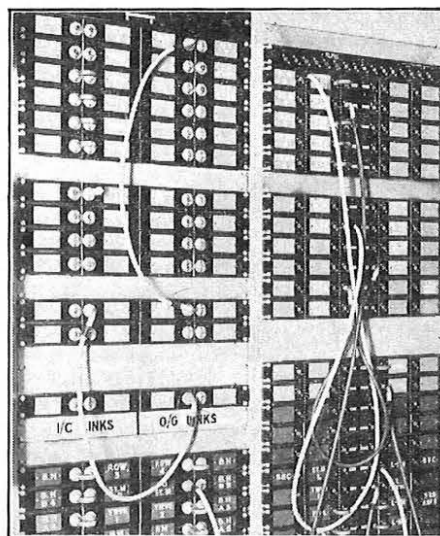

FIG. 4.—VIDEO DISTRIBUTION RACKS AT MUSEUM EXCHANGE.

which require frequent inter-connection are arranged to appear at adjacent points so that the connection can be made via a coaxial U-link, other circuits being inter-connected by means of coaxial cords made from polythene-insulated coaxial cable fitted with clamped end-sockets. The complete flexibility provided at the monitor distribution rack between the suite of picture monitors and all the vision-circuit monitor points is especially useful when a change of routing of the network is required. A section of the monitor suite can be connected to the monitor points on the required new routing so that when the change has been made the correctness of the new arrangement is instantly displayed. Fig. 4 shows a section of the distribution racks at Museum Exchange, London.

The central observation suite of picture monitors consists of a number of 7-ft. 6-in. racks, on each of which are assembled four picture monitors. These monitors are designed to accept the video waveform at the standard level of 1 volt peak-to-peak across 75 ohms unbalanced to earth, and all vision-circuit monitor outlets are arranged, if necessary by the inclusion of permanently-connected amplifiers, to provide that level at the monitor distribution rack. The relatively-simple picture monitors reproduce the picture on a 9-in. cathode-ray tube using conventional circuit techniques. A diode D.C.-restorer circuit of long time-constant operating on the tips of the synchronising pulses ensures that hum and other low-frequency interference or long-period waveform distortion does not pass unnoticed.

An additional aid to tie-circuit supervision and maintenance is provided by "Programme On" indicators which are connected across the inputs and outputs of each circuit where the waveform is at the standard level. Essentially the indicator consists of a frequency-selective amplifier tuned to the fundamental-frequency component of the line-synchronising-pulse repetition rate, i.e. 10,125 c/s. The rectified output of the amplifier is arranged to control a sequence of relays which remain energised until the input level to the indicator falls 6 db. below the level of the line synchronising pulses when an all-black picture is being transmitted. The elements of the relay circuit shown in Fig. 5 illustrate the arrangements at the N.S.C. for display-

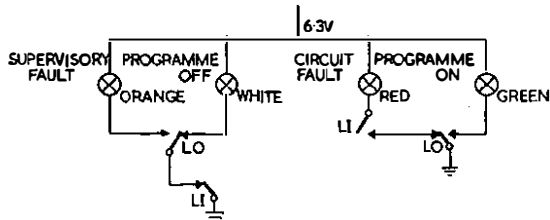

FIG. 5.—RELAY CIRCUIT OF "PROGRAMME ON" INDICATOR.

ing the condition of the vision circuit. Relays LI and LO are controlled by the input and output indicators respectively. Normally, both of these relays will be operated and a PROGRAMME ON indication will be given. Disconnection of the programme from the circuit by the programme company results in the simultaneous release of both relays thereby giving the PROGRAMME OFF indication. A CIRCUIT FAULT alarm is operated when LO releases with LI held; and, for the rare condition of LO held and LI released, a SUPERVISORY FAULT warning is given. The display unit at the N.S.C. is equipped with RECEIVING ATTENTION and RESET keys, the circuit of the latter being arranged to

connect an audible alarm at the instant the fault is cleared. This is a buzzer alarm as distinct from the CIRCUIT FAULT alarm which operates the station alarm bell. The provision of distinctive alarms enables the "lost programme time" of the vision circuit to be precisely defined and logged; a very important matter in the maintenance of any television service.

THE LONDON NETWORK

The London Television Control Centre at Museum Exchange is the focal point and N.S.C. of the London network, shown in Fig. 6. Short video tie circuits connect

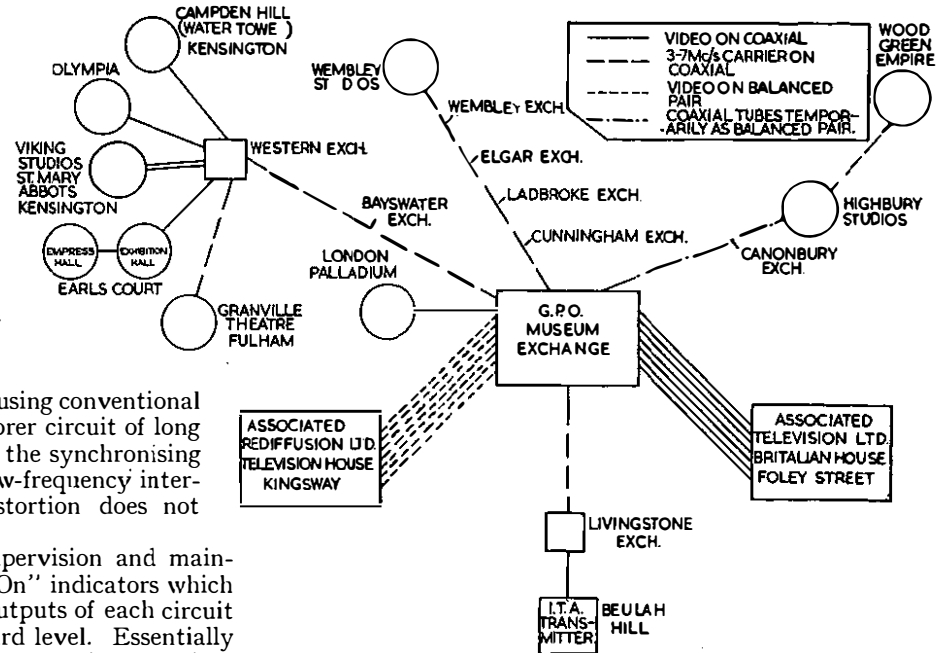

FIG. 6.—THE LONDON NETWORK.

Museum and the P.S.C. of Associated Rediffusion Ltd. at Television House and of Associated Television Ltd. at Britalian House. Links from the programme companies' studios are terminated at Museum; and, outgoing from Museum, is the transmitter tail to the site of the I.T.A. temporary London transmitter station at Beulah Hill, Croydon. Operation of most of the existing studio links, and of further links now planned, is in the 3-7 Mc/s carrier spectrum on 0.375-in. coaxial cable using equipment similar to that of the London-Birmingham 0.975-in. coaxial cable system.³ Exceptions are the links from the Palladium Theatre and Campden Hill Water Tower, which transmit an unbalanced video signal over coaxial cable.

The London network was required to open with the commencement of the new television service on 22nd September, 1955, but, to enable the programme contractors to rehearse their switching and programme building, the links were in fact made available some two to three weeks beforehand. In order to meet this date it was necessary initially to equip many of the links on a temporary basis, particularly those needing 3-7 Mc/s carrier equipment and balanced-pair line equipment. Fortunately the Post Office had already placed orders for the manufacture of Amplifiers No. 98A, the new design of balanced video repeater for outside broadcasts,⁴ which is equipped with variable equalisers for operation over different types of line. Extra quantities of the amplifiers were then ordered and were used throughout for the initial provision of the Museum-Television House tie circuits and for several of the

longer studio circuits. Studio links planned to work ultimately in the 3.7 Mc/s carrier spectrum were made to work initially as video-frequency balanced-pair circuits using the inner conductors of two 0.375-in. coaxial tubes. All the balanced video links operate without intermediate repeaters and, therefore, the Amplifiers No. 98A at the terminals are connected to give an output of 1 volt peak-to-peak across an impedance of 75 ohms unbalanced to earth. All 3.7 Mc/s carrier circuits provided by the opening date, namely those to Wembley Studios, Granville Theatre, Western Exchange, and Wood Green Empire, used temporary line equipment which is scheduled for early replacement.

The transmitter tail to Beulah Hill is a unidirectional circuit of approximately 9½ miles in length operating in the 3.7 Mc/s carrier spectrum and using one tube of a 3-tube 0.975-in. coaxial cable as far as Crystal Palace and then continuing as a single-tube 0.975-in. cable to Livingstone Exchange.⁵ Working and reserve carrier equipment is installed at Museum and Livingstone. Remote-control equipment is provided at Museum for normal-to-standby changeover at Livingstone. The video signal continues from Livingstone over the final 200 yd. to the transmitter on 0.375-in. coaxial cable. The coaxial tube is equipped with longitudinal chokes as a precaution against low-frequency interference, and programme indicators fitted at Museum and at the transmitter itself provide a constant check on the continuity of the circuit.

As a precaution against interference from the strong electro-magnetic field of the nearby transmitter, the equipment at Livingstone is installed in a screened room which has been erected temporarily on the floor of the apparatus room and is located over the end of the development area of the main distribution frame. The coaxial cables are thus able to enter the screened room vertically through the entry ducts already provided. At the point of entry all cables, including audio and power cables, are bonded to a copper plate which is electrically continuous with the floor-screening material. An earth connection is also applied at this point. Filtration, for those audio circuits which have become exposed to the field before entering or after leaving the room, is provided by suppression filters mounted in a box at the point of cable entry. The wires of each circuit pass through the internal screened compartments via two lead-through capacitors which, together with the inductance of the connecting wires, form a low-pass section having a loss exceeding 60 db. at frequencies above 50 Mc/s. The room, being only a temporary structure, is made in the form of a cage of 25-S.W.G. tinned-copper mesh supported on a wooden framework, and duplicate doors allow entry to the room without breaking the screen continuity.

THE INTER-CITY NETWORK

The broad outline of the new inter-city network, shown in Fig. 7, has passed the initial planning stages. To obtain the necessary rapid expansion required for the success of the new television venture all available spare plant will be used and the temporary appropriation of line plant which has already been provided in anticipation of long-term telephony growth will be necessary.

The London-Birmingham 900 Mc/s radio-relay link⁶ which was provided in 1949 to extend the B.B.C. service to the Midlands, and subsequently became spare when that service was transferred to coaxial cable, has been overhauled and fitted with new modulators. At Museum, London, and Telephone House, Birmingham, the radio-relay link has been re-terminated on the new video distribution racks, the short coaxial tie circuits from the roof huts have been modified to operate at video frequency, and echo-type waveform correctors have been fitted. A further uni-

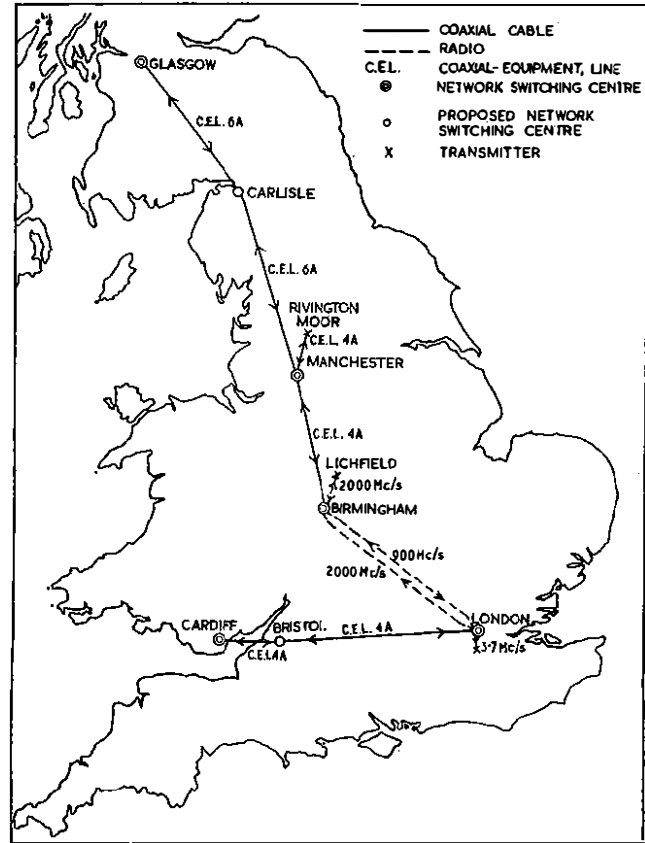

FIG. 7.—THE INTER-CITY NETWORK.

directional circuit operating at 2,000 Mc/s between London and Birmingham is planned and this will share building sites and aerial towers with the 900 Mc/s system.

The transmitter tail to Lichfield is being provided as an independent radio circuit from the N.S.C. at Telephone House, Birmingham; two channels, including one reserve, operating in the outgoing direction and one channel in the incoming direction, using frequencies in the region of 2,000 Mc/s. Both outgoing channels will be energised simultaneously. The radio transmitter for this tail will be in the N.S.C. at Telephone House, Birmingham, the output at 2,000 Mc/s being fed along 147 ft. of coaxial feeder to the aerial on the roof.

The system is so designed that the video signal is applied to a phase-shift frequency modulator⁷ which translates the signal into the intermediate-frequency spectrum centred on 60 Mc/s. The application of the video waveform at a level of 1 volt peak-to-peak results in a total deviation of 6 Mc/s. A further translation shifts the signal to the 2,000 Mc/s range, the wanted frequency band being chosen by means of a coaxial-line filter. Three stages of amplification follow, using disc-seal triodes, which raise the signal to a level suitable for application to the aerial. The 8-ft. diameter paraboloid aerial, to which both transmitters are connected through a combining network, has a gain of 31 db.

At the receiver the incoming V.H.F. signal is applied to a silicon-diode mixer which translates the signal into the intermediate-frequency spectrum. Recovery of the video signal is effected in a limiter-discriminator which is followed by the final video amplifier.

The remainder of the network shown in Fig. 7 will be provided initially on coaxial cable by appropriating spare coaxial tubes as necessary, but the circuits may be transferred to radio systems or to other cables when the appropriated plant is replaced. Short lengths of new cable

will be provided in the Cardiff and Glasgow areas and over a difficult moorland route between Horwich and Rivington Moor.

Transmission throughout the main coaxial-cable network will be in the 0.5-4 Mc/s spectrum using the vestigial-sideband principle. With the exception of that between Manchester and Glasgow, the broadband transmission path between each N.S.C. will be equipped with Coaxial-Equipment, Line, No. 4A. This is similar to the earlier form of television coaxial line equipment,⁸ but modification of the overall gain and of the pilot filter responses has made it adaptable for either television or multi-channel telephony. A number of other changes have also been made, including the provision of improved supervisory facilities and the use of balanced power feeding.

The Manchester-Carlisle-Glasgow route will be the first operational television route in the United Kingdom to be equipped with Coaxial-Equipment, Line, No. 6A, although an early version of a similar type of line-regulated system has been installed on the section of the Continental television link between London and St. Margaret's Bay. The design of the new line equipment is based on the principle that the predominant changes in response of the system will be due to variations in attenuation of the cable with temperature. The changes follow a root-frequency law and will be corrected by using a pilot of 4,092 kc/s which will suitably control the gain of all the intermediate amplifiers. The three-stage line amplifier uses three pairs of parallel valves and operates at high efficiency due to the incorporation of networks designed to provide maximum coupling to line at the highest transmitted frequency. Because of the presence of the output-coupling network the signal level to line increases with frequency.

The power supply is balanced to earth and is fed over two coaxial tubes, at 1,000 volts, to six repeater stations on each side of the power-feeding station.

On all coaxial-cable carrier circuits the broadband spectrum will be temperature corrected and fully equalised for minimum attenuation and delay distortion.

All coaxial line links will be equipped with an improved design of 0.5-4 Mc/s terminal translating equipment wherein the video input signal is clamped and modulated in a negative sense on the 1.056 Mc/s carrier; i.e., an increase in picture brightness corresponds to a fall in the amplitude of the carrier waveform. Stable balances, which are independent of power-supply variations, are obtained in the two modulation stages by the use of germanium-crystal modulators of lattice configuration. The 1.056 Mc/s carrier is transmitted to line at a high level relative to the picture information, the corresponding modulation depth being approximately 40 per cent. with a sinusoidal input of peak-to-peak value equivalent to that of the video waveform. At the demodulator, the use of envelope detection to recover the video signal results in the output undergoing some small degree of non-linear distortion due to the partial suppression of the lower sideband. Like the broadband line equipment the terminal translating equipments are equalised to within suitable limits of attenuation and delay distortion. Further correction, to the required degree of accuracy, is then applied to the waveform response by the addition of corrector networks.

Each link terminating at a N.S.C. is equipped with an echo-type waveform corrector and a set of test and monitor racks; the final overall alignment being completed on a waveform basis with the aid of the echo-type waveform corrector.

VISION-NETWORK PERFORMANCE

The question of deciding suitable design objectives for the network as a whole was considered at an early stage by a special study group formed from engineering repre-

sentatives of the I.T.A., the programme contractors, and the Post Office. Overall vision-network performance had previously been stated in terms of a total circuit length of 500 miles made up of four main links in tandem⁸ but the greater complexity of the new network seemed to demand the consideration of a more elaborate arrangement. The 500-mile circuit consisting of four main links was retained as being representative of a typical nation-wide broadcast requirement. However, the need to inter-connect studios, programme switching centres, and transmitter tails indicated that the design objective should allow for the addition to the main 500-mile circuit of a number of short links at various points. It was therefore agreed that target performance standards should be based on obtaining satisfactory transmission over a circuit consisting of four main links and nine short links in tandem, a maximum not likely to be exceeded during normal operation of the network.

The vision-circuit design objectives are:—

Waveform Distortion.—Waveform distortion⁹ can be analysed into a main distortionless term on which are superimposed a number of echo terms, or attenuated replicas of the main term, spaced in time at equal intervals before and after the main term. The target performance for waveform distortion is expressed in terms of a distortion rating factor K , which is usually stated as a percentage.¹⁰ The factor is a function of the amplitudes of the echo terms relative to the amplitude of the main term and is closely related to the actual degree of picture impairment. Distortion ratings for individual links tend to add on a random basis, so that the overall rating for a number of identical links varies as the square root of the number of links. More generally, the overall distortion follows the root-sum-square rule, e.g. three links having distortion ratings of 1 per cent., 2 per cent. and 3 per cent., would behave as a link of rating $K = \sqrt{(1^2 + 2^2 + 3^2)}$ per cent. = 3.74 per cent. The overall design objective for four main links and nine short links in tandem is 4.5 per cent.

Distortion is assessed by observation on a cathode-ray oscilloscope of a test waveform derived from a pulse-and-bar generator. The test waveform consists of synchronising pulses, similar to those of the line synchronising signal in the standard television waveform, and a picture signal consisting of a sine-squared pulse¹¹ of either 0.17 microsecond or 0.33 microsecond duration and a bar of 40 microseconds duration having a time-of-rise corresponding to that of the chosen sine-squared pulse.

Attenuation Distortion.—Between any two terminal points on the network the gain at any frequency in the video spectrum should not exceed the gain at 10 kc/s by more than an amount in decibels numerically equal to the percentage distortion rating. This restriction guards against the possibility of overload.

Non-Linear Distortion.—Non-linearity affects the waveform response in many different ways; but, for the transmission of monochrome pictures, it is usually sufficient to consider only synchronising pulses and picture highlights. The design objective aims at maintaining the amplitude of the synchronising pulses within +10 per cent. and -20 per cent., and the picture black-to-white amplitude within ± 10 per cent., of their nominal levels. Measurement is made on a cathode-ray oscilloscope using a television-type test waveform corresponding to a bar at the centre of each line, which can be expanded from 2 microseconds to full line duration.

Noise.—Noise is expressed as the ratio,
$$\frac{\text{black-to-white picture voltage}}{\text{peak-to-peak noise voltage}}$$
and the design objectives for the network are that the noise should not be worse than:—

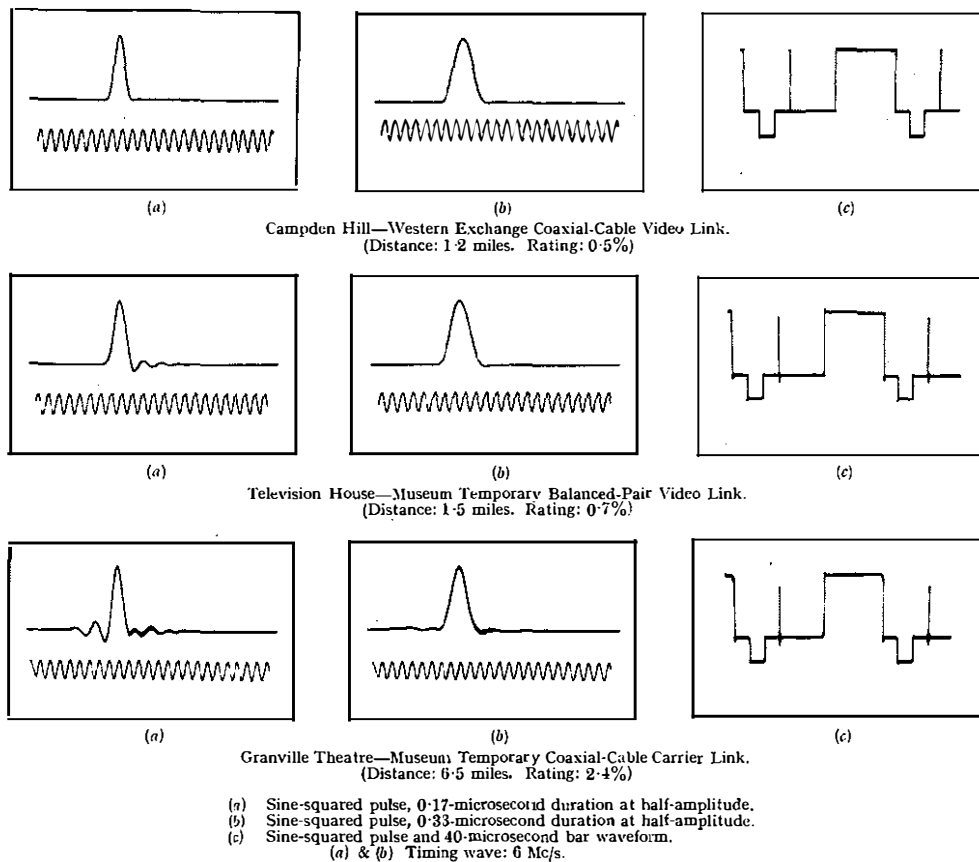

FIG. 8.—WAVEFORM RESPONSES AND DISTORTION RATINGS OF THREE OF THE CIRCUITS IN LONDON.

(a) Uniform spectrum noise ..	35 db.
(b) Triangular spectrum noise ..	27 db.
(c) Periodic noise, excluding hum	50 db.
(d) Hum	30 db.

The normal insertion of black-level clamps at the transmitters and at programme presentation points will prevent the overall hum level from rising to undesirable proportions.

Gain and Gain Stability.—Each link will be maintained to within ± 0.25 db. of its nominal gain at 10 kc/s and the overall gain of four main links in tandem should not vary by more than ± 1 db. in any period of one hour.

Test Results.

The waveform responses of three of the London studio circuits, together with their distortion ratings, are shown in Fig. 8. Many of these circuits were initially provided with temporary equipment and consequently some of them absorb an undue proportion of the overall design objective of 4.5 per cent. However, the permanent replacement equipment will become available as the main network grows; so that, when the extension to Scotland is completed, the London circuits will have been realigned to give their optimum performance.

Despite the temporary nature of much of the local network the transmission quality has been of a standard sufficiently high to satisfy the exacting requirements of the I.T.A. and the programme companies.

ACKNOWLEDGMENTS

Fig. 3 is reproduced by courtesy of Standard Telephones & Cables, Ltd.

The author gratefully acknowledges the assistance given

in the preparation of this article by colleagues in the Engineering Branch of the London Telecommunications Region, and in the Engineer-in-Chief's Office, all of whom, together with cable and equipment contractors, by their outstanding efforts and excellent teamwork, made possible the opening of the Independent Television service, with full facilities, in London on the appointed date.

References.

- ¹ Wolstencroft, A. Setting up the Independent Television Authority. *Post Office Telecommunications Journal*, Vol. 7, p. 93, May-Jul. 1955.
- ² Linke, J. M. A Variable Time-Equaliser for Video-Frequency Waveform Correction. *Proceedings I.E.E.*, Vol. 99, Part IIIA, p. 427, 1952.
- ³ Kilvington, T., Laver, F. J. M., and Stanesby, H. The London-Birmingham Television Cable System. *Proceedings I.E.E.*, Vol. 99, Part I, 1952.
- ⁴ Williams, M. B., and Sewter, J. B. The Provision of Circuits for Television Outside Broadcasts. *P.O.E.E.J.*, Vol. 48, p. 166, Oct. 1955.
- ⁵ Regional Notes (L.T. Reg). *P.O.E.E.J.*, Vol. 48, p. 119, Jul. 1955.
- ⁶ Clayton, R. J., Espley, D. C., Griffith, G. W. S., and Pinkham, J. M. C. The London-Birmingham Television Radio Relay Link. *Proceedings I.E.E.*, Vol. 98, Part I, p. 204, 1951.
- ⁷ Ravenscroft, I. A., and White, R. W. A Frequency Modulator for Broad-Band Radio Relay Systems. *P.O.E.E.J.* Vol. 48, p. 109, Jul. 1955.
- ⁸ Halsey, R. J., and Williams, H. The Birmingham-Manchester-Holme Moss Television Cable System. *Proceedings I.E.E.*, Vol. 99, Part IIIA, p. 398, 1952.
- ⁹ Lewis, N. W. J. Waveform Computations by the Time Series Method. *Proceedings I.E.E.*, Vol. 99, Part III, p. 294, Sept. 1952.
- ¹⁰ Lewis, N. W. J. Waveform Responses of Television Links. *Proceedings I.E.E.*, Vol. 101, Part III, p. 258, Jul. 1954.
- ¹¹ MacDiarmid, I. F. A Testing Pulse for Television Links. *Proceedings I.E.E.*, Vol. 99, Part IIIA, p. 436, 1952.

Accelerated Life Tests in the Investigation of Mechanical Performance

M. MITCHELL, M.B.E., E.R.D., B.Sc.(Eng.), A.M.I.E.E.,
and E. W. C. HUBBARD†

U.D.C. 620.171.313—185.4

Accelerated life tests are an important means of investigating the mechanical performance of relays, uniselectors and two-motion selectors. In this article the authors discuss the points to be considered in carrying out such tests and the methods adopted, with particular reference to the control circuits used.

INTRODUCTION

IN investigating the electrical performance of a newly-developed relay set or selector circuit it is normal for functional tests, under appropriate adverse conditions if necessary, to be carried out in the laboratory before bringing the equipment into service or submitting it to a field trial. Laboratory tests are no less necessary when investigating the mechanical performance of apparatus used in automatic telephony, and the need to produce the maximum amount of information in a given time has led to the extensive use of accelerated life tests. In such tests the apparatus is subjected to wear at a higher rate than it would experience in service, and from a study of its performance and measurements of the wear of individual components, deductions as to its life in the field may be made, or comparisons drawn between different samples. The factors to be considered in carrying out such life tests and the methods adopted in the Telephone Branch Circuit Laboratory are described below.

FACTORS TO BE CONSIDERED IN LIFE TESTS

Among the factors to be considered in conducting life tests, as influencing the results obtained or the conclusions drawn, the most important are:—

- (a) The rate at which the test should proceed, i.e. the degree of acceleration in time compared with normal use of the equipment in the field.
- (b) The number of samples to be tested.
- (c) The frequency of inspection, re-adjustment, cleaning and lubrication.
- (d) The atmospheric conditions, i.e. temperature, humidity and presence of impurities.
- (e) The means of isolating faulty equipment for the identification and recording of faults and as a precaution against fire.

In the following paragraphs the significance of these factors and the conditions governing their choice are discussed.

RATE OF TESTING

Although the necessity to produce as much information as possible from an accelerated life test within a given time points to the desirability of having as rapid a rate of testing as possible, several considerations limit this rate in practice. The apparatus itself must generally be tested within the specified conditions of adjustment and operation, and the normal limitations on self-interrupted stepping speed or on input pulses will therefore apply. Moreover, rest periods must follow successive operations to avoid overheating and an excessive rate of wear. In general, for mechanisms the rest period is made at least equal to the running period. In certain instances, however, the rest period must be considerably longer, e.g. for motor-driven uniselectors, adequate time must be allowed for the latch magnet to cool and for this reason the rest period is normally four times the running period.

†The authors are, respectively, Senior Executive Engineer and Assistant Engineer, Telephone Development and Maintenance Branch, E.-in-C.'s Office.

With the above limitations, and even with the tests themselves running continuously, it may not always be possible under life-test conditions to reduce by a factor of more than two or three the time which the apparatus concerned takes to perform a given number of operations in service in the field. This, of course, applies particularly to the items of apparatus which are most heavily worked in service and which are therefore the most important items for investigation. For comparatively lightly worked items, however, the reduction in time under laboratory tests may be very considerable. The examples given in Table 1 indicate the degree of acceleration in time which may reasonably be achieved, the times quoted for the items to perform the given number of operations in the field being necessarily very approximate.

TABLE 1

Item	Number of operations	Approximate minimum time to perform operations	
		In service	In laboratory under life test
3000-type Pulsing Relay	50 million	5 years (as Director "A" relay)	3 years
3000-type Relay (General Purpose)	30 million	30 years	4 years
Type 2 Uniselectors	4 million half-revolutions	2 years (as Director Send Switch)	1 year
Type 3 Uniselectors	1 million half-revolutions	15 years (at a P.B.X.)	6 months
Motor-driven Uniselectors	4 million half-revolutions	8 years (as Trunk Group Selector)	2 years
Two-Motion Selectors	1 million calls	2 years (as "A" Digit Selector)	1 year

NUMBER OF SAMPLES TO BE TESTED

Before any useful deductions can be made from a life test it is clearly necessary that a number of samples should be tested. Practical considerations, however, limit the number on any one test, and different considerations apply to the testing of prototype, as distinct from production, samples.

In many instances prototypes are hand-made items constructed in a model shop by skilled craftsmen and, in some respects, are superior to samples from a production line. The number of prototypes to be subjected to test is therefore of less importance as the life tests are intended to indicate the suitability of a given design or the desirability of alternative materials, rather than reveal future maintenance difficulties due to production methods, or to check that the manufactured product will meet the specified standard.

In general, with production samples of relays, uniselectors and two-motion selectors, 10 samples are simultaneously tested, or if more than one manufacturer is concerned, 10 from each manufacturer. Usually, consistent results are obtained in that failures due to defects occurring in one sample also occur at some stage in the life test on the other samples under test. Fig. 1 illustrates such a case,

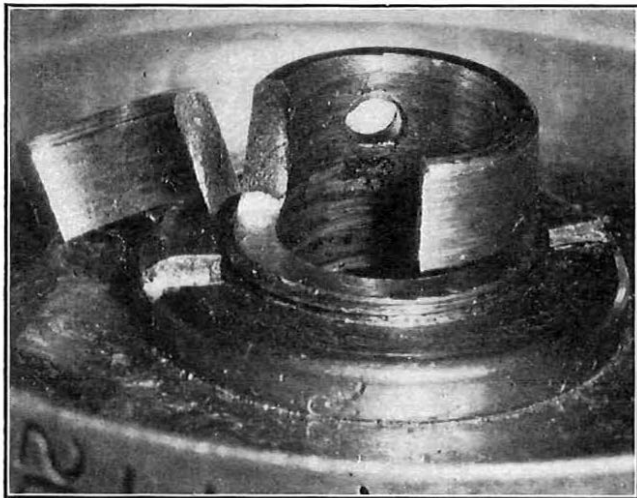

FIG. 1.—FRACTURE OF UNISELECTOR WIPER HUB.

a fracture of the wiper hub of a Type 2 Uniselector, which occurred in the particular sample after the uniselector had completed 290,000 half-revolutions. Similar failures occurred in other samples after lives of from 750,000 to 3,700,000 half-revolutions.

FREQUENCY OF INSPECTION, READJUSTMENT, CLEANING AND LUBRICATION

During a life test, the samples are under regular observation, from which the necessary frequency of cleaning and lubrication can generally be determined. Dismantling the samples for inspection is avoided, unless it is specifically required to measure the extent of wear on particular components at pre-determined intervals, because it creates artificial disturbance of moving parts and foreign matter. In this connection, it is often necessary to isolate the effects of purely mechanical wear and electrical wear, e.g. in the case of contacts and wipers breaking circuits carrying current, a condition which will be considerably aggravated by contact bounce. In a typical life test on production samples of Type 2 Uniselectors, extending to four million half-revolutions, the uniselectors are examined and overhauled after every one million half-revolutions; similarly, for production samples of Type 3 Uniselectors with a total life test of one million half-revolutions, there is examination and overhaul after each 250,000 half-revolutions. With prototype apparatus or with modifications to standard apparatus, no fixed intervals can be laid down and it has been found advisable to carry out examinations at much more frequent intervals in the early stages of the test than in the later stages. For example, a detailed examination for loss of block lift on a modified 3000-type relay might be carried out initially at intervals of 100,000 up to one million operations, then at intervals of one million up to five million and thereafter at successive intervals of five million operations.

Cleaning is seldom necessary during accelerated life tests, as it is difficult to accelerate the deposition of dust to a degree commensurate with the accelerated test cycle. Lubrication, however, needs close attention throughout the tests, if undue acceleration of wear is to be avoided.

ATMOSPHERIC CONDITIONS

In certain tests; for example, in investigating the effects of different samples of lubricating oil at lower temperatures than normally obtain in automatic exchange working, special measures such as enclosing the apparatus under test in a refrigerator may be necessary. Usually, however, the tests proceed at normal temperature and humidity although they are conducted in enclosed cubicles to permit the atmospheric conditions to be controlled. Sometimes it may be necessary to assess the effect of airborne dust in the atmosphere. The airborne dust may be abrasive, in which case it will influence the rate of wear of mechanical components, or corrosive, when it may influence both mechanical components and electrical connections. Again it may consist of organic impurities such as hair, fluff or textile particles, which will influence the reliability of electrical connections and cause, for example, relay contact failures. For some tests in a "dusty" atmosphere, dust has been collected from an automatic exchange in London and agitated in a box placed in the life-test cubicle.

CONTROL EQUIPMENT

Since the test samples are required to operate continuously and are, of course, unattended at night and at weekends, it is necessary to safeguard equipment from any fire risk arising from overheated magnets and coils. The control equipment for the life test is therefore arranged to isolate automatically from the battery any faulty equipment.

The control equipment must also impose on the test samples electrical conditions which will simulate their normal working conditions, and the control circuits are therefore designed to include elements from standard circuits. The importance of this factor is illustrated in Fig. 2 which shows, for a Wiper No. 12, the relatively slight mechanical wear involved in the completion of 1,000,000 calls by the selector concerned when no electrical load was being carried, and the wear to destruction after 500,000 calls when the wiper was used under certain specified circuit conditions. The choice of the particular circuit

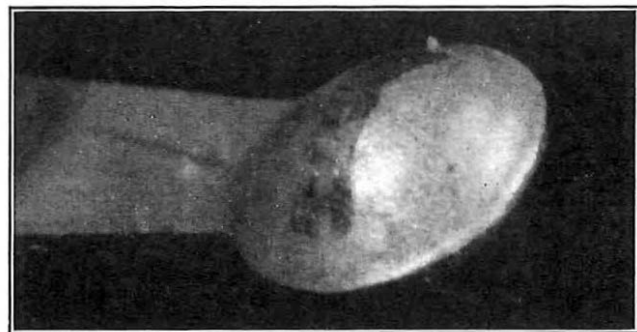

(a) Mechanical Wear on Wiper after 1,000,000 Calls

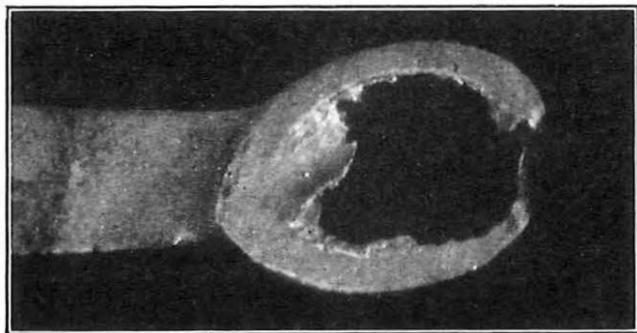

(b) Electrical Wear after 500,000 Calls

FIG. 2.—WIPER NO. 12.

elements used will, of course, be governed by the aspect of performance being investigated.

In general it is desirable that the connections between the control circuits and the test samples should be kept to a minimum. For example, one contact only on a mechanically-operated spring-set need be used (operating a relief relay on the control equipment if necessary), the remaining spare contacts, wipers, etc., being available for applying special test conditions. A common control circuit is used to serve a number of test samples as this permits a more direct comparison between samples, and simplifies the faulting of the control equipment by producing the same fault condition on all the samples. A visual display is arranged to indicate the progress of the test cycle and to assist in detecting failures.

Since the control equipment will itself contain apparatus having a life comparable with that of the apparatus being tested it is essential to know, and to take account of, its limitations. Thus standard items of apparatus, if incorporated, are mounted and wired as replaceable units.

It is usual to arrange for the cycle of testing on selectors to include the following stages:—

- (a) Verifying that the sample is in its home or normal position and marking the outlet on which it is to stop.
- (b) Driving the sample to the marked outlet.
- (c) Checking that the sample has stopped at the marked outlet.
- (d) Restoring the sample to its home position.

Uniselectors, if tested in pairs, can be arranged to be self-checking on any number of marked outlets by suitably cross-connecting their banks, but two-motion selectors require a marker on the bank multiple. These aspects of the control equipment are dealt with more fully in subsequent paragraphs describing typical control circuits.

When a fault occurs on a sample under test it is not always necessary to stop the life test. For example, if during unattended periods a faulty sample mechanism fails to restore, a forced-release condition may be applied to permit testing to proceed on the remaining samples. Again, depending on the investigation, certain anticipated faults may be automatically recorded during the test without delaying the progress on the test other than to record their occurrence. Examples of the types of fault which have been detected in this manner are:—

- (a) The double homing of uniselectors.
- (b) Intermittent or premature disconnections on mechanically-operated spring-set contacts.
- (c) High electrical resistance of wiper to bank contact connections.

TYPICAL CONTROL EQUIPMENT FOR LIFE TEST OF TWO-MOTION SELECTORS

This equipment satisfies the requirements of nearly all life-test investigations on two-motion selector mechanisms and is used for 2000-type and S.E.50-type mechanisms. Provision is made for testing a maximum of 10 mechanisms, which are mounted on two shelves and, together with the control circuits, occupy a rack 7 ft. × 2 ft. 9 in. A block schematic diagram is reproduced in Fig. 3.

Basically the equipment consists of a Test Relay Set to which the mechanisms under test are allotted in turn. The Test Relay Set comprises all the necessary circuit elements to permit the mechanism to function as a

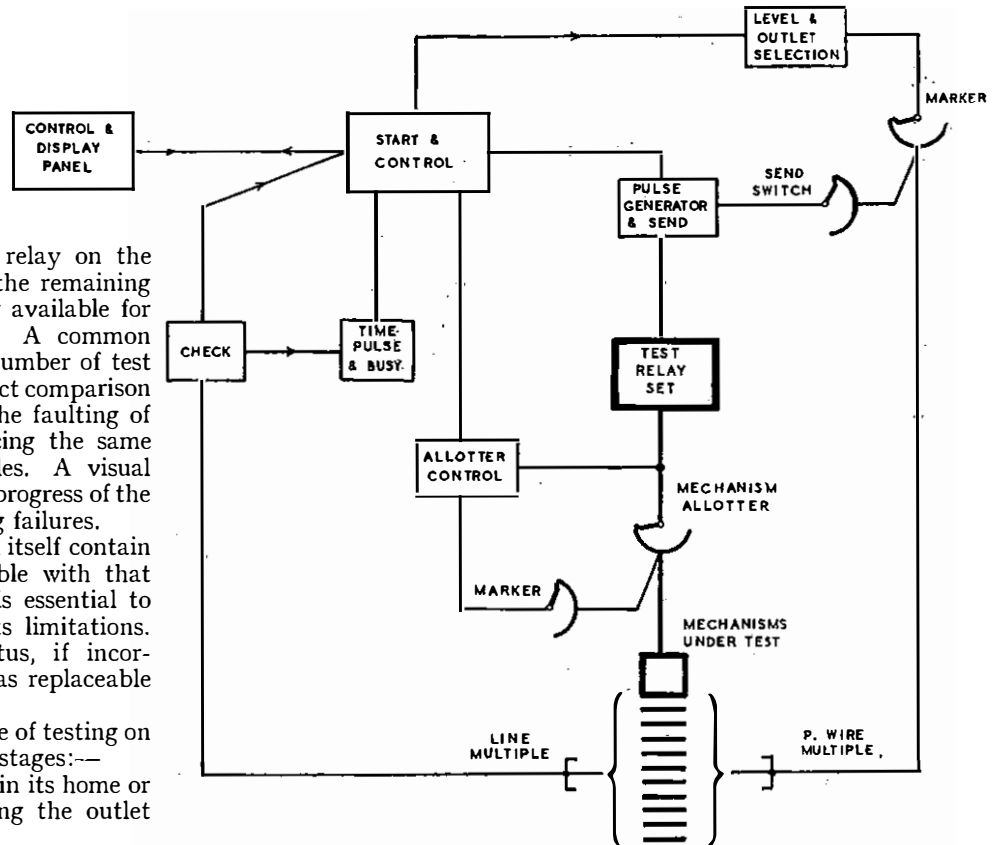

FIG. 3.—TEST CIRCUIT FOR TWO-MOTION SELECTORS.

particular selector (e.g. Linefinder, Group or Final Selector) and includes an element to simulate a subsequent switching stage. The type of Test Relay Set employed will depend on the particular feature to be investigated and the sample mechanisms will be equipped accordingly. An additional Test Relay Set may be used if two mechanisms require testing simultaneously.

The facilities offered by the equipment and the functions of its component parts are listed below:—

- (a) *Control and Display Panel.* Provides a means of initiating the start signal; registers the number of test calls performed by each sample; displays progress of the test cycle; identifies a faulty sample mechanism; and transfers progress to manual control and repeats particular phases of the test cycle when required to assist fault location.
- (b) *Start and Control Relay Set.* Stores and distributes the start signal during the test cycle, subject to the test progressing satisfactorily.
- (c) *Allotter Control Relay Set and associated Marker.* Ensures that the sample mechanisms are allotted in turn to the Test Relay Set after first ascertaining that the mechanism was not rejected as faulty during a previous test cycle. The mechanisms are allotted after performing a given number of test calls, usually 10, comprising one call per level.
- (d) *Mechanism Allotter.* Provides connections between the magnets, wipers and spring-sets of the mechanisms and the Test Relay Set in accordance with the relative standard selector circuit diagram.
- (e) *Level and Outlet Selection Relay Set and associated Marker.* Selects the level and outlet to which the sample mechanism is to be stepped. Only one outlet in the bank is marked at any one time and the level and outlet is changed after every test call. A maximum of 20 different markings is available. The type

of marking depends on whether an earth-testing or battery-testing circuit is employed and is applied to the P-wire multiple of the mechanisms under test.

(f) *Pulse Generator and Send Relay Set.* Provides pulses of 66 per cent. make and 33 per cent. make at 10 p.p.s. for controlling the Send Switch and the Test Relay Set "A" relay. The required number of pulses for each test call is counted off on the Send Switch according to the marking provided by the level and outlet selection circuit. Either one or two trains of pulses may be obtained for each test call, depending on whether a Group or Final Selector Test Relay Set is employed. The start signal is not conveyed to the pulse generator when a Linefinder Test Relay Set is employed and the Send circuit is used merely to seize the Test Relay Set.

(g) *Check Relay Set.* This is connected via the line bank multiple and proves that the mechanism has positioned its wipers on, and that the Test Relay Set has correctly switched to, the outlet selected by the marker. The receipt of the check signal permits the control circuit to release the call and, on restoration of the mechanism to normal, to initiate another test call.

(h) *Time Pulse and Busy Relay Set.* If a mechanism develops a fault which affects the correct sequence of operations during a test cycle, the time-pulse circuit automatically "busies out" the faulty mechanism, signals the control circuit to apply the necessary reset conditions, and permits the test to proceed on the next sample mechanism. In the event of all mechanisms becoming busied out, the start condition is removed from the control circuit and the test suspended. Alternatively, the test may be suspended, if required, when any one mechanism develops a fault. The time pulse circuit will also suspend the test if failure occurs on the control circuits and, additionally, disconnect the battery supply if any magnet coil becomes permanently energised.

TYPICAL CONTROL EQUIPMENT FOR LIFE TEST OF MOTOR-DRIVEN UNISELECTORS

To provide a ready means of checking the performance of motor-driven uniselectors on life test the samples are arranged in pairs, each pair being tested in sequence. The control circuit subjects the uniselectors to the circuit conditions imposed when used as a Group Selector (motor-unisector type). During the test cycle the uniselectors stop at two positions in the bank (contacts 14 and 34) and then return to the "home" position (contact 51) under the control of the cam springs. A life-test control circuit is shown in Fig. 4 and a brief description follows. (*Note.*—Relay HB is operated at the commencement of a test cycle.)

Two bridging wipers on each unisector are used as testing wipers to which are connected the high-speed cut-drive relays SA and SB and their associated battery markings via 550-ohm resistors. The wiper connections are commoned, where shown, to the remaining samples under test.

The banks of each pair of uniselectors are cross-connected

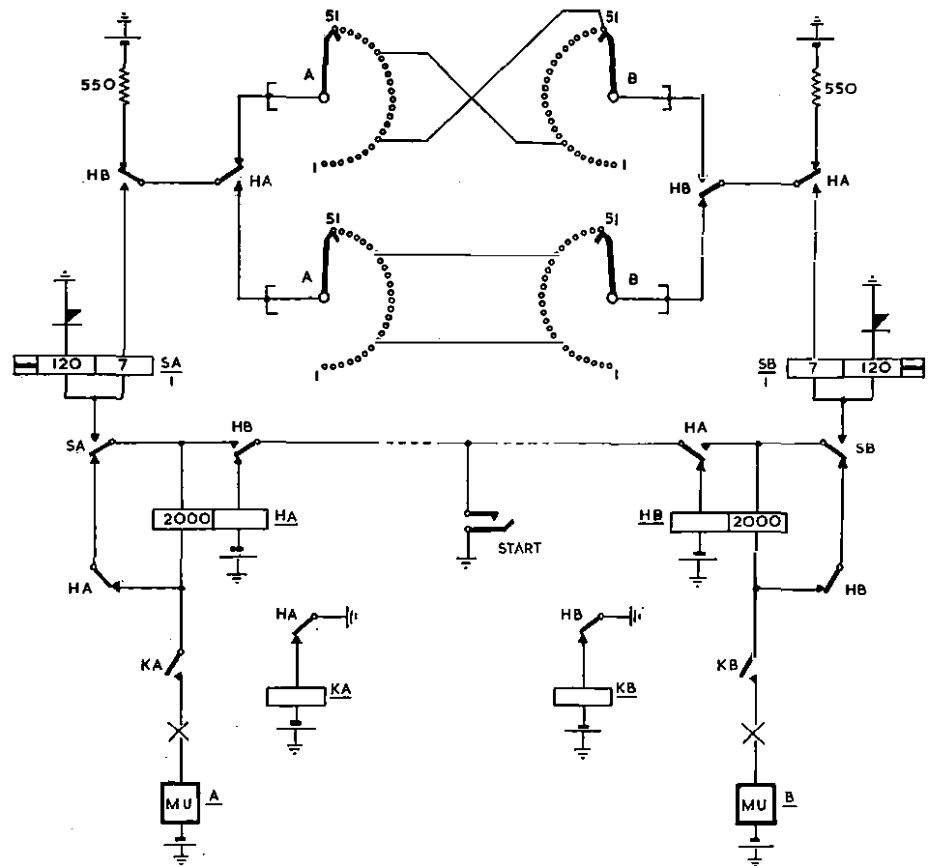

FIG. 4.—TEST CIRCUIT FOR MOTOR-DRIVEN UNISELECTORS.

in such a manner that the marking battery is extended to one unisector of a pair only when the wipers of the associated unisector are correctly positioned.

A further wiper on each unisector is used to check that the uniselectors have stopped on all the marked contacts in turn and returned to the home contact before the start condition is transferred to the next pair of uniselectors. The unisector mechanisms are allocated to the control circuit via changeover contacts.

If a unisector fails to stop at the marked contact or home contact a release alarm relay (in series with the battery supply to the unisector mechanisms) is arranged to suspend the test before the wipers complete a half revolution and attempt to test the contact for a second time.

CONCLUSION

Life test results for any item cannot necessarily be regarded as an accurate forecast of its behaviour in the field. For example, a recent analysis of the fault returns from the field for 2000-type selector mechanisms has revealed the fault rate per selector per million calls to be approximately double that experienced during a laboratory life test.

During a life test, equipment does not function under conditions identical with those encountered in the field; items are subjected to a higher rate of wear than would obtain in service, and an artificially high standard of maintenance is imposed during the life test due to the comparatively few items concerned and the necessity for accurate diagnosis and clearance of faults to permit testing to continue. Therefore slight defects or deviations beyond the specified adjustment tolerances are likely to be observed and rectified more readily than would be the case in the field.

Experience has shown that life tests have contributed in some measure to improvements in manufacture and have enabled modifications to be incorporated in items which might otherwise become maintenance liabilities in the field.

A New Cable-Drum Trailer

J. J. MOFFATT, A.M.I.Mech.E., A.M.I.E.E.

U.D.C. 629.118.7:621.315.292

This article describes a new cable-drum trailer, incorporating several novel features, which can be used for transporting cable drums weighing up to 4 tons.

INTRODUCTION

TO the layman the handling of cable drums probably appears a simple matter, but when considered on a large scale a number of important engineering, economic and legal requirements must be satisfied.

It is essential that any cable-drum-carrying device shall be as light in weight as possible, consistent with the ability to carry the heaviest drum which it will be required to transport, so that running costs are not increased by repeatedly moving large masses of ironwork during the life of the device. The weight of a trailer also determines certain legal requirements, since the Road Traffic Acts permit trailers constructed to carry separable loads and having an unladen weight of under one ton to have their brakes operated on the over-run principle. Hence, a cable-drum trailer weighing less than one ton may be towed by any vehicle capable of towing the combined load of the trailer and full cable drum, irrespective of the vehicle braking system. Large vehicles used to convey heavy drums to a works site can be released for other duties and the empty drums and lightweight trailer may be returned to depot using the gang vehicle.

The new cable-drum trailer described in this article has the advantage of light weight and also incorporates a number of novel features.

DESCRIPTION OF NEW TRAILER

A pair of heavy-duty road wheels supports the main chassis framework, which consists of an open-ended assembly that may be wheeled around a drum or into which a drum may be rolled—the alternative methods catering for different conditions such as unmade ground, restricted site conditions, full or empty drums, etc. When in position within the framework the drum is raised on a special spindle by means of a pair of lever-operated screw jacks mounted on the framework. A tie-bar, shown in the opened position in Fig. 1, is then clamped across the open end of the framework. The laden trailer is then coupled to the towing vehicle and the small front castor-wheel raised.

The simple operations involved reduce the time and manpower taken to prepare a cable drum for road transportation to a small fraction of that required for other methods, and all the operations are performed without risk

of mishap or injury to the personnel concerned.

On arrival at the working site, the laden trailer may be suitably placed and the cable fed directly off the drum without further preparatory operations—other than removing the battens from the drum.

Main Framework.

To obtain the required simplicity in use the main framework has been designed in the general shape of a wishbone. By so positioning the load that its weight is centred and supported as directly as possible over the main road wheels, the stresses in the framework due to the static load are greatly confined and are so simplified that the predominating requirement in the design of the framework becomes one of catering for the dynamic stresses, i.e., the stresses that arise due to the momentum of the load when travelling, starting and stopping rapidly, crossing uneven ground, etc.

The tie-bar clamped across the open end of the framework greatly limits the independent flexing of the limbs and consequently the fatigue that could arise on the welded joints of the framework if the limbs were free. To provide a firm attachment capable of meeting the stress requirements while at the same time keeping the tie-bar light enough for easy handling, use is made of a 4-in. diameter hardened aluminium-alloy tube containing at each end a left- and right-hand threaded screw operating a pair of jaws. The jaws engage on dovetail projections provided at the end of the main limbs of the framework.

The towing yoke is less highly stressed and is therefore fabricated from rolled-steel sections smaller in size than the main limbs, although large enough to cater for the lateral stresses due to yawing.

Suspension.

In an earlier design the two main road wheels were supported on stub axles but this was quickly proved to be unsatisfactory under overload test conditions due to the torsion applied to the main members. To eliminate this torsion the road wheels have been enclosed in a rectangular sub-frame that is hinged to the main framework at the front and supported on substantial coil springs (compression) at the rear. The wheel axle is of the push-out type and is equally supported at each end by the sub-frames. This unorthodox method of suspension has largely eliminated the flexing of the main framework and has proved very satisfactory under a wide range of field conditions.

Even when carrying a test load of $4\frac{1}{2}$ tons and travelling over specially selected rough, undulating ground at the highest speed the vehicle could be driven on such terrain, the load did not bounce but "floated" gently.

Jacking Features.

To enable the cable drums to be raised to their travelling position when within the framework, a screw jack is provided on each of the main framework limbs. These jacks are operated from a position outside the main road wheels by means of a ratchet lever. To enable the operating levers to be at a uniform height irrespective of the great (for screw jacks) travel of the lifting hook, the motion is transmitted to the top of the jacks and applied to the main lifting screws by spur gearing. The effort required to raise a drum of maximum weight is of the order of 50 lb. When the drum has been raised sufficiently the operating levers

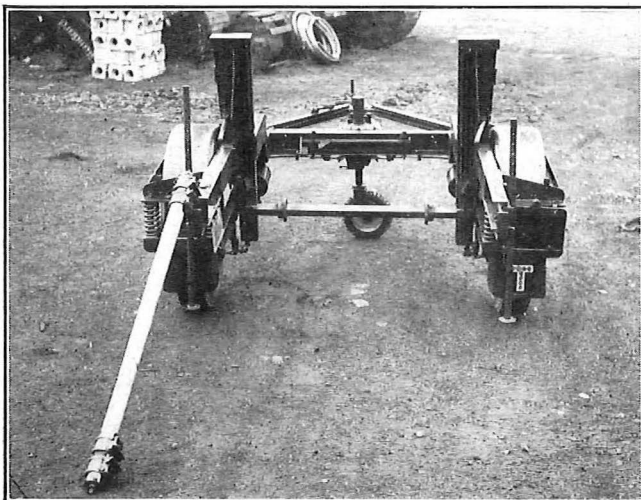

FIG. 1.—REAR VIEW OF TRAILER.

are latched in a position parallel to the main limbs of the framework.

The main lifting hooks have phosphor-bronze bushes to permit easy running on the steel lifting screws, and the actual hook portion contains a pin to secure the cable-drum spindle when travelling unladen over rough ground.

Adjustable cheeks, as shown in Fig. 1, are provided on the cable-drum spindle to enable the drum to be centralised on the spindle or to enable a wide drum to be so positioned that the tail end of the cable, which usually projects through the flange of the drum (see Fig. 2), will not be damaged when the drum is rotated to pay off cable.

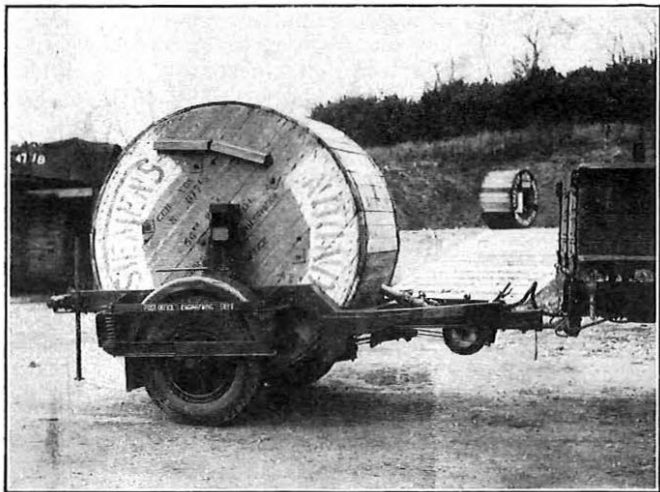

FIG. 2.—TRAILER WITH CABLE DRUM IN POSITION.

For easy wheel-removal for tyre maintenance, etc., a simple one-piece prop is engaged on either of the cable-drum lifting hooks so that, by lowering the lifting hook, the trailer wheel can be raised (see Fig. 3), allowing the wheel axle to be drawn out and the wheel removed. The prop is stowed on the trailer inside one of the channel sections forming the main framework.

Braking Arrangements.

Although legally it is necessary only to provide an over-run braking mechanism on trailers weighing less than

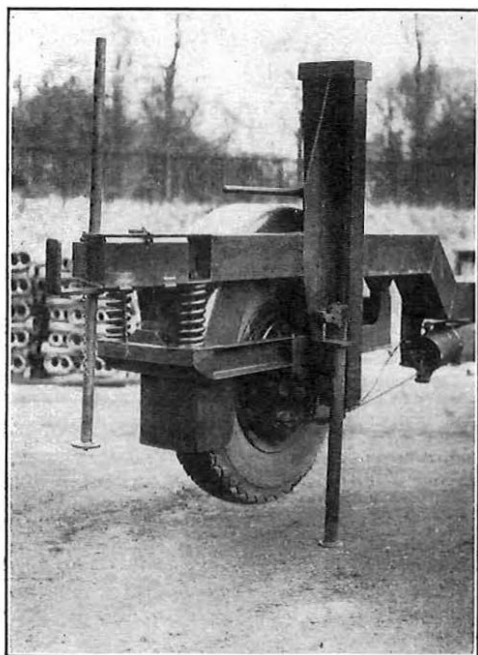

FIG. 3.—PROP FOR RAISING WHEEL.

20 cwt., it was considered wise to provide, in addition, vacuum-operated brakes for use when heavy drums, i.e., 3 tons or more, are to be carried. The larger vehicles capable of towing a gross trailed load of 4 tons or more are being equipped with vacuum-operated brakes, and by a simple extension of the pipe line on the vehicle it is possible to extend the system over a flexible connection to the trailer. The trailer braking cylinders then operate simultaneously with the vehicle brakes. Road tests showed that the over-run brakes alone were slightly more effective than the vacuum brakes alone (4.9 per cent. difference) whereas the combined effect of both brakes gave a maximum retardation and tended to skid the trailer wheels.

Other Facilities.

With the concentration of the load close to the road-wheel centres, the laden trailer is approaching a condition of balance. Actually, a downward load on the tow bar is required and is provided in order to obtain good vehicle-road-towing conditions. This condition, of approaching a balance, does however have a minor disadvantage; namely, that the centre of gravity of the drum may lie in a plane near to the plane of support given by the road wheels. This condition can arise only when the trailer is parked on a steep hill and a heavy drum is raised very high on the jacks. To prevent any tendency for the trailer to rock under this condition, and also to steady the trailer when cable is paid off the drum and men clamber about the trailer to rotate the drum, a pair of adjustable steady legs is provided on the rear ends of the main limbs (Fig. 1).

To meet legal requirements and prevent unauthorised persons releasing the brakes when the trailer is temporarily parked and unattended, a means of padlocking the parking brake in the "on" position is provided.

The front castor-wheel has been the subject of many changes during development. Originally the castor-wheel was raised only by a screw action but field conditions proved this to be very vulnerable to damage. The length of the exposed screw necessary to cater for various heights of vehicle towing bars prevented adequate support being provided and, although the castor wheel appeared at first sight to have been raised sufficiently to clear the ground by an adequate amount, at intersecting road cambers, ruts, pot holes, hump-backed bridges, etc., the clearance proved inadequate. The present method involves raising the castor-wheel a few inches by means of a screw action, and then unlatching the complete assembly and swinging it bodily forwards and upwards, securing it automatically in a position largely within the towing yoke and with a very considerable ground clearance, as shown in Fig. 2.

The detachable handle used for retracting the castor-wheel, and the tools for day-to-day maintenance, are accommodated in a tool-box formed by boxing-in a portion of the channel section limbs forming the main framework, as shown in Fig. 3.

CONCLUSION

The new trailer provides a compact lightweight means of transporting cable drums up to 7 ft. 6 in. in diameter and 3 ft. 8 in. wide and up to 4 tons in weight, with a minimum of ineffective time and labour in loading and unloading and a maximum of flexibility of use with a wide variety of towing vehicles. Cable drums exceeding these limits are sometimes encountered, but are rather exceptional and are outside the range of standard P.O. drums for which the trailer has been designed.

In conclusion, it is desired to express appreciation of the co-operation given in the development and production of these unorthodox trailers by the staff of Messrs. R. C. Gibbins & Co., Ltd.

Modernisation of Radio and Radar Equipment in H.M. Telegraph Ships

W. DOLMAN, M.Eng., and
P. W. J. GAMMON†

U.D.C. 621.396.932

The radio-communication and radio-navigation equipment in "Monarch," "Ariel," "Iris" and "Alert" has been replaced by more modern equipment, during the last two years, to meet the latest Safety of Life at Sea requirements, the provisions of the Atlantic City Radio Conference, and the requirements for efficient working by the ships. This article briefly describes the main installations and also mentions the broadcast rediffusion equipment recently provided.

INTRODUCTION

THE radio-communication and radio-navigation equipment in the Post Office cable ships has three main functions: aiding the safety of life and property at sea, both for the cable ship and for other nearby ships; communicating with the shore and with other ships, in connection with the ship's business; and assisting the safe navigation and speedy progress of the ship.

The technical requirements emanating from the international safety requirements¹ and the Atlantic City Radio Regulations² have been embodied in a series of marine radio performance specifications issued by the Post Office,³ which are used for the type-approval of commercial equipment. All the new equipment in the cable ships conforms to these standards.

The modernisation of the cable ships' radio equipment was begun in 1952 and has recently been completed. Work began on "Ariel" and continued on "Iris," "Alert" and "Monarch" as they became available for refit. The three smaller ships, "Ariel," "Iris" and "Alert," are treated together in the following descriptions because they are of much the same size, and do similar work.

RADIO-COMMUNICATION EQUIPMENT

"Ariel," "Iris" and "Alert."

The main channel for safety and ship's business communications uses a hand-keyed radio-telegraph transmitter operating on five "spot" frequencies in the 410-525 kc/s band, and a main ("general purpose") receiver. With this equipment reliable communication ranges up to some 400 miles over sea can be achieved in the absence of interference, and night-time ranges considerably in excess of this are common. Radio-telephone equipment is also provided and operates in the frequency band 1,600-3,800 kc/s, enabling the commander to speak directly to other nearby ships or, via the nearest coast radio station, to headquarters; it can also be used for personal calls by the ship's company. Reliable communication ranges up to 250-300 miles are achieved in the absence of interference, and at night calls to this country have been made from the Mediterranean.

An emergency, radio-telegraph, transmitter-receiver operating in the 490-510 kc/s frequency band is provided primarily for distress use. This equipment is fed from a battery of capacity sufficient to energise it continuously for at least six hours. It can also be used should the ship's main power supply fail or the main radio equipment be faulty—either occurrence is, however, rare in practice. Each ship has an automatic keying device,³ to key the main or emergency transmitter with the alarm signal or distress call. The emergency receiver, in addition to providing headphone reception over the 490-510 kc/s distress band,

has a loudspeaker watch facility.

The aerial rig on each ship is similar, except that "Alert" has a double "top" on her main aerial to compensate for her shorter mainmast, and more insulators, to maintain high leakage resistance in bad weather. The aerial rig, and the connections to equipment, on "Iris" are illustrated by Figs. 1 and 2. A feature of the aerial arrangement is the relatively large separation between the radio-telephone

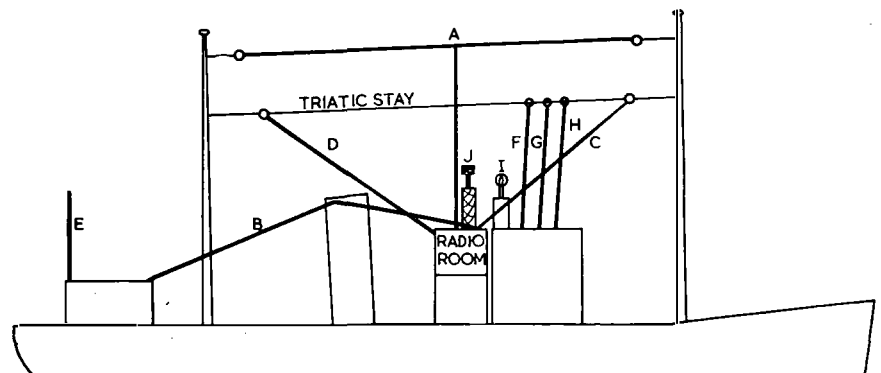

The aerials are: A—Main, B—Emergency, C—Radio-telephone transmit, D—Receiving, E—Radio-telephone receive, F—Broadcast, G—Direction-finder sense, H—Decca navigator, I—Direction-finder loops, J—Radar.

FIG. 1.—ARRANGEMENT OF AERIALS ON "IRIS."

transmitting and receiving aerials, which assists long-range duplex working; however, in practice, the present frequency assignments to the ships allow duplex working with reception on the main receiving aerial.

Only one radio officer is carried on these ships and he is normally on radio watch for a total of eight hours a day. For the remainder of the 24 hours an automatic watch over the 490-510 kc/s distress band is afforded by the

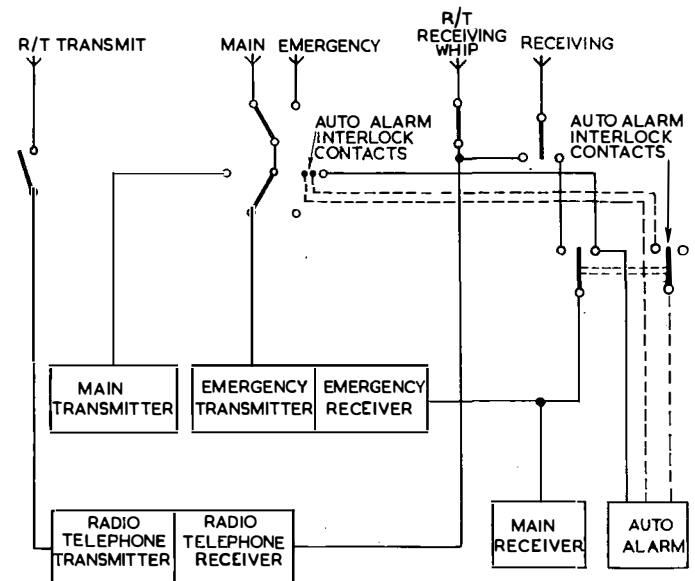

FIG. 2.—AERIAL CIRCUITS ON "IRIS."

† Mr. Dolman is an Executive Engineer, Radio Planning and Provision Branch, E.-in-C.'s Office, and Mr. Gammon was formerly an Assistant Engineer in the Branch.

¹ See end of article for numbered references.

"auto-alarm," a device that rings bells in the wheel-house, radio officer's cabin and radio room on the registration of the international alarm signal (a series of 12 consecutive dashes, each of 4 sec. duration and separated by 1 sec. intervals), sent to announce that a distress call or urgent cyclone warning is following. The auto-alarms in the cable ships are adjusted to ring the bells on the correct registration of four consecutive dashes of the alarm signal. This ensures a high probability of the correct receipt of the signal with a low probability of false calls being produced by a fortuitous combination of interfering signals. An arrangement of contacts on the aerial switches rings the alarm bells if the main aerial is not connected to the auto-alarm receiver when the latter is switched on. A self-contained signal generator is incorporated in the auto-alarm, for test purposes, and can be keyed manually or by the automatic keying device.

The main ("general-purpose") receiver in "Iris" is typical of modern marine practice: it covers almost all the frequency range 14-30,000 kc/s, with a choice of selectivity positions ranging from bandwidths of a few hundred cycles per second to several kilocycles per second. The automatic gain control can be switched on or off, and the radio-frequency and audio-frequency stages have separate manual gain controls. The beat-frequency oscillator has a fine frequency control and coarse and fine controls are provided for the main tuning, which has a long logging scale. Separate outputs for headphones or a loudspeaker and a built-in meter monitors currents at selected points in the circuit. A muting device permits "listening through" when the associated transmitter is keyed at speeds up to 40 words per minute.

"Ariel" and "Iris" are provided with prefabricated radio rooms, mounted abaft the captain's quarters—the old equipment had been housed in the radio officer's cabin. These rooms are made of riveted aluminium plate, heat insulation being provided by an air cavity between the plate and the (inner) wood walls. The floor is of bitumastic compound, surfaced with a cork-based floor covering. Both main and emergency lighting are fitted, the ship's mains put to the radio room being provided with suppressors to eliminate mains-borne interference. Intercommunication between the radio room, the wheel-house and the commander's day-room is by local-battery telephones.

In all three ships separate watertight compartments were built to house the rotary machines providing the special power supplies needed by the radio equipment; quiet radio rooms are thereby ensured.

The layout of a typical radio room is illustrated in Figs. 3 and 4: Fig. 3 shows the equipment layout plan and Fig. 4 is a view of the operating table of "Ariel."

The lifeboat portable radio equipments are designed to be used in distress by skilled or unskilled people and they are energised by built-in hand-driven generators. Type A2 (M.C.W.) emissions, automatically or manually keyed, can be made on 500 kc/s and 8,364 kc/s (a high frequency assigned for transmissions from survival craft), and a broad-band receiver, 490-510 kc/s, is included. The aerial comprises a collapsible rod which can be used to support additional aerial wire to increase the radiation efficiency. On 500 kc/s a power of about 2W is delivered to an average lifeboat aerial and, in the absence of interference, the transmissions can be picked up by other ships (or coast stations) about a hundred miles away. Under favourable conditions very much greater ranges are possible on 8,364 kc/s, via the ionosphere.

Radio-telephony is used between a ship and its boats; four V.H.F. "walkie-talkies" have been provided for each ship to meet this requirement. Amplitude modulation on a frequency of 156.3 Mc/s is used; only one control—the

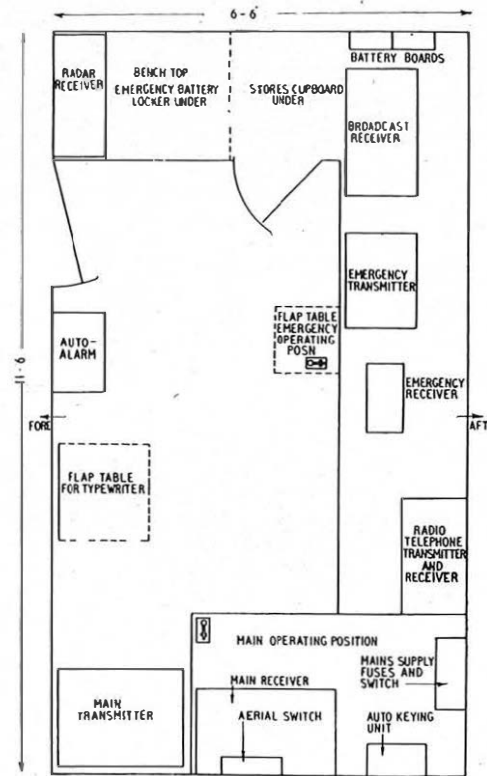

FIG. 3.—LAYOUT OF RADIO ROOM ON "ARIEL."

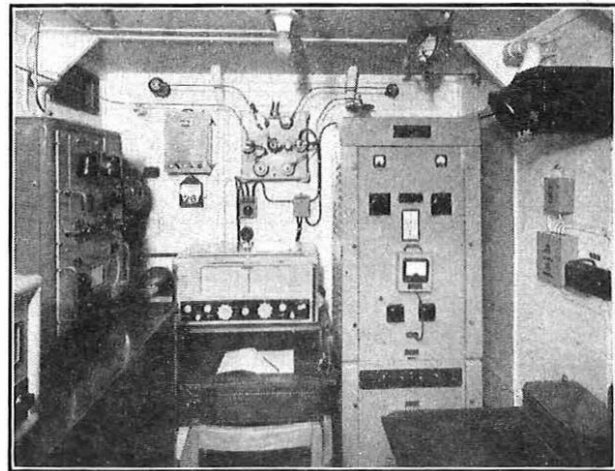

FIG. 4.—MAIN OPERATING POSITION ON "ARIEL."

"on/off" switch—is necessary, apart from the send/receive switch incorporated in the moulded handle of the handset. The total weight of the equipment is about 15 lb.

"Monarch."

The new radio-communication equipment in "Monarch" broadly resembles that in the other ships, with the addition of high-frequency (4-30 Mc/s) radio-telegraph and radio-telephone equipment.

Although not affected by the radio refit, "Monarch" has for some years carried a high-frequency single-side-band equipment made and installed by the Engineering Department⁴ for long-distance radio-telephony with the U.K. and the U.S.A.; the transmitter delivers 2 kW peak power to the aerial: this is the highest powered single-side-band transmitter so far used in a ship. Lifeboat portable sets are provided but no auto-alarm is necessary as three radio officers are carried and a 24-hour watch is kept.

The aerial arrangement on the ship is shown in Fig. 5;

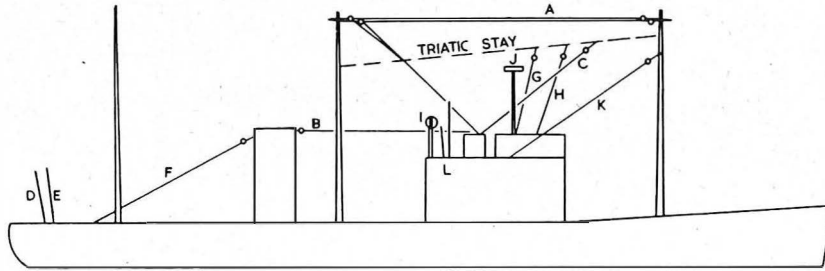

The aerials are: A—Main, B—Emergency, C—Radio-telephone transmit, D and E—Receiving whips, F—Broadcast, G—Direction-finder sense, H—Decca navigator, I—Direction-finder loop, J—Radar scanner, K—Loran, L—Transmitting whips.

FIG. 5.—ARRANGEMENT OF AERIALS ON "MONARCH."

the main aerial has a large electrical capacitance to increase the efficiency on medium-frequencies.

The main transmitter has five crystal-controlled frequencies in the 410-525 kc/s band and 18 in the 4-30 Mc/s band, and is arranged in two sections; the first section is a low-power (65W R.F. carrier output) transmitter, which can be used alone, and the second section a radio-frequency power amplifier which can be used to increase the output power to 300-500W, depending on frequency. Changeover from using the first section alone to using both is automatic, except for a simple manual change at the aerial board. Power reduction in the interests of reducing interference to other ships can be carried out quickly in approximately 6-db. steps, down to about 5W output. Either Type A1 (C.W.) or Type A2 waves can be emitted in the medium-frequency band, but Type A1 waves only are permissible in the high-frequency band.²

Reception is carried out on two adjacent receivers; one covers the frequency range 15-40 kc/s and 100-4,000 kc/s, and the other 250-520 kc/s and 1,400-25,000 kc/s. Their power units are in the main transmitter and an arrangement is included whereby, should the ship's main supply fail, a third power unit, energised from either of the duplicate emergency batteries, can be used to supply either of the receivers. These receivers can be connected to the main aerial, the emergency aerial or either of the 30-ft. whip receiving aerials mounted on the after end of the ship. Similar receivers are mounted on the opposite side of the radio room, and can be used in conjunction with adjacent medium-frequency transmitters, as reserves to the main receivers, or for the reception of several transmissions simultaneously.

A radio-telephone equipment is fitted which incorporates simplex (press-to-talk), voice-operated and duplex facilities. The transmitter is crystal-controlled on eight frequencies, in the band 1,600-3,800 kc/s including the radio-telephone distress and calling frequency of 2,182 kc/s, and the receiver can be used either on any of eight crystal-controlled frequencies, or continuously-tuned over the frequency ranges 150-350 kc/s and 490-3,700 kc/s. The radio-telephone circuit can be extended to the commander's day-room, drawing office and cable and power test rooms. The transmitting aerial is an inclined wire running to the triatic stay, and approaches quarter-wavelength at 3,800 kc/s; one of the after-end whip aerials is used for reception. The maximum unmodulated carrier power into the aerial is about 50W, and in the reduced-power position this falls to about 8W.

For safety purposes, the ship carries an emergency transmitter, emergency receiver and automatic keying device (in one unit) and three lifeboat portable radio equipments. Duplicate emergency batteries are also fitted, which can, when necessary, be connected in parallel to give a 24-V, 280-Ah. power supply, sufficient to energise the emergency equipment continuously for at least 12 hours.

Six V.H.F. "walkie-talkies" of the same type as on the

other ships have been provided.

The interior of the radio room is illustrated by Figs. 6 and 7.

RADIO-NAVIGATION EQUIPMENT

"Ariel," "Iris" and "Alert."

The radio-navigation equipments provided in "Ariel," "Iris" and "Alert" are: radar, radio direction-finder and Decca Navigator receiver.⁵ The Decca Navigator equipment was fitted in all the cable ships shortly after the inception of the system; it provides high-accuracy position-fixing in all weathers over a large part of north-west European waters and is used extensively for cable

work and ordinary navigation.

The war-time radars were replaced by modern commercial types of equipment in 1953. One major advantage of the new types is the centralisation of the controls for the equipment at the radar display unit in the wheel-house; another advantage is the larger size of display, 12 in.

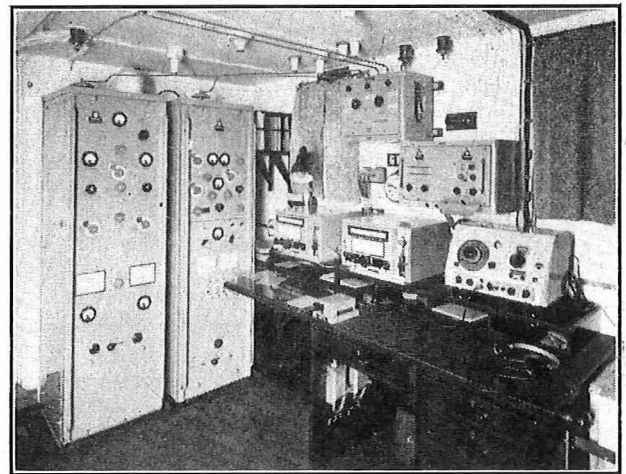

FIG. 6.—"MONARCH'S" RADIO ROOM—PORT SIDE.

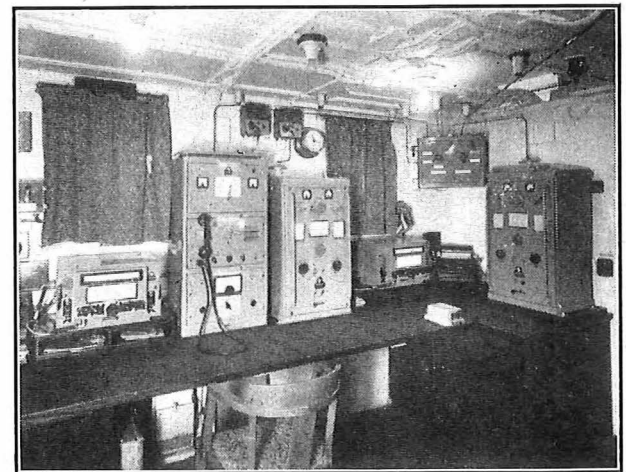

FIG. 7.—"MONARCH'S" RADIO ROOM—STARBOARD SIDE.

diameter. Objects of suitable size can be detected at ranges from 50 yards to 25 miles. "Iris" and "Alert" have a type of radar that uses wave-guide transmission to the scanner unit; "Ariel" (and "Monarch") have a type using a cable feed to the signal frequency unit mounted in the scanner unit. The former type has the advantage that maintenance work in an exposed position is likely to be less frequent; the latter type gives greater flexibility in siting the units comprising the equipment. Fig. 8 shows the

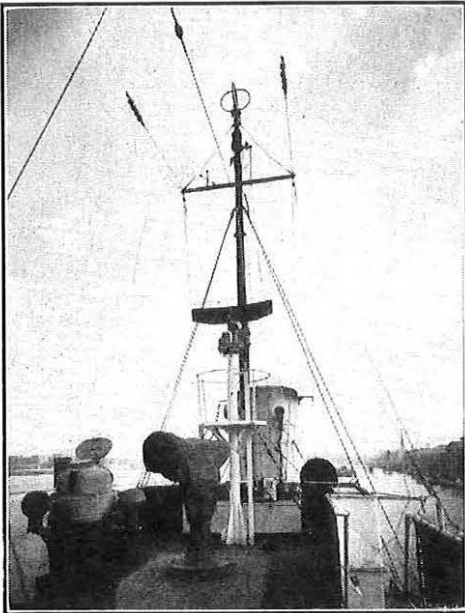

FIG. 8.—RADAR MAST AND SCANNER ON "ALERT."

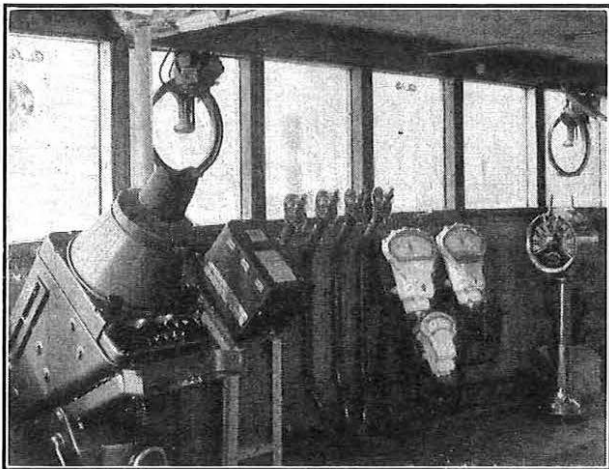

FIG. 9.—RADAR DISPLAY UNIT ON "ARIEL."

radar mast and scanner on "Alert" and Fig. 9 the display unit in "Ariel's" wheel-house.

The radio direction-finder (D.F.) is the oldest radio-navigational aid; and new direction-finders, of a modern type, have been fitted in all the cable ships. They are used in the frequency range 255-525 kc/s mainly for taking bearings on distress calls and on radio beacons, which are provided in all parts of the world. Marker buoys have been developed which carry C.W. transmitters operating in the 1,600-3,700 kc/s band and have a possible application as cable-locating buoys; the D.F. equipment also covers this frequency range. The direction-finder uses two fixed crossed loops, with a separate goniometer mounted with the receiver in an alcove in the chart-room. "Alert's" loop aerials can be seen on top of her mainmast in Fig. 8, and with such an arrangement the maximum calibration correction on 300 kc/s does not exceed 2°. It is of interest to note that on 300 kc/s the effective height of the loop aerial is only about two centimetres so that a field-strength of 50 μ V per metre produces an input signal of only 1 μ V across a matched load. A check on "Alert" showed that bearings with minima effectively no more than 1° wide could be obtained on a 365-kc/s radio beacon whose field-strength measured at the ship, was 40 μ V per metre.

Although no special receiver is required on the ship for the purpose, Consol Stations⁶ in Western Europe can be used for radio-navigation; longer range is obtainable than from marine radio beacons or the Decca system, but the lower accuracy is only sufficient for deep-sea navigation.

"Monarch."

"Monarch's" radio-navigation equipment is broadly similar to that in the smaller ships. The direction-finder receiver is in the radio room, however, and in addition, as an aid to her navigation on the western side of the Atlantic, a "Loran"⁷ receiver/indicator has been fitted in the chart-room. The receiver/indicator measures the difference in the time of arrival of pulses from two shore transmitting stations and this defines a hyperbolic position-line; measurement on another pair of stations gives another position-line, enabling the position of the ship to be determined.

BROADCAST REDIFFUSION EQUIPMENT

"Ariel" and "Alert" have each been fitted with a single-programme broadcast rediffusion system feeding 12 loudspeakers, each with its own volume control, and the receiver covers long, medium and high-frequency broadcast bands. "Iris," however, has been fitted with a two-programme system with nine loudspeakers each having its own switch/volume control.

"Monarch," in addition to having an audio-rediffusion system similar to that in "Iris," but with 15 loudspeakers connected and two headphone points in the ship's hospital, is provided with an aerial amplifier and distribution unit; this unit provides an efficient receiving aerial for 40 private receivers in the ship, and avoids the rigging of private aerials. "Monarch" also has two portable ships-main-operated electric gramophones with self-contained amplifiers and loudspeakers and three-speed turntables.

CONCLUSIONS

Cable ships generally have a special need for rapid and efficient radio-communication and for accurate radio-navigation, and this has been met in the P.O. cable ships by fitting the most up-to-date equipment available. The design and installation of ships' radio equipment are governed by the restricted space available, both for equipment and for aerials. This limitation precludes the achievement of a performance equalling that of land radio stations, but the new radio equipment of the P.O. cable ships should be well able to meet the demands made on it.

A liberal scale of spare parts has been provided, since the ships may at times be far from comprehensive maintenance facilities. Experience so far has shown that the reliability of the equipment provided is high, but in the event of failure alternative radio equipment ensures that a reserve channel of communication is available.

References.

- ¹ International Conference for the Safety of Life at Sea, London, 1948. Statutory Instrument, 1952, No. 1956. H.M.S.O. The Merchant Shipping (Radio) Rules, 1952. H.M.S.O.
- ² Statutory Instrument, 1952, No. 1957. H.M.S.O. The Merchant Shipping (Direction-Finders) Rules, 1952.
- ³ Radio Regulations, Atlantic City, 1947.
- ⁴ "Radio for Merchant Ships"; a series of G.P.O. Performance Specifications, issued between 1947 and 1952. H.M.S.O.
- ⁵ "Single-Sideband Multi-Channel Operation of Short-Wave Point-to-Point Radio Links: Part I, General Survey." W. J. Bray and D. W. Morris. P.O.E.E.J., Vol. 45, p. 97.
- ⁶ "The Decca Navigator System." *Engineering*, May 13th, 1949.
- ⁷ "The Consol Navigation System," A. H. Brown. J.I.E.E., Vol. 94, Pt. IIIA, No. 16, 1947, p. 968.
- ⁸ "Radar Navigation," R. A. Smith. J.I.E.E., Vol. 93, Pt. IIIA, No. 1, 1946, p. 335.

Some Principles of Anti-Side-Tone Telephone Circuits

H. J. C. SPENCER, A.M.I.E.E.†

U.D.C. 621.395.61:621.395.661

A simplified explanation is given of the basic anti-side-tone circuit employed in British Post Office telephones, and some of the factors influencing the design of telephones are discussed. Thus, this article serves as an introduction to a future article which will deal with the new 700-Type Telephone.

INTRODUCTION

G. A. CAMPBELL, in 1920, enumerated over half a million different anti-side-tone induction-coil circuits. For practical and economic reasons the number of these circuits suitable for use in British Post Office telephones is very limited and both the present standard transmission circuit, as used in Telephones No. 332, and a new transmission circuit used in the 700-type telephone, to be described in a future article, are based upon one particular Campbell circuit. This article summarises the important properties of the Campbell circuits and gives a simplified explanation of the way the circuit which forms the basis of British Post Office telephones works, assuming idealised conditions throughout. Some of the factors influencing the design of telephones based on this basic circuit are discussed and the relationship of the Telephone No. 332 circuit to it is shown. The fundamental equations for the idealised basic circuit are given in an Appendix.

FUNDAMENTAL PRINCIPLES OF CAMPBELL INDUCTION-COIL CIRCUITS

Campbell showed¹ that it was only possible for the transmitter, receiver and line of a telephone circuit to be interconnected so that each was matched to the remainder of the circuit, so ensuring maximum transfers of power, when an additional power-consuming impedance was included in the circuit. He showed that when these four impedances were interconnected so that each was matched to the remainder of the network, the power output of one of them, A, was shared between only two of the other impedances, B and C, with no power input to the fourth impedance D, while if the impedance D, to which there had been no input from A, had an output this would be shared between B and C with no input to A. He also showed that a similar conjugate relationship existed between B and C. In anti-side-tone telephone circuits the important facts are that when the transmitter, receiver, line and balance are interconnected by means of an induction coil so that each is matched to the remainder of the circuit, then

- the transmitter output is shared between the line and the balance with no input to the receiver, the desired no-side-tone condition, and
- the output from the line to the telephone is shared between the transmitter and the receiver with no input to the balance.

The lack of output from the receiver to the transmitter, and from the balance to the line, which also follow, are unimportant to the working of the telephone as these impedances do not normally have outputs. K. S. Johnson has shown² that although anti-side-tone circuits contain an additional power-consuming impedance they have the same theoretical efficiency as side-tone circuits, which do not include this additional impedance, because in the latter it is impossible to match all three impedances for maximum power output from, or input to, each.

† Executive Engineer, Subscribers' Apparatus and Miscellaneous Services Branch, E.-in-C.'s Office.

¹ Campbell, G. A. and Foster, R. M. Maximum Output Networks for Telephone Substation and Repeater Circuits. *Transactions of the A.I.E.E.*, Vol. XXXIX, 1920.

² Johnson, K. S. Transmission Circuits for Telephonic Communication (The Library Press, Ltd., 1924). p. 120.

THE BASIC CIRCUIT OF BRITISH POST OFFICE TELEPHONES

The basic circuit discussed is shown in Fig. 1, in which T, R and B represent the impedances of the transmitter, receiver and balance circuit of a telephone and L represents

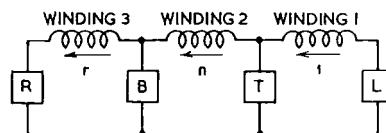

FIG. 1.—BASIC ANTI-SIDE-TONE TELEPHONE CIRCUIT.

the impedance of the line to which it is connected. These are interconnected by means of a three-winding induction coil of which the turns of windings 1, 2 and 3 are in the ratio $1:n:r$. The directions of the windings are such that if a changing flux in the core of the coil induces an E.M.F. in one winding in the direction of the arrow associated with it, then the E.M.F.s in the other windings will be in the directions of the arrows associated with them.

Throughout the explanation of how the basic circuit works it is assumed that:

- The induction coil is an ideal transformer, its windings having negligible resistance and leakage reactance and infinite self-impedance.
- The circuit is working in the condition that an E.M.F. in the transmitter causes no current to flow in the receiver, the no-side-tone condition.
- Where impedances are matched for maximum power transfers their reactive components are equal and of opposite sign.

The design of a telephone circuit is influenced by the following factors:—

- The types of exchange used by the British Post Office, and many other administrations, require that the signalling resistance of a telephone should be low, which means that the resistance of the transmitter must be much lower than the line impedance. Circuits based on the circuit of Fig. 1 are used in telephones in preference to others because they do enable a low-resistance transmitter to be used efficiently.
- Telephone circuits have to be designed to work efficiently in an existing line network, and when connected by it to older telephones.

The Basic Circuit Sending to Line.

The transmitter may be considered as an alternating E.M.F. in series with its impedance, which is almost pure resistance. This E.M.F. causes instantaneous currents i_1 and i_2 to flow in the circuit, as shown in Fig. 2. Current i_2 flowing in winding 2 has the greater ampere-turns product

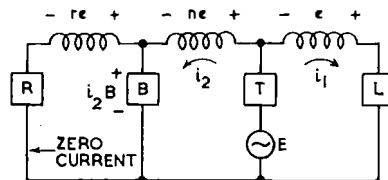

FIG. 2.—THE BASIC CIRCUIT SENDING TO LINE.

and determines the direction of the flux in the induction-coil core, hence the E.M.F.s e , ne and re induced in the windings are in the directions shown. Current i_2 flowing in B causes a back E.M.F. i_2B to appear across it and the value of r is chosen so that, with the values of B and n determined as described later:

$$re = i_2B$$

The E.M.F. applied to the receiver is the sum of re and i_2B and as they are equal and are opposed no current flows in the receiver, the no-side-tone condition.

Examination of the equation for the impedance to which the transmitter is connected, assuming side-tone balance,

shows that the circuit is effectively that shown in Fig. 3. For maximum transmitter output the impedance of this circuit should match the impedance of the transmitter and it can be made to do so by variations of n and B . Variations of n and B also vary the ratio in which the output of the transmitter is used in the line and wasted in the balance. This ratio is sometimes termed the Y ratio of the circuit

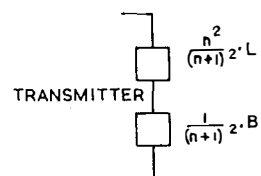

FIG. 3.—IMPEDANCE TO WHICH TRANSMITTER IS CONNECTED.

and the greater it is, the greater is the sending efficiency, but the lower is the receiving efficiency, as explained later. The values of n and B are chosen therefore to simultaneously match the transmitter to its load and to give the required Y ratio.

The Basic Circuit Receiving from Line.

The input from the line can be considered as caused by an alternating E.M.F. in series with its impedance and this causes instantaneous currents i_3 and i_4 to flow in the circuit, as shown in Fig. 4. Current i_3 flowing in winding L

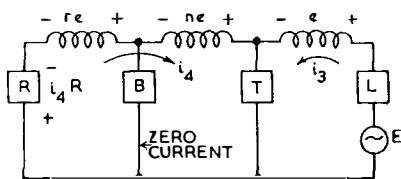

FIG. 4.—THE BASIC CIRCUIT RECEIVING FROM LINE.

has the greater ampere-turns product and determines the direction of the flux in the induction-coil core, and the E.M.F.s e , ne and re induced in the windings are in the directions shown. Current i_4 flowing in R causes a back E.M.F. to appear across it and the value of R is chosen so that (with the values of B , n and r chosen to give no side-tone, to match the transmitter to its load, and to give the required Y ratio),

$$i_4R = re$$

(The impedance of any physical design of receiver may be varied in magnitude, but not in angle, to suit circuit requirements by varying the gauge of wire and the number of turns of its winding.) The E.M.F. applied to B is equal to the sum of i_4R and re , and as they are in opposite directions and are equal, no current flows in the balance as a result of the E.M.F. in the line.

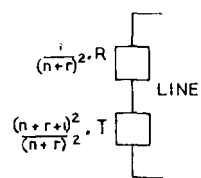

FIG. 5.—IMPEDANCE OF TELEPHONE CIRCUIT, AS SEEN FROM THE LINE.

The equation for the impedance of the telephone circuit viewed from the line terminals shows, when the value of R has been chosen to give no current in B when receiving, that the circuit is effectively that shown in Fig. 5. It is a property of the basic circuit that when n , r and R have been chosen in the ways described the impedance of the telephone circuit for receiving matches the line, so ensuring the maximum

transfer of power from the line to the telephone.

It will be seen from Fig. 5 that the power received by the telephone from the line is shared between the receiver, used power, and the transmitter, wasted power. It is another property of this circuit that in the no-side-tone condition, and with no received power dissipated in the balance, the ratio:

$$\frac{\text{Received power wasted in the transmitter}}{\text{Received power used in the receiver}}$$

is the same as the ratio:

$$\frac{\text{Transmitter power sent to line}}{\text{Transmitter power wasted in the balance}}$$

previously referred to as the Y ratio.

The Balancing of Sending and Receiving Efficiencies.

From the foregoing, it will be seen that values of Y greater than 1 increase the sending efficiency of a telephone circuit at the expense of the receiving efficiency, while values of Y less than 1 do the reverse. The relationships between the Y ratio and the sending and receiving efficiencies of a perfect telephone are shown in Fig. 6, and Fig. 7 shows

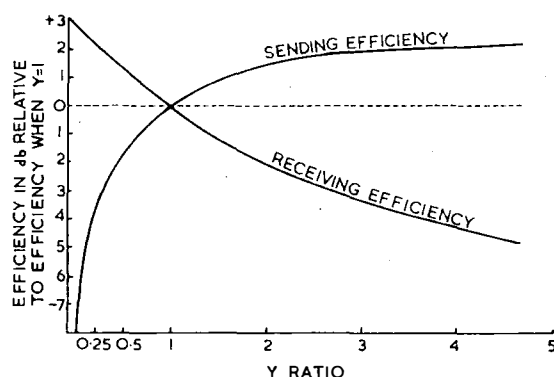

FIG. 6.—SENDING AND RECEIVING EFFICIENCIES OF A PERFECT TELEPHONE.

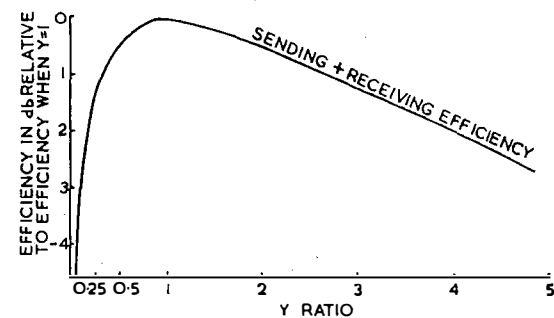

FIG. 7.—OVERALL EFFICIENCY OF A PERFECT TELEPHONE.

how the sum of the sending and receiving efficiencies, the overall efficiency of the telephone, varies with Y . Fig. 7 shows that the maximum overall efficiency is obtained when $Y = 1$, and if a telephone was designed for use only with telephones of its own type this ratio would be used.

A new telephone can, however, only be introduced into a system gradually and for many years it has to work with older telephones. To enable economic advantages to be obtained from any improved performance it is necessary for the new telephone to be used on longer lines. To do this when working to older telephones when, as in the British Post Office system, transmission limits are determined by the direction of worst transmission, it is necessary for the new telephone to have both transmitting and receiving performances superior to the older telephones. If the improved performance of the new telephone springs from either a transmitter with greater output or a more sensitive receiver, but not both, transmission in only one

direction will be improved. In these circumstances the Y ratio can be changed so that the improved transmitter or receiver results in a balanced increase of sending and receiving efficiencies. From Figs. 6 and 7 it will be seen that values of Y departing far from 1, while improving one efficiency give a disproportionate decrease in the other. For example, if the Y ratio is increased from 1 to 5, sending efficiency increases by approximately 2.2 db while receiving efficiency decreases by 4.8 db. For this reason the values of Y used are usually near 1.

The Addition of a D.C. Blocking Capacitor.

For practical telephones an essential modification to the circuit of Fig. 1 is the provision of a capacitor in the position shown in Fig. 8. The main purpose of this

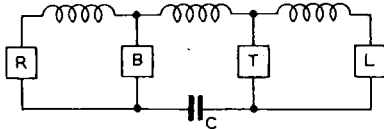

FIG. 8.—ADDITION OF A D.C. BLOCKING CAPACITOR.

capacitor is to force all the line D.C. current to flow through the transmitter. This is essential when high sending efficiency is required because the A.C. output of a carbon-granule transmitter increases with the increase of D.C. current flowing in it. A subsidiary function which the capacitor performs is to prevent polarising D.C. currents from flowing through the receiver, as these would aid or oppose, depending upon their direction, the flux in the receiver due to its permanent magnet. Increased or decreased flux are equally undesirable because the magnet flux is adjusted during manufacture to the optimum value and any departure from this reduces the receiver sensitivity. In British Post Office telephones the same capacitor also performs two auxiliary signalling functions. When the telephone is not in use on a call the capacitor is connected in series with the bell across the line, blocking the exchange D.C. signalling E.M.F. but allowing an A.C. calling current to ring the bell. During dialling the capacitor forms part of the spark quench for the dial pulsing contacts. The impedance of the capacitor, the value of which is usually about $2\mu\text{F}$, is low at speech frequencies and its presence may be ignored at all but the lowest. The use of larger values of capacitance, although desirable, is ruled out because of size and cost.

DEPARTURES OF PRACTICAL TELEPHONE CIRCUITS FROM THE IDEAL

The conditions which, in order to simplify the explanation of how the circuit works, were earlier assumed to be met are of course unattainable in practice. In particular the balanced no-side-tone condition is achieved but rarely. For no side-tone it is necessary for the impedances of the balance circuit and the line to have a fixed relationship, depending upon the turns ratio of the induction coil, and this relationship must hold at all speech frequencies. It would be possible to design a balance circuit which would achieve this for a particular line with a particular terminating condition but practical telephones are not made to suit individual lines and the terminating conditions of the lines they are used on vary from call to call. The maintenance of good side-tone suppression at the lower speech frequencies is particularly difficult. The impedance of a line is of the type shown in Fig. 9(a), the resistance path being completed in the exchange apparatus via the central battery and the capacity being the wire-to-wire capacity. The impedance of the balance of a telephone using a D.C. blocking capacitor is, if the frequency is too low for the impedance of the capacitor to be ignored, of

the type shown in Fig. 9(b). As the frequency falls the impedance of the circuit of Fig. 9(a) approaches R_L while the impedance of Fig. 9(b) approaches infinity. The two impedances will thus diverge widely, the frequency at which the divergence becomes important depending on the value of C_B .

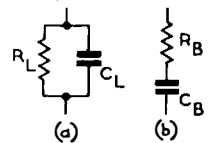

(a) Line Impedance.
(b) Balance Impedance.
FIG. 9.—TYPE OF LINE AND BALANCE IMPEDANCES.

The problem in the design of a practical telephone circuit becomes therefore not a question of achieving side-tone balance at a particular frequency for a rigid set of line conditions, but of keeping the side-tone low over the important part of the frequency band for the range of line conditions which will be met in service.

The Present Standard British Post Office Telephone Circuit.

The present standard British Post Office telephone circuit is typified by Telephone No. 332, the circuit of which is shown in Fig. 10. To show the relationship between this circuit and the basic circuit which has been discussed it is necessary to rearrange it. If, in a circuit, elements are in series their order may be interchanged without in any way affecting the working of the circuit. Making use of this fact the part of the circuit of Fig. 10 enclosed by dotted lines may be interchanged with winding 2 of the induction coil, with which it is in series, to give the circuit of Fig. 11. Similarly the order of winding 3 and the receiver may be reversed and, if this is done, the circuit may be re-drawn as shown in Fig. 12, in which irrelevant signalling contacts have been omitted. The circuit of Fig. 12 is exactly equivalent to that of Fig. 10 for transmission purposes, the arrangement of Fig. 10 being adopted for the practical telephone because it allows the use of a 3-way handset cord in place of the 4-way cord needed by the circuit of Fig. 12.

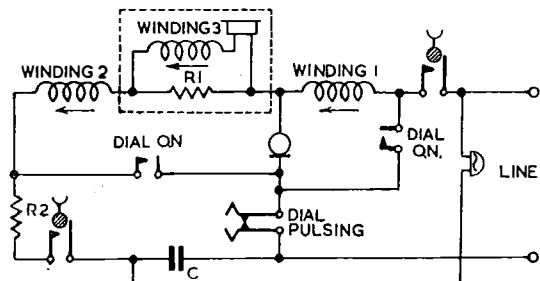

FIG. 10.—CIRCUIT OF TELEPHONE NO. 332.

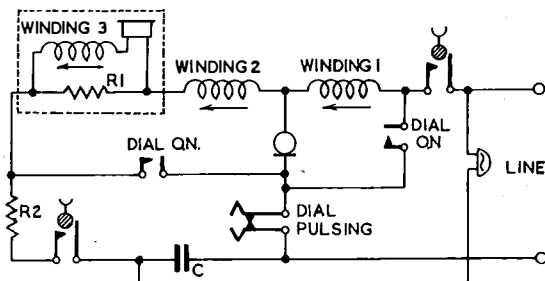

FIG. 11.—REARRANGED CIRCUIT OF TELEPHONE NO. 332.

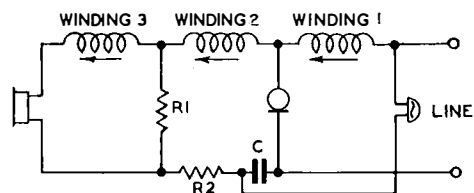

FIG. 12.—BASIC TRANSMISSION CIRCUIT OF TELEPHONE NO. 332.

Comparison of Fig. 1, the basic circuit, and Fig. 12, the Telephone No. 332 circuit, reveals their similarity. The circuits differ due to the inclusion in the 332 circuit of a D.C. blocking capacitor, the need for and effect of which have already been discussed, a bell and the resistor R2. The impedance of the bell to speech frequencies is so high that its presence may be ignored. The resistor R2, which is included as a separate component to form part of the dial spark quench, does not fundamentally affect the method of working described for the basic circuit but it does require different proportioning of the circuit constants and results in a slight loss of receiving efficiency.

When the 332 circuit is sending to line the no-side-tone condition is achieved by choosing the ratio r so that the E.M.F. induced in winding 3 is equal to and opposes the back E.M.F. in R1 in the receiver circuit. With no current flowing in the receiver due to the transmitter E.M.F., the effective part of the circuit to be considered during sending is that shown in full lines in Fig. 13. In this, it is resistors

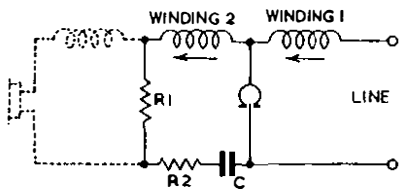

FIG. 13.—SENDING CIRCUIT OF TELEPHONE NO. 332.

R1 and R2 in series which correspond to the balance of the basic circuit and it is their combined value which, in conjunction with the ratio n of the induction coil, determines the ratio of transmitter power sent to line to power lost in the balance, the Y ratio. With R1 and R2 chosen so that their sum, together with the value of n , gives the required Y ratio and matches the transmitter to its load, the presence of R2 does not involve any loss of sending efficiency compared with the basic circuit.

When the Telephone No. 332 circuit is receiving from line, with the circuit balanced for no side-tone when sending, no current flows in the balance (R1). This is because the E.M.F. induced in winding 3 and the back E.M.F. in the receiver are equal and are applied to R1 in

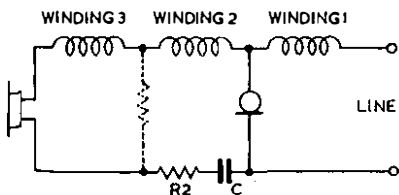

FIG. 14.—RECEIVING CIRCUIT OF TELEPHONE NO. 332.

Book Review

"Magnetic Amplifiers." Dr. H. F. Storm. Chapman & Hall, Ltd. 545 pp. 368 ill. 108s.

The price of this book puts it in the class that is purchased only by the specialist and by libraries. Its subject is static magnetic amplifiers of the type employing saturable reactors. It is an addition to the series now numbering about ten books written by the staff of the General Electric Company of America. Nine authors have contributed to it and Dr. Storm has linked the contributions into an effective whole. The thoroughness of treatment and the authority cannot be questioned.

The first 30 pages deal with the theory of magnetism and the modern theory, evolved about twenty years ago, is well covered. Magnetic materials and their testing, magnetic amplifiers under steady-state conditions, the transient response, and

opposition. The effective part of the circuit, if no current flows in R1, is that shown by full lines in Fig. 14. The resistor R2 is in series with the receiver and as a result the power received from the line, which in the basic circuit is shared between the transmitter and the receiver in the Y ratio, in this circuit is split between the transmitter and the combination of the receiver and R2. The power which, in the basic circuit, went to the receiver only is therefore further sub-divided between the receiver and R2 and the circuit is less efficient than the basic circuit for this reason, but as the ratio of R2 to the receiver impedance is low the loss of receiving efficiency is very small.

All practical versions of the basic circuit have, in the inevitable resistance of winding 2, a resistance equivalent to R2, but as it is not present as a separate component it is apt to be lost sight of. By interchange of series components, R2 in the Telephone No. 332 circuit could be made to appear adjacent to winding 2 and could be "hidden" in it, although it could then no longer perform its spark quench function. It does however represent an increase over the unavoidable resistance of winding 2 and means that the transmission performance of the circuit is slightly degraded to enable the one capacitor to be used for transmission purposes and as a spark quench, with resulting economy.

APPENDIX

The Fundamental Equations for the Basic Anti-Side-Tone Circuit Used by the British Post Office.

The symbols T , R , L and B are used throughout (in place of Z_T , etc., for the sake of clarity) to represent the impedance of the transmitter, receiver, line and balance respectively:—

1. For maximum output from the transmitter:

$$T = \frac{n^2 L + B}{(n + 1)^2}$$

2. For maximum output from the line:

$$L = \frac{R + T(n + r + 1)^2}{(n + r)^2}$$

3. For no side-tone:

$$B = \frac{n r}{n + r + 1} \cdot L$$

4. For a required power ratio Y :

$$Y = \frac{n^2 L}{B}$$

The values of T , L and Y are fixed by considerations outside the control of the circuit designer, thus the above four equations are sufficient to fix the variables n , r , B and R .

5. For no power loss in the balance when receiving:

$$R = T \cdot \frac{r}{n} (n + r + 1)$$

This is not an independent equation and it may be derived from the first four equations.

feed-back are fully treated in some 280 pages. The construction of saturable reactors and practical considerations are also covered. There is a useful chapter on metal rectifiers, including a brief reference to the germanium and silicon types. The last 100 pages cover applications of saturable reactors. There is an extensive and up-to-date bibliography.

The diagrams are well drawn, little space is given to photographs and, as would be expected, the production is excellent. To the designer of magnetic amplifiers the book would be invaluable, and anyone who is concerned with magnetic circuits will find much useful information.

The treatment is of necessity mathematical but the contributors have succeeded in making the book appeal to those who, while not mathematically inclined, would like to know more about magnetic amplifiers.

A. E. P.

"Mosaic"—An Electronic Digital Computer

A. W. M. COOMBS, Ph.D., B.Sc., A.R.T.C.†

Part 3(a).—The Art of Programming

U.D.C. 518.5:681.142

Parts 1 and 2 of this article have considered the separate functions of the four main sections of the computer "Mosaic"; it will be the aim of Part 3 to combine the sections and give an overall picture of the machine in operation, with particular reference to the art of programming. Part 3(a) deals with the machine as a whole and Part 3(b) will deal with programming in general and will give examples of programming for particular problems. Diagrams will still be schematic, for it will be in Part 4 only that the major problem of translating the theoretical ideal machine into practical circuitry will be considered.

THE MACHINE AS A WHOLE

It was explained in Parts 1 and 2 that the main sections of Mosaic (as of all other digital computers) are the Store, the Arithmetic Unit, the Control Unit and the Input-Output mechanism. To recapitulate, their individual functions may be summarised as follows:—

1. *The Store* contains input numbers, instruction words and interim results.
2. *The Arithmetic Unit* adds, subtracts, multiplies, delays and compares selected numbers A and B from the store to give numbers C.
3. *The Control Unit* interprets instructions and sends corresponding signals to various switching circuits to govern the arithmetical or other transfer processes taking place. This unit also controls the flow of instructions to itself after the initial manual instruction.
4. *The Input-Output Mechanism* provides access for the machine controller to the machine, and a means of recording final results.

Fig. 9 illustrates in the simplest possible way the interconnections necessary to provide the complete machine.

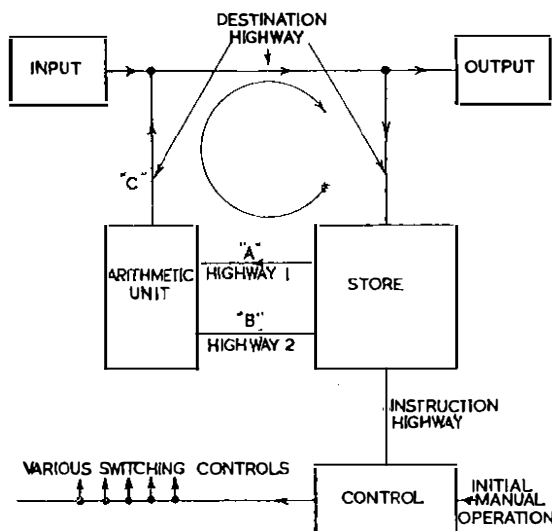

FIG. 9.—SIMPLIFIED BLOCK SCHEMATIC DIAGRAM OF MOSAIC.

The diagram is inaccurate in detail, but it does give a true overall picture. The course of a single computation will be, in general, that numbers are first fed into the store from the Input, that a series of arithmetical operations then takes place, each following the track of the circular arrow—that is, various numbers A and B will be combined to give various numbers C—and finally, that the results are fed to the Output. The selection of A and B, the selection of the way of combining A and B, the selection of the time of transfer and of the destination for C, are in all cases carried out by the Control Unit, which also, and simultaneously, selects the next instruction it will obey. The first instruction requires to be inserted by hand, since, at the commencement of a calculation, the store is empty (or possibly filled with

irrelevant information); it will consist of an instruction to feed data from the Input to the machine, as will be seen later.

A more detailed diagram of the computer is given in Fig. 10, and this diagram will be the basis of further discussion. Even Fig. 10 does not purport to be a full logical representation of the machine; where possible, standard logical symbols have been used, but where the switching process is more complex, the various switches are represented by simple rectangles, sometimes including a "relay" contact, and sometimes left blank for their functions to be discussed subsequently. Control leads are easily distinguishable from data leads since they are all labelled with their points of origin in the control circuit. The object of these conventions in Fig. 10 is to avoid complicating the diagram with too much minute detail, and thereby obscuring the essential simplicity of the whole switching system. For the same reason, some slight inaccuracies have been introduced which will not vitiate the general argument.

The Highways.

The interconnecting members for data in dynamic form undergoing transfer between the four main sections of the computer are the four "Highways." The seven-digit numbers "Source 1" and "Source 2" of the staticised instruction word in the Control circuit set up switching "Trees" which enable Highway 1 and Highway 2 respectively to be connected temporarily to any delay line in the store; the Trees are not shown in the main diagram, Fig. 10, but a typical miniature Tree to differentiate between four sources using two binary digits is illustrated at the bottom left-hand corner of Fig. 10. The numbers in the two highways are fed to the Arithmetic Unit, where they are combined according to the four-digit "Function" word in the current instruction.

The "Destination Highway" carries numbers which are to be fed into the store. It is supplied by the Arithmetic Unit, and is able to select the proper delay line destination by virtue of a third switching Tree controlled this time by the 7 "Destination" digits in the current instruction. This is the general rule; exceptionally, the destination highway can feed to the Output, the Discriminator and the Control Unit, and it can also receive signals (under the control of "Source 1, ID") from the Input.

The five-digit number "N.I.S." in the current instruction word sets up a fourth switching Tree which serves to connect any one of the 32 lines in the store which may contain instructions, to the fourth or "Instruction" highway. In normal course, this highway connects to "INST" and thence to the Control Unit; exceptionally, the connection to INST may be broken, in which event INST is connected to Destination Highway instead. This is a part of the "Start" routine, which has yet to be described.

It will be observed that the function-box unit forms as it were an alternative recirculation path for any delay line in the entire store. It follows that the time taken by a

† Principal Scientific Officer, Post Office Research Station.

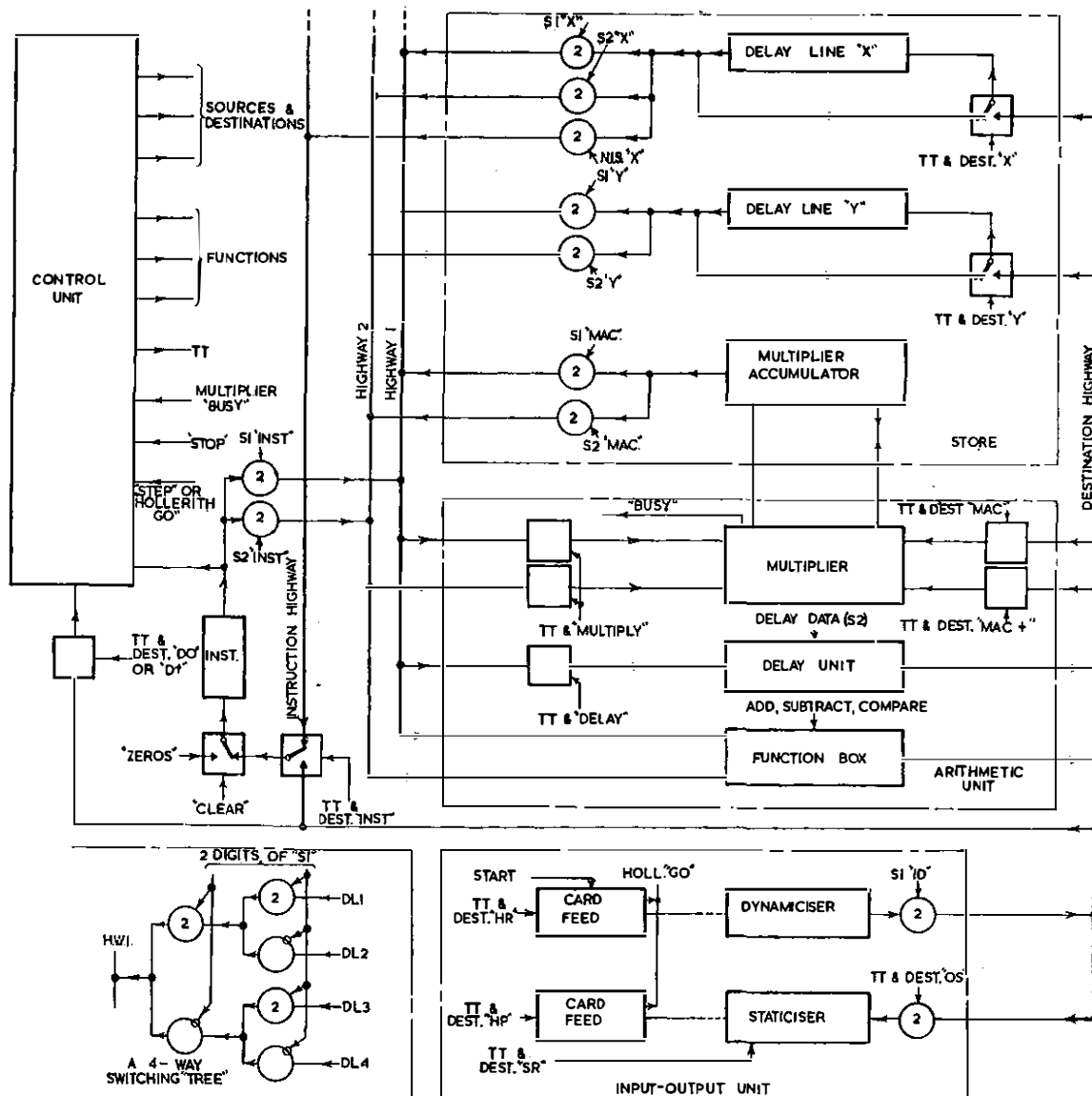

FIG. 10.—DETAILED BLOCK SCHEMATIC DIAGRAM OF MOSAIC.

pulse to travel through the Trees, along the highways and through the various switching stages of the function box must be exactly the same as the local recirculation time. Ideally, both times are infinitely short; in practice the function-box path is much the longer, and this fact has a very important bearing on the electronic switching technique, as will be shown in Part 4. For the moment, ideal conditions will be assumed, with both routes infinitely fast. Fig. 10 shows two typical storage lines: "X", which can contain numbers or instructions, and "Y", which is available directly only for numbers.

Special Sources and Destinations.

The three Trees "Source 1," "Source 2" and "Destination," being each under the control of 7 digits, should each be capable of establishing 2^7 or 128 possible connections. There are not more than 100 lines in the store (actually rather less), so that at least 28 Sources and Destinations are available for other uses. Some of these have already been specified—such as destinations "D NOUGHT" and "D PLUS" for the discriminator control, and source "Input Dynamiciser" for connecting the input to destination highway. Others are used for various special purposes. Thus source "107" is a number consisting of 1's in all 40

digital positions (equal to -1 in the machine convention), which can be supplied to Highways 1 and 2 by specifying that source number in the instruction word. Similarly, a "P1" (1 in the least significant digit position followed by 39 zeros, equal to -1 as a binary number) is available as Source "97," and "P2" (1 in the second least significant digit position preceded by zero and followed by 38 zeros, equal to $+2$ as a binary number) is provided by source "98." Several other convenient combinations of digits, which need not be specified, are also available. Except for source "ID," the Input-Output control is governed by destination addresses, as has already been explained (Part 2). Destination "INST," which as a binary number is "0000000," is of great importance; it connects Destination Highway to the Control Unit (via INST) and over-rides Instruction Highway in so doing. Finally, some sources and destinations remain as "spare"; they operate no gates and control no switches, and even in this negative aspect have their uses.

All sources are "tapping" points—that is to say, they can extract information without interfering with the orderly circulation of that information or destroying it. It is different for the destinations. If a number is to go into a certain part of a line it follows that the previous number

occupying that position must be deleted. Therefore, while a Source Tree connection may be established at any time (although of course it must not be changed during a transfer) a Destination Tree connection may be prepared in advance, but must not be finally established until the actual time of transfer. For this reason, all the destination switches are composite affairs requiring the simultaneous "ON" condition of both the address number and the TT trigger in the control circuit. Even for those addresses not concerned with circulation in the store this is true. For instance, "Hollerith Read" might appear as an ephemeral condition during the setting up of an entirely different destination address, and would have the effect of starting the Hollerith Reader if allowed to be effective. Therefore, the whole address must be set up before it is read, and TT provides the reading signal.

Arithmetic Unit Facilities.

A binary number 40 digits long can in the first instance represent any one of 2^{40} numbers, including zero. By the convention of the machine, half of these are regarded as negative. Assuming that there is no "binary point" complication—that is, that a 1 in the least significant digit position represents the value 1 numerically—then all numbers up to $(2^{39}-1)$, which is 39×1 s plus a zero in the 40th position, are positive. Any number a of higher value is interpreted as a negative number equal in magnitude to $(2^{40}-a)$, and is of course characterised by the presence of a 1 in the most significant digit position. The range of numbers represented is thus from (-2^{39}) through zero to $(+2^{39}-1)$. Another way of regarding the convention is to say that the first 39 digits always represent a positive number in normal binary form, but that the numerical value represented by the 40th digit is to be subtracted to give the true number. The technique is in fact the same as that used for representing negative logarithms in normal calculations, and is adopted for the same reason—it makes the common operation of addition and subtraction very easy. The basic idea can easily be extended to the case where a binary point exists in the number, or where the number, being the result of a multiplication, possesses 80 digits.

In some problems, the possibility of negative numbers does not arise, and the 40 digits can then be used to represent 2^{40} positive numbers, in the normal way. Multiplication of two numbers follows different rules under the two conventions, and accordingly, when a multiplication is called for, it must also be specified whether the members are to be regarded as "signed" or "unsigned." Addition and subtraction may require suppression of the "carry" digit after the 40th digit, after the 80th digit (double-length arithmetic) or not at all, and this facility involves four possible function instructions for each. Adding the two forms of multiplication, the three forms of comparison ("and", "or" and "not equivalent to") and the delay function, gives 14 possible operations the four function digits may call for. There are thus two spare functions (0100 and 0000) both of which cut off all output from the Arithmetic Unit to Destination Highway, and the second of these—0000—is required for the "Starting" programme.

The "multiplier accumulator" is in effect a delay line 80 digits long with its local recirculation path through the multiplier. It "collects" the answer to a multiplication, which may be up to 80 digits long as already mentioned, and circulates it until a later instruction calls for it by specifying "MAC" (that is, No. 95) as Source 1 or 2. It can also be used as an 80-digit store by feeding to Destination "MAC" (No. 95). If Destination "MAC+" is specified (No. 94), then the number on Destination Highway is added to whatever is already in the accumulator.

When a multiplication is called for, no destination is

required, as is obvious from Fig. 10. However, the seven-digit "Destination Address" in the instruction word must be filled in, and if any working address were specified, the circulation of that part of the store would be interrupted during the transfer. Therefore, an unwired or ineffective address is used—usually "1110000" or "112."

The "delay unit" can delay signals by any amount up to 47 pulse periods, and requires six digits to do so. There are not sufficient spare digits in the instruction word to provide this in addition to all the other facilities required, so the digits of "SOURCE 2" are pressed into service for the purpose. These digits cannot of course be used for "Tree" control and "Delay" control simultaneously, so only Highway 1 is fed to the delay unit. If a delay function is called for, Source 2 Tree is set up as for a normal instruction, and an irrelevant stream of signals will flow along Highway 2 to the function box—but the function box is disconnected from Destination Highway if delay is specified, so no harm results. Similarly, the delay unit output is cut off if any other function is specified. A TT control has to be provided at the input to the delay unit to ensure that no spurious pulses are fed into it due to an adventitious "DELAY" instruction occurring during the "SET-UP" beat.

Miscellaneous Facilities.

The Input-Output gear has the controls already indicated (Part 2) and illustrated in Fig. 10. In addition, there is a "Start" button associated with the Hollerith Reader, which starts a card feed. The opposite throw of the stop key is called the "Clear." It interrupts the circuit feeding INST and causes zeros only to flow by this route into Control. These two facilities are required for the starting programme.

Typical transfer operations in a programme would be as follows:—

1. Take two numbers from the store, add them, and put the answer back in the store.
2. Take one number from the store, delay it, and put it back in delayed form into the store.
3. Take one number from the Input Dynamiciser, and put it in the store.
4. Take two numbers from the store, subtract one from the other, and feed the answer to "D+." (This alters the length of the "Obey" beat if the answer is negative.)
5. Take two numbers from the store and multiply them, taking account of sign. Destination 112 to be specified.

It is all very simple in principle. But there is one particular difficulty—how does anything take place before any instructions have been stored? This is the problem of starting, and it will now be treated.

THE STARTING PROGRAMME

The important factors at starting are the key "Clear," the two push-buttons "Step" and "Start," and the three addresses "Source Input Dynamiciser," "Destination INST" and "Next Instruction Source 0." The last has not yet been mentioned, so a word or two of explanation is necessary.

There is no fundamental reason why any one delay line should have the same address relative to the four different Switching Trees, but it is a great convenience in programming and maintenance. In general, therefore, the number of a line in the store, and the address which finds it in any Tree are the same, with a single exception. Delay line No. 0 is a long line not used for storage at all, but associated with the circuits for adjusting frequency to temperature, which will be dealt with in Part 4. Source 1 "0" is the Input Dynamiciser, Source 2 "0" is a source of zeros only, Destination "0" is that destination which is also called "INST," and Next Instruction Source "0" is a short line

(TS0) which is No. 64 for all other purposes. The line TS0 is the only short line of the 32 lines available for instruction storage.

The real problem of starting is to get the first instruction word from Input to Control. Once there, that word itself can start the next transfer and so eventually get the whole instruction programme and all the numerical data into the machine. Now there is one instruction word which is easy to set up on the current instruction staticiser by artificial means, and that is a word consisting of 40 zeros. This word is not meaningless, but has a very definite significance. It is an instruction which orders the following operation:—

Connect Source 1 "0" (dynamiciser) to Destination Highway, and connect Destination Highway to destination "0" (INST), thereby cutting off Instruction Highway from Control. Cut off all output from the Arithmetic Unit to Destination Highway (function "0"). Perform this transfer immediately (characteristic "0") for one minor cycle (timing number "0")—or, more accurately, perform it after an integral number of major cycles have followed the end of the "Set-up" beat, pending external authorisation (Go digit "0").

The instruction will also, and irrelevantly, feed zeros to Highways 1 and 2 (which are "stumped" at the Arithmetic Unit) and connect TS0 to Instruction Highway (which is "stumped" at the "DEST INST" switch, as shown in Fig. 10). This instruction is the one desired, since it connects input to control, and prevents all other transfer.

The general principle of the starting routine is as follows. There are three fundamentally different types of instruction words. Those of the first type are concerned with getting the machine prepared in the sense of ensuring that the multiplier is empty and the output staticiser reset, and of establishing which minor cycles are "odd" and which "even" (essential for the multiplier). These are fed directly from Input to Control using the 40-zero instruction—they never enter the store at all, and once used are therefore lost. The instructions of the second type are to be used for controlling directly or indirectly the feed-in of the true computational programme and the numerical data; they occupy positions in the store temporarily, but are eliminated as the true programme is fed in. Finally, those of the third type constitute the main programme itself. They are of course fed to the store but not used at all until feed-in is complete, at which point the computation can be arranged to start automatically.

There are two controlling instructions which are continually necessary for feed-in; one is the 40-zero instruction as described above, the other the Hollerith Read, required each time a new card is to be fed into the machine. They, or their equivalents, have to be provided manually to start a feeding-in process, and thereafter must be available within the machine; that is, the first card must provide for their being inserted in the store.

General principles and particular details have been established; the chronological sequence of events during the "Start" operation may now be considered:—

1. The Clear switch is depressed, and the Step button operated. The Step button causes whatever instruction is fortuitously set up on the current instruction staticiser to be obeyed (whatever conditions applied when the machine was first switched on, it is almost bound to have stopped with a "Wait" instruction of some sort staticised). An "Obey" beat ensues (which may give almost any transfer) and a "Set-up" beat, at the end of which the staticiser will hold the "40-zero" instruction, since the Clear switch has allowed only zeros to flow to INST. The "40-zero" is a "Wait" instruction, so nothing else happens.

2. The Clear switch is restored, and the Start button operated. The Start button causes the Hollerith Reader to start a card feed. As soon as the first row of holes reaches

the brushes, the "40-zero" instruction is obeyed as a result of the usual cam-operated "Hollerith Go" signal to control. As a result, the word which the first row of holes represents is fed via the "DEST INST" switch to Control, becomes set up on the current instruction staticiser, and is thus the next instruction to be obeyed. The further operations of the machine are (or can be) entirely automatic.

3. The first word on the first card, which is now set up in Control, is an instruction to feed "zeros" to TS0, is a "Go" instruction, and specifies TS0 itself as next instruction source. Therefore, by the time the second row of holes reaches the brushes, the "40-zero" instruction is already circulating in line TS0 (and thus is available in the machine) and is also set up once again in Control. There is a timing point to watch here; the "40-zero" cannot be fed out from TS0 until it is fairly in, so either the first instruction must be of "Forced Discriminate" type, or the transfer must be ordered for at least two minor cycles.

4. The second word on the card is now fed to Control via INST in exactly the same way. It will again be a "Go" instruction, one of those used for preparing the machine. It will probably specify a multiplication of two zero numbers, and destination "Staticiser Reset" (No. 98). It will, as before, specify TS0 as next instruction source. Thus the "40-zero" will be waiting for the third word on the card.

5. This same routine applies to all the initial words on the card—they will be fed to Control, will clear various parts of the machine and will then be lost, leaving the "40-zero" established in Control.

6. The last of the type 1 instructions (those which go straight to Control) will order a transfer of the following line of the card to some specific point in the store—that is, the following line will be a type 2 instruction, to be used for feeding-in the main programme (not necessarily directly) and therefore to be stored temporarily.

7. An obvious way to feed the type 2 instructions into the store is to alternate them on the cards with type 1 instructions, each calling for next instruction source TS0. Indeed, the whole programme could be fed-in in this way, without using type 2 instructions at all, alternate rows going to Control and to storage destinations. It would be very wasteful of punching time and feeding-in time however. In practice, the first type 2 instruction is made to control the feeding-in of a whole batch of type 2 instructions, each of which can then feed in another batch and so on. By this means, every row on the cards is made effective instead of every other row.*

8. One type 2 instruction on the first card must be the "Hollerith Read" instruction, and after it has reached the store it must be called for each time a new card is required. This is not difficult to arrange.

9. When all the type 2 instructions are stored, the feed-in of the main programme commences. Since the machine now has all the stored data necessary, the procedure follows that outlined in Part 2.

10. Summarising, we may say that instructions type 1 are always fed in by a "40-zero" instruction, that instructions type 2 are fed in either by an instruction type 1 or another instruction type 2, and that the main programme is in general fed in by instructions type 2.

(To be Continued)

* The first type 2 instruction is fed to long line x for 16 minor cycles, and therefore fills it completely. The type 1 instruction which ordered it also specified line x as next instruction source, and so does the type 2 instruction itself. Therefore, the next instruction to be obeyed is the type 2 instruction. It orders the transfer of the next line of the card to destination x and of course gives line x as the next instruction source. By choice of the characteristic and timing of the type 2 instruction, it will follow that each of the next 16 rows of the input will flow to line x, each word replacing one of the 16 repeats of the first type 2 instruction as it does so.

Carrier Frequency Generating Equipment for Large Coaxial and Carrier Stations

E. T. C. HARRIS, B.Sc.(Eng.), A.M.I.E.E.,
and S. MUNDAY†

Part 2.—The 124 kc/s Master Oscillator, the Frequency Dividers and the Frequency-Comparison and Alarm Apparatus.

U.D.C. 621.373.42:621.395.44

The first part of this article explained the general features of a new carrier frequency generating equipment for use at large coaxial and carrier stations, outlined the arrangement of the various racks of equipment employed and described the automatic changeover facilities. Part 2 completes the article by describing, in some detail, the 124 kc/s master oscillator, the frequency dividers and the frequency-comparison and alarm apparatus.

124 KC/S MASTER OSCILLATOR

A SIMPLIFIED circuit diagram of a 124 kc/s master oscillator is shown in Fig. 9, from which it is seen that a master oscillator comprises two panels, the master-oscillator amplifier and the oven-control panel. The oscillator is a conventional Meacham¹ bridge crystal-controlled oscillator, valves V1 and V2 being the maintaining amplifier and V3 an output buffer amplifier. The crystal, together with the stabilising lamp, "pulling" inductor and main tuning-capacitor are mounted in the oven unit, the temperature of which is controlled by valves V4 and V5 in the following manner.

TH1 is a thermistor, with a negative resistance/temperature coefficient, mounted in thermal contact with the crystal, and R1 is the oven-heater winding. The V4 stage is arranged as an oscillator with the phase and attenuation of the feed-back path dependent on the resistance of TH1. The connections are such that when the oven is cold, although the thermistor bridge is unbalanced, the phase

change through it does not permit V4 to oscillate. In these circumstances there is no bias on the grid of V5 which, in consequence, passes anode current. This anode current passes through R1 and heats the oven. As the temperature of the oven increases, the resistance of TH1 decreases and the thermistor bridge gradually approaches and eventually passes through the point of balance. V4 will now start to oscillate, the amplitude of the oscillation building up rapidly because the oscillatory current through the bridge will contribute to the heating of TH1 and consequent reduction of its resistance.

The output of V4, about 2 kc/s, is rectified by the metal rectifier, MR, and applied as negative bias to the grid of V5. The magnitude of this bias is sufficient to cut off the anode current and the oven starts to cool. The resistance of TH1 therefore starts to increase and the thermistor bridge re-approaches the balance point, thereby increasing the attenuation of the feed-back path until oscillation ceases.

When the grid circuit of V5 is discharged, anode current flows again and the oven starts to heat again.

This cycle repeats itself, the cooling-time/heating-time ratio being dependent on the ambient temperature, a typical value for the ratio being 2 : 1, with a heating duration of 30 seconds.

The temperature of the oven is maintained to within $\pm 2^\circ\text{C}$ of the operating temperature of the crystal (usually about 50°C).

The variable resistors R2 and R3 provide adjustment for the mean oven temperature and cycling times respectively.

This method of control enables the temperature of the oven to be held more closely to the optimum crystal temperature than is possible with more elementary control methods, e.g., a bi-metallic strip. The circuit also avoids such difficulties as may arise from the pitting of contacts carrying the heating current.

Temperature Alarms.

Thermistor TH2 is used to provide a high- and low-temperature alarm in conjunction with the equipment valve-failure alarm panel.

† The authors are, respectively, Senior Executive Engineer and Assistant Engineer, Transmission and Main Lines Branch, E.-in-C.'s Office.

¹ Meacham, L. A. The Bridge-Stabilised Oscillator. *Proc.I.R.E.*, Vol. 26, No. 10, p. 1278, Oct. 1938.

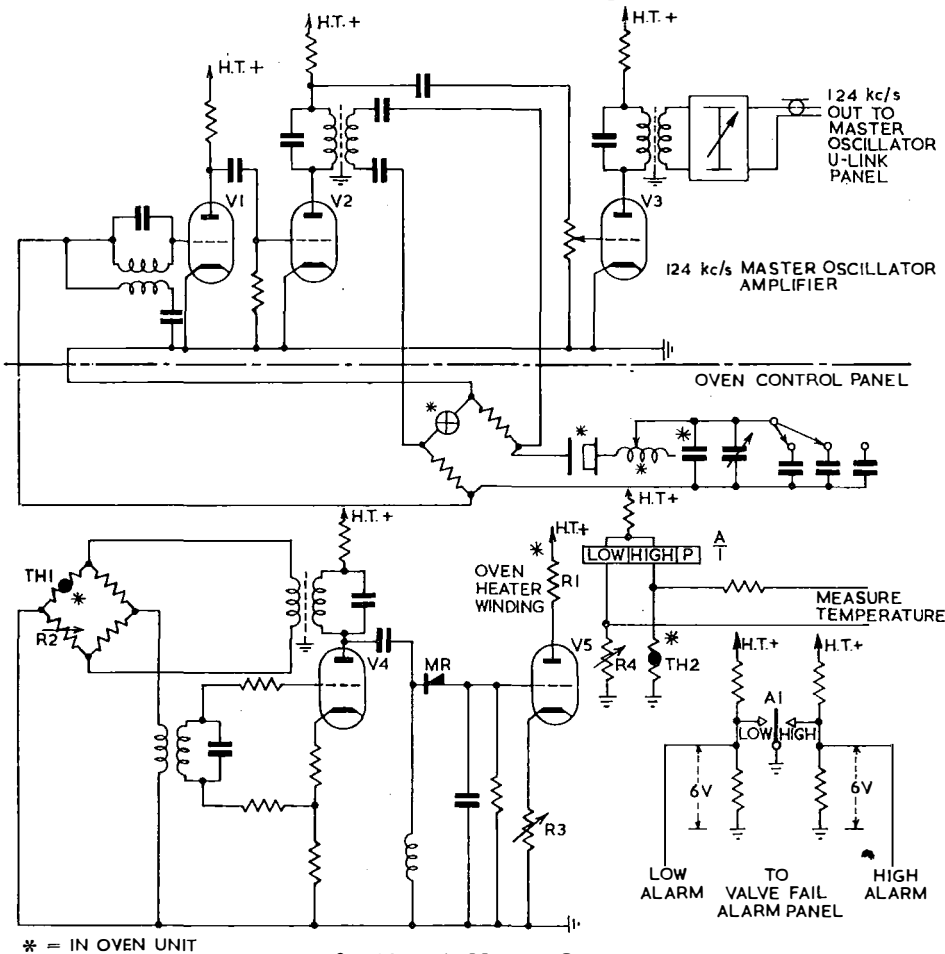

FIG. 9.—124 KC/S MASTER OSCILLATOR.

Resistor R4 in the oven-control panel is adjusted to equal the resistance of TH2 at the mean operating temperature. The currents through the coils of the centre-stable telegraph-type A relay are then equal and the tongue takes up the position shown. Under these conditions two +6V D.C. signals are fed from the H.T. potential dividers to the valve failure alarm panel, which works on the same principle as the level-monitoring panel described in Part 1.

Should the temperature of the oven rise to 5°C above the mean temperature the unbalanced currents in the relay coils will move the tongue so that it earths the "high" contact and short-circuits the +6V signal, thereby operating the alarm panel. Conversely, the "low" contact is earthed for a 5°C fall in temperature. The fault-localising switches on the alarm panel are suitably marked so that the fault can be identified.

Facilities are also provided to measure the voltage across the relay coils so that by reference to a calibration chart or graph, which is provided with the panel, an estimate of the oven temperature may be made.

Performance.

The combined performance of the 124 kc/s master-oscillator amplifier and the oven-control panel is as follows:

Setting accuracy.—The setting accuracy is better than 5 parts in 10^9 of the reference standard. This accuracy is a function both of the frequency-change/degree-of-rotation ratio of the oscillator trimmer capacitor and of the frequency-comparison apparatus.

Drift rate.—After three months' continuous operation the drift rate is better than 2 parts in 10^7 /month.

Frequency/supply-voltage coefficient.—Adverse combinations of 10 per cent. changes in supply voltages do not cause frequency changes greater than 4 parts in 10^8 .

Frequency/ambient-temperature coefficient.—The frequency-drift/ambient-temperature coefficient is better than 1 part in 10^9 /°C over the range 10° to 40°C.

124/60 KC/S AND 60/12/4 KC/S DIVIDERS

The 124/60 kc/s and 60/12/4 kc/s dividers, used to derive the master frequencies from a 124 kc/s master-oscillator output, form one circuit but are mounted on two panels for convenience. The simplified circuit, Fig. 10, shows the frequencies to which the various stages are tuned.

The 124 kc/s input is amplified by V1 and passed to Modulator 1, together with a 4 kc/s signal from a free-running oscillator circuit (V5). The 120 kc/s difference frequency is selected by a simple band-pass filter and passed to Modulator 2, which is in the feed-back circuit of V2. The V2 stage oscillates at 60 kc/s, the process being mutually maintaining so long as the 120 kc/s is present, for the attenuation of the "unswitched" modulator is too great to permit self-oscillation. The output transformer of the V2 stage has its primary tuned to 60 kc/s, and has three secondary windings, providing one output to the 60 kc/s filter-amplifier, one to the 60 kc/s comparison panel and one to Modulator 3 of the next stage.

That this stage is self-maintaining may be seen by assuming that a 48 kc/s input to Modulator 3 exists. The difference frequency, 12 kc/s, is amplified by V3 and one output is rectified by bridge MR1. The alternating currents of the rectified output will contain a strong component of 48 kc/s which is fed back, via the tuned circuit, to maintain the frequency division. Relay A has no function at this stage since it is held operated by the D.C. component of the MR1 output.

The other two 12 kc/s outputs are passed to the 12 kc/s filter-amplifier and the V4 stage. The V4 stage is similar to the V3 stage, and outputs of 4 kc/s are produced by virtue of the tuned circuits and MR2. One 4 kc/s output is fed to the 4 kc/s filter-amplifier and the other back to V5 to lock its oscillator circuit by grid injection.

The 4 kc/s free-running oscillator and relays A and B are incorporated to make the whole circuit self-starting. Provided that an input of 124 kc/s is present, on first switching on a signal of approximately 60 kc/s will be fed to the 60/12/4 kc/s divider. Relay A will act as a vibrator across the H.T. supply, contact A1 being in series

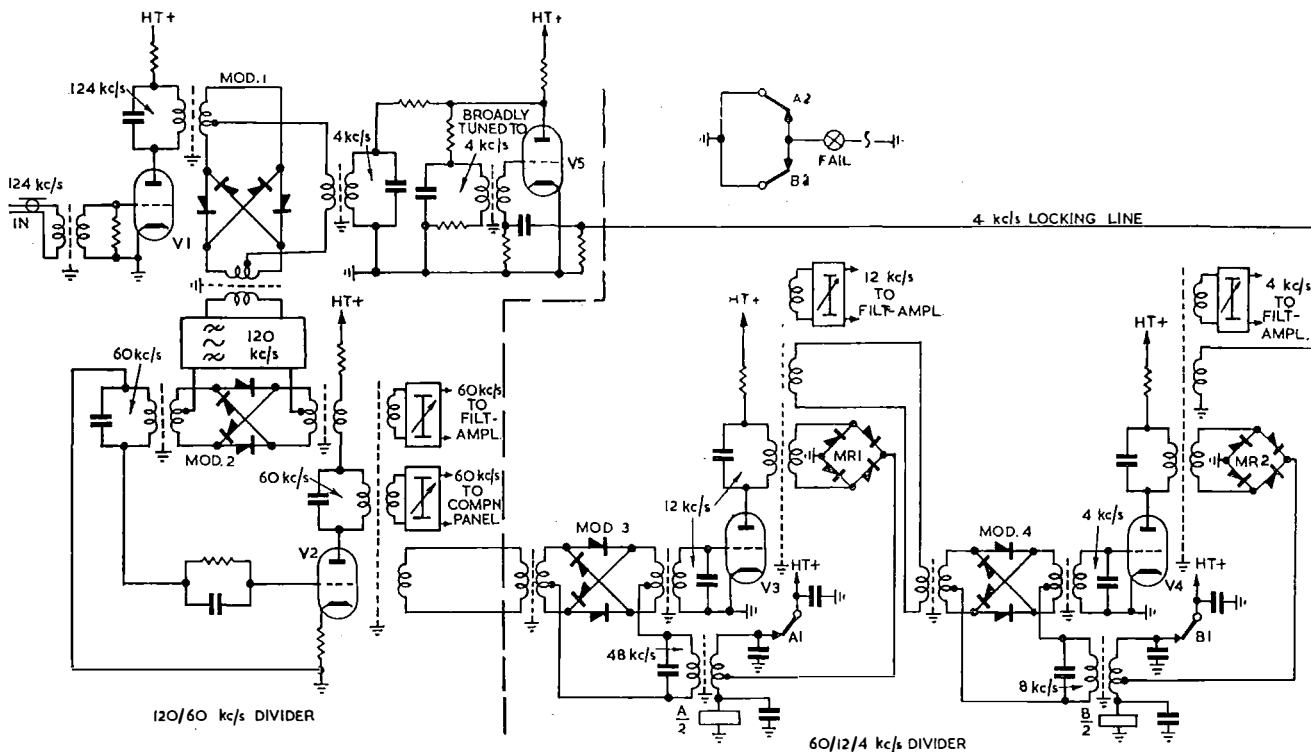

FIG. 10.—FREQUENCY DIVIDERS.

with the coil, and the capacitors associated with this contact will charge and discharge through the primary of the tuned transformer. The 48 kc/s tuned circuit will, therefore, be shock-excited and eventually the V3 stage will be self-maintaining, relay A being held by the D.C. component of the rectified output of MR1.

The V4 stage, in which relay B acts as a vibrator, is similarly self-starting and eventually self-maintaining. The 4 kc/s locking signal synchronises the free-running oscillator and after a short period conditions stabilise themselves and all the derived frequencies are locked to the 124 kc/s output from the master oscillator.

FREQUENCY-COMPARISON AND ALARM APPARATUS

The frequency-comparison apparatus is mounted on the Set 1 master-oscillator generating rack-side (as shown in Fig. 2 of Part 1) and 60 kc/s supplies from the Set 1 and Set 2 dividers, and an incoming 60 kc/s standard signal, are connected to the 60 kc/s comparison panel. Simplified circuits of this panel and the frequency deviation alarm panel are shown in Fig. 11. The comparison panel is used for accurate measurement, and the deviation alarm panel for approximate estimation, of frequency differences.

Comparison Panel.

The comparison and measurement of frequencies are made at 1.8 Mc/s, the frequency differences encountered at 60 kc/s being such that beat indications are inconveniently slow for the desired accuracy of measurement.

The input selection switch enables any two of the three input signals to be selected for comparison and passed to two identical multipliers, each comprising a 60 kc/s buffer amplifier, an overloaded stage and two stages of tuned amplification. The output stage, a pentode with current feedback, is a practically constant-current source. This feature is necessary for the correct operation of the frequency deviation alarm panel, which is described later.

The two 1.8 Mc/s signals are modulated in the rectifier network and the difference frequency produced is normally passed, under control of key K, to the deviation alarm panel, but when K is operated, the difference frequency is displayed as a beat indication on the beat meter. If n beats are observed in t seconds, the frequency difference between the selected 60 kc/s inputs is $n/1.8t$ parts in 10^6 .

To determine the sense of the difference the "sense" key and networks N1 and N2 are provided. The output of Multiplier 2 is passed directly to the modulator, whereas the output of Multiplier 1 goes via the sense key. When the sense key is operated the networks are inserted in the output of Multiplier 1 and the phase change introduced has the effect of momentarily slowing down this 1.8 Mc/s supply to the modulator. If Multiplier 1 output is of higher frequency than Multiplier 2 output, then operation of the sense key causes the beat indication to momentarily slow down whereas if Multiplier 2 output is the higher a momentary speed-up would be observed.

Frequency Deviation Alarm Panel.

The design of the output stages of the multipliers is such that the peak value of the difference-frequency current flowing through the primary of transformer T1 is constant for a given setting of the range switch. The peak secondary voltage is proportional to $2\pi fLI$, where f is the difference frequency, L the primary inductance and I the peak primary current, and, since L and I are constant, the steady-state secondary voltage is directly proportional to frequency.

The voltage applied to the grid of V1 is substantially equal to the peak value of secondary voltage and is positive with respect to cathode. The meter deflection is therefore proportional to frequency, if V1 has a straight-line grid-voltage/anode-current characteristic.

With the range switch in the position shown in Fig. 11 the full-scale deflection corresponds to a difference frequency of 18 c/s between the outputs of Multiplier 1 and Multiplier 2, which is equivalent to 1 part in 10^5 . In the other two positions the full-scale deflections are 1 part in 10^6 and 1 part in 10^7 .

An alarm circuit is provided which can be set to operate at any difference frequency in the range 3 to 10 parts in 10^6 .

CONCLUSION

It can be seen that the "621-Series" equipment has been designed especially for main stations in which large numbers of carrier and coaxial circuits will be terminated. The emphasis throughout has been, where possible, on providing equipment of tried designs, and, since failure of one component may result in the failure of several thousand circuits, a comprehensive monitoring and standby scheme is provided. The continuous monitoring of standby equipment, and the division of the whole equipment into blocks that may be changed over independently, further guards against the likelihood of system failure.

In smaller systems there may not be the same need for guarding against failure, and there will not be the need for a large number of outlets; the 621-Series equipment may be simplified relatively easily until a balance is struck between the facilities required and the provision of equipment. The 621-Series generating equipment for the largest stations, with the simplified schemes for smaller stations, will, it is thought, provide the standard carrier generating equipment in all carrier and coaxial stations for many years.

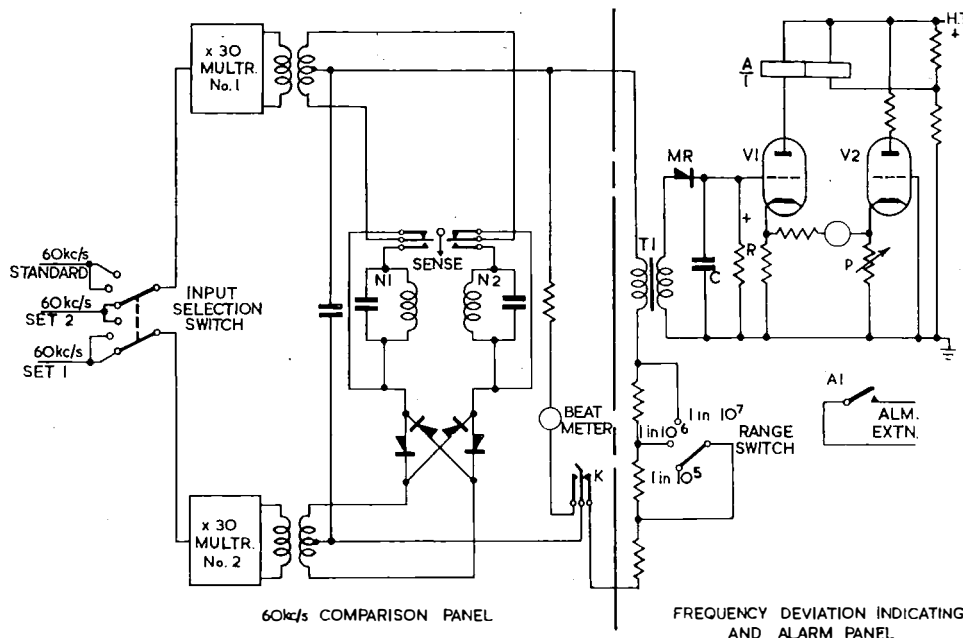

FIG. 11.—FREQUENCY-COMPARISON AND ALARM APPARATUS.

The Laboratory Production of Large Water-Soluble Crystals

E. A. TAYLOR†

U.D.C. 548.5:537.228.1

Under present supply conditions natural quartz crystal is the material most commonly used for the production of the piezo-electric resonators used in filters, oscillators, etc. There are, however, a number of materials from which synthetic crystals having useful piezo-electric characteristics can be produced in the laboratory and the author describes successful production methods developed at the Research Station in recent years.

INTRODUCTION

DURING the years immediately following the second world war, interest in practical applications of piezo-electric phenomena led to a study of the properties and methods of production of a wide range of piezo-electric materials. One cause of this activity has been expressed as follows¹: "Looking to the future, the quartz vibrator is now a vital component for radio and line communication systems. When a component becomes essential, an adequate source of raw material must be found. At present, the sources of satisfactory piezo-electric quartz are few in number The possibility, however remote, of the consumption of the reserves of suitable natural quartz crystal raises the question of the artificial growth of quartz crystal and of other suitable piezo-electric material which can be produced on a commercial scale."

The Research Branch of the Post Office has made some contribution to the second part of this question, particularly as regards the practicability of using water-soluble crystals as replacements for quartz in crystal filters.² Crystals studied in detail, and grown in some quantity, were sodium chlorate, sodium bromate, potassium dihydrogen phosphate (KDP), dipotassium tartrate (DKT), ethylene diamine tartrate (EDT) and ammonium dihydrogen phosphate (ADP). The last named, as well as being a possible material for crystal filters, is of interest as an alternative to Rochelle salt; for example, in microphones for hearing-aids. These researches have now been concluded and the information stored against possible future requirements.

The techniques that have been evolved for producing, or "growing", these crystals in the laboratory owe something to art as well as to science and it is thought that the brief general account which follows will be of interest to readers of the Journal.

CHOICE OF METHOD

The four general ways by which large crystals may be grown are,

- (i) by slow cooling of a melt,
- (ii) by controlled evaporation of a solution,
- (iii) by continuous circulation of a solution which deposits some of its solute in a constant-temperature "growing-chamber" and is replenished in a "strengthening-chamber" containing excess solute at a slightly higher temperature, and
- (iv) by controlled cooling of a saturated solution.

Of these methods, the first is especially appropriate to materials for which there is no satisfactory solvent; the second is useful for substances with a greater solubility in cold than in hot solvent, e.g. lithium sulphate in water; and the third has important advantages in commercial production because the amount deposited during a run is not limited by the amount in solution at the start. For small-scale production of water-soluble substances with suitable temperature/solubility curves the fourth method seems on balance the best, and was, in fact, the only one used by the Post Office.

CONDITIONS FOR SUCCESSFUL GROWTH

It is common for chemistry students to grow large crystals of materials (such as copper sulphate pentahydrate) chosen for the readiness with which they show a characteristic crystal shape. A seed crystal is hung from a thread, or supported on a platform, in a saturated solution, which is then allowed to cool or evaporate slowly.

It was soon evident that variants of such simple means would not give large enough flawless crystals for the present purpose. Suspension threads tested included fine platinum wire, nylon monofil and human hair; none seemed suitable. It was found that essential factors for success were,

- (a) to control the composition of the solution fairly exactly. For a particular material certain additives may be harmless or even beneficial; others, when present in very low concentration, can prevent good growth,
- (b) to start with perfect crystal seeds,
- (c) to support the seeds in such a way as neither to encourage the formation of spontaneous new seeds (as thread supports normally do), nor to hamper the growth of certain faces (as resting on a platform may do),
- (d) to control temperature fluctuations at any time to within a small part of 1°C, and to effect a gradual mean temperature fall, perhaps as slowly as 0.1°C per day, and
- (e) to keep the solution stirred at such a rate as to avoid stagnation effects at any growing crystal surface.

PREPARATION OF SOLUTIONS

For some substances, e.g. sodium chlorate and sodium bromate, suitable solutions were made by dissolving commercially pure crystals or powder in distilled water, and filtering. ADP and KDP solutions could be similarly made, but had to be checked to ensure very low iron content, because a small amount will cause the crystals to taper.

The best available commercial DKT was found to need re-crystallisation before it would provide a solution capable of giving good large crystals. A further point about this solution was that as made by merely dissolving the purified solid in water it gave relatively spindly crystals; if adjusted in pH value by the addition of potassium hydroxide it gave squat-shaped ones more suitable to the purpose for which they were required. (Compare Figs. 1 and 2.)

EDT could not be bought, and its solution was made by combination of ethylene diamine with aqueous tartaric acid. The resulting solution had to contain about 65 per cent. of EDT: the reactants were therefore highly concentrated, and it was necessary to mix with care, as a great deal of heat is evolved by the reaction.

The EDT solution, alone of those used in the work described here, is somewhat unstable. Decomposition products gradually accumulate, and the solution could not be used for more than two or three batches. (With the other materials a solution could be used any number of times, being strengthened, filtered if necessary, and adjusted in temperature, at the end of each batch.) Because of the high cost of ethylene diamine and of tartaric acid much

† Senior Experimental Officer, Post Office Research Station.

¹ Vigoureaux, P., and Booth, C. F. Quartz Vibrators and their Applications. Chapter 24. *H.M.S.O.*, 1950.

² Corke, R. L. Crystal Filters. *P.O.E.E.J.*, Vol. 37, p. 113, Jan., 1945; Vol. 38, pp. 7, 39, 76, 1945.

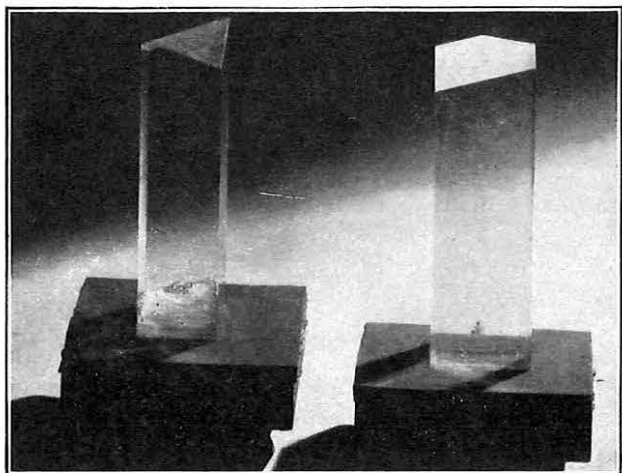

FIG. 1.—DKT CRYSTALS, GROWN IN A SOLUTION TO WHICH NO POTASSIUM HYDROXIDE HAS BEEN ADDED.

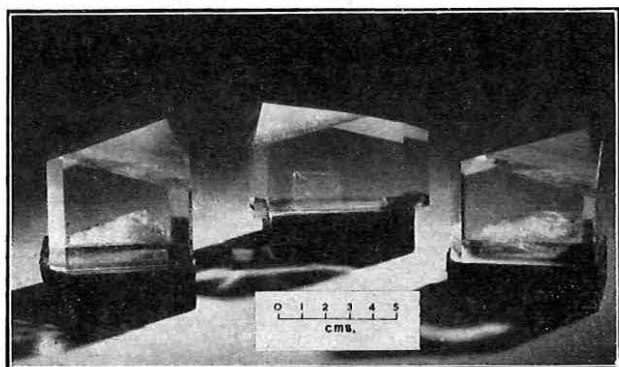

FIG. 2.—DKT CRYSTALS, GROWN IN A SOLUTION TO WHICH POTASSIUM HYDROXIDE HAS BEEN ADDED.

work was done on recovering the EDT from spent solutions, so as to store it in its stable solid form.

PREPARATION AND MOUNTING OF SEEDS

Preparation.

Seeds up to 2-3 mm. across were usually easy to get by allowing a slightly supersaturated solution to stand in a wide, covered vessel. A proportion of the seed crystals not suitable for mounting directly would be nursed up in size by a few days' immersion in very slightly supersaturated solution.

At a later stage, after some large clear crystals had been obtained, the most convenient seeds were plates cut from the best of them. This is especially true of those types of crystal which grow predominantly along one axis, i.e. which show a tendency to grow longer and longer but with little thickening. The necessary increase in the other two axes could be obtained by several successive runs, the seeds for each run being plates, perpendicular to the long axis, cut from the crystals at the end of the previous run.

Mounting.

Fig. 3 illustrates three ways of supporting the seeds of different substances. A1 represents a sodium chlorate seed stuck to the top of a glass pedestal by a film of wax; B1, a KDP seed which is a push fit in a hole cut in a sheet of plastic (the fit is made easier by the habit of KDP crystals to taper from the centre towards both ends); and C1, a sodium bromate seed with a hole drilled to fit a tapered stainless-steel wire. A2, B2 and C2 give an idea of the sort of growth of the clear crystal, around the seeds, hoped for—and sometimes obtained.

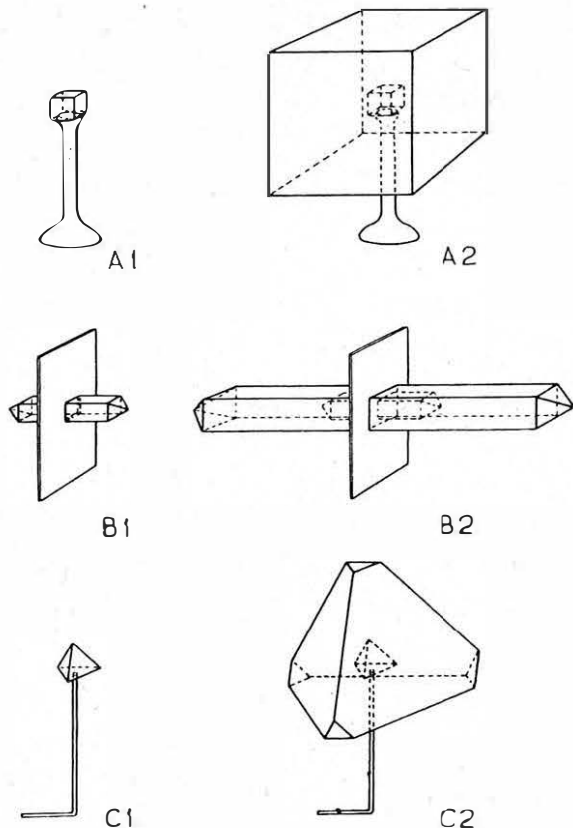

FIG. 3.—MOUNTING OF SEED CRYSTALS.

For growing EDT and DKT from cut plates, holes were drilled in a side face of the plate to take a double support of two stout stainless-steel wires, sheathed in thin plastic tubing where they entered the crystal. Drilling the crystal was a tricky job, and even after much experience some plates were rejected at this stage because of cracks; even worse, some apparently good ones grew into crystals spoiled by mysterious cracks thought (without proof) to be caused by stresses set up during the drilling.

Much effort was spent in trying to stick the seed plates to bakelite platforms, thus avoiding the need to drill. Araldite 101 was the fixative thought to be best, but even with apparently flawless seed plates many of the crystals cracked during growth. As differences in coefficient of expansion might be a cause, trials were next made with the seeds tied to the platforms: nylon and terylene threads, also platinum and molybdenum wires, were all tried as ties, but the cracking was always worse than with stuck-on seed plates. A more successful idea was to interpose between the seed and the bakelite a piece of $\frac{3}{8}$ -in. flexible rubber sheet, using Araldite to fix rubber to bakelite, and seed plate to rubber. With this system, cracks of the sort attributed to mounting stresses were seldom met, and the method was standardised for the relatively large-scale apparatus for EDT and DKT described later.

TEMPERATURE CONTROL

In early experiments it was hoped that ordinary laboratory ovens or incubators, with a temperature constancy of about $\pm\frac{1}{2}^{\circ}\text{C}$, would allow good growth, in sealed vessels, of saturated solutions if manual adjustments to the thermostats (minimum possible adjustment about $\frac{1}{2}$ - 1°C) were made at appropriate intervals. When this hope failed two sets of apparatus were arranged for finer temperature control. These were known as the hot-air rocking box and the hot-water bath, and will be briefly described.

Hot-Air Rocking Box.

This comprised a wooden case 54 in. \times 30 in. \times 28 in. with an inner lining of bakelite sheet, the 3-in. space between the two being filled with granulated cork. Two doors occupying most of a long wall gave good access. To allow inspection of the contents without disturbing the temperature, a double glass window was provided in an end-wall; an internal viewing lamp, permanently on, was part of the heating system. An electric fan mounted on the roof, with its motor outside but blades inside the box, gave very good air circulation. Boosting heat was provided by tubular lamps mounted vertically on the walls and switched by a bi-metallic thermostat acting through a hot-wire relay. In spite of the inherent faults of any thermostat in which air is the medium conveying the heat—faults arising from the low heat capacity of the medium and consequent operating lag—the arrangement gave control to $\pm 0.1^\circ\text{C}$, with good stability.

To provide for mechanical adjustment of mean temperature, the thermostat control knob was coupled through several stages of worm-gearing to an electric motor. Running continuously, the motor would have driven the spindle at about three revolutions per year, corresponding to a temperature drop of 1°C per day; to slow this rate down the motor was controlled through a thermal switch which gave a short-time switching cycle with any desired on/off ratio. Thus any rate of temperature fall up to a maximum of 1°C per day could be smoothly attained.

Hot-Water Bath.

The 100-gallon galvanized-iron tank used as a hot-water bath was equipped with,

- (a) two immersion heaters with a parallel-series switch to give either 4 kW or 1 kW;
- (b) a $\frac{1}{3}$ -h.p. motor stirrer with a 4-in. rotor;
- (c) a toluene bulb thermostat with a proportioning head operating through an electronic relay;
- (d) a constant-level device to replace water lost by evaporation;
- (e) thermometers; and
- (f) suitable stands, with or without rocking devices, for glass vessels.

The uniformity and constancy of temperature in this bath were excellent. Except very near to the heaters, water temperatures from one part to another differed by not more than a few hundredths of 1°C ; and in the central working space no variation was visible on a Beckmann thermometer during intervals of several hours, showing that fluctuations were not more than about 0.001°C .

The thermostat is based on a mercury-toluene bulb. To arrange for a steadily falling temperature the bulb was modified by the addition of a side tube through which an accurately machined piston-and-cylinder was able to force extra mercury into the bulb. Motion of the piston was effected by a clock-motor through appropriate gears, and since the motor voltage was supplied through the thermal switch a smooth temperature decrease at any desired rate between, say, 0.05° and 1°C per day could be provided with precision.

The general layout of the bath is shown diagrammatically in Fig. 4.

For EDT and DKT, which were grown on a scale rather too large to permit immersion in the water bath, it was luckily found that a lower order of thermostat accuracy was sufficient. Bulbs based on the usual mercury-toluene pattern were designed for immersion in the individual vessels of saturated solution; they were of such dimensions that 1°C temperature change would cause about $2\frac{1}{2}$ cm. movement of the mercury meniscus in a $1\frac{1}{2}$ -mm. tube, and

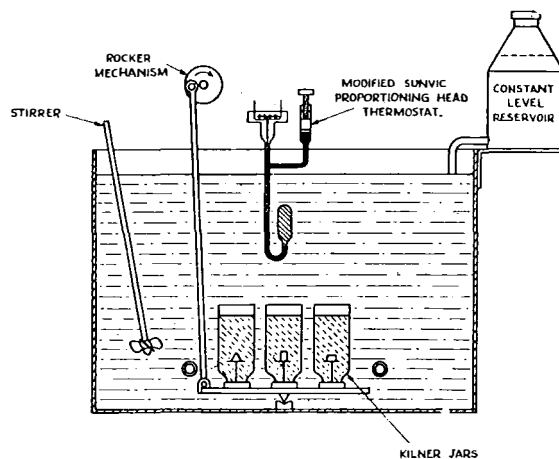

FIG. 4.—HOT-WATER BATH.

were provided with a side-bulb to allow instantaneous readjustments of mercury level in the tube.

The steel needle making contact with the mercury surface was mounted in a threaded rod, the rotation of which, by carrying the needle downwards, caused a steady fall in the mean temperature. Rotation of the rod was effected by a clock-motor whose 1-r.p.m. spindle operated through a worm and 38-tooth gear-wheel. The thread on the rod being 60 to the inch the maximum movement rate of the needle-point was 1 in. (equivalent to 1°C) in 38×60 minutes. By putting a thermal switch in the clock-motor circuit the movement was reduced to the necessary amount, generally between 0.1 and 0.2 in. per day.

At its best, this simple thermostat was of much greater precision than was needed; with a good mercury meniscus it was responsive to changes of less than 0.01°C . Because stirring in the tanks of solution could not be vigorous, there would have been a substantial operating lag—enough to cause swings of $\pm 0.25^\circ\text{C}$ —but this was almost completely eliminated by direct radiant heat on the thermostat bulb. The lamp providing the radiation was in parallel with the booster heater, and by causing premature switching-off it ensured that the heat input was always by short pulses with no over-shooting.

The chief defect of the thermostat was that the mercury meniscus became dirty. Partly through the small but frequent “breaking” spark at the surface—suppression of which by simple devices led to worse troubles and was abandoned—and partly through atmospheric dust, a degree of “tailing” was usually present after a few months. This caused a loss of precision, but not to a serious extent; it was exceptional for short-term swings to exceed $\pm 0.05^\circ\text{C}$.

STIRRING THE SOLUTION

The hot-air box was suspended in a massive wooden cradle and could be rocked longitudinally, through an angle of 7° each side of its mean (horizontal) position, at about 30 cycles per minute. Glass vessels in the box could therefore be kept in continuous movement in a way which is the most effective for growing ADP and KDP. In these, deposition occurs predominantly on the pyramidal end-faces and is favoured by placing the seeds lengthwise to the direction of rocking so that the solution laps over the growing faces. A similar rocking action was arranged in the hot-water bath.

Other types of crystal grow better with more emphatic stirring, and the general procedure adopted was to mount the seeds on arms extending horizontally from a vertical spindle centrally placed in the vessel. A suitable method of rotating the spindle first one way and then the other ensured adequate motion of the crystals relative to the solution.

VESSELS AND ASSOCIATED APPARATUS

The first vessels used were beakers and glass boxes which could be covered in such a way as to prevent evaporation. For immersion in the hot-water bath Kilner jars were found convenient because they are easy to make water-tight. Such vessels were sometimes static, sometimes rocked; one crystal was grown in each, in a volume of 1–2 litres.

The next stage was the modification of glass desiccators, holding $2\frac{1}{2}$ litres. Through the hole in the lid was clamped a rubber-sealed brass tube to act as the bearing for a central spindle which could be rotated by a clock motor: the seed crystal was carried on an arm at the bottom of the spindle. A specially designed toggle clamp held the lid in place to permit immersion in the hot-water bath. After the inadequacy of unvarying rotation had been proved, a simple means of reversing the rotation was incorporated.

Increasing somewhat the scale of working, Pyrex glass cylindrical tanks were next used of various sizes up to 37 litres capacity. It was in these that most of the useful crystals were produced. Each tank was provided with a lid in gear bakelite, clamping down over a rubber gasket. Holes in the lid allowed for the entry of the spindle carrying the arms on which the seeds were mounted, the thermostat controller (mercury-toluene bulb), a thermometer (usually 0–50°C graduated in fifths), a funnel for pouring solution, siphon tubes, etc. The spindle was mounted slightly off-centre to give the optimum use of the space left after the thermostat bulb had been inserted. In the smaller (20-litre) tank there were four crystal-bearing arms in two pairs at 90° to each other. Each large tank had three arms as nearly as possible on one level and at 120° to each other, with a similar trio higher up the spindle displaced 60° relative to the lower ones.

Stirring was done by a $\frac{1}{50}$ -h.p. motor on the lid, with a worm gear to give a spindle speed of 20 r.p.m. Cam-operated sets of contacts repeatedly changed the mains connections to the motor terminals, and hence the direction of rotation, with a complete cycle time of one minute.

Unfortunately, no small motor was found which would run smoothly under these conditions for 24 hours per day, for many months. Vibration always developed. It was therefore arranged to rotate the spindle by a flexible drive. The power unit was a three-phase $\frac{1}{2}$ -h.p. motor, operating

a shaft from which branched separate flexible drives for six tanks, each drive coming through a 15 : 1 reduction gearbox. Cam-driven contacts allowed for rotation reversals, with the necessary dead time between, each half-minute. A tank unit is shown in Fig. 5.

CRYSTAL GROWING RUN

General Procedure.

In this and the remaining sections, any details given relate particularly to growing EDT. For other substances there would be minor variations, e.g. in the range of temperatures.

A suitable amount of supersaturated solution was kept at $55^{\circ}\text{C} \pm \frac{1}{4}^{\circ}\text{C}$ for as long as convenient—preferably at least a week—with occasional shaking. If deposition did not begin spontaneously during the first day it was induced by the addition of a pinch of pure powdered EDT. The day before the run was to begin the solution, by that time almost precisely saturated at 55°C, was carefully decanted from the deposited solid into clean pre-heated flasks, which were then put into an oven at 57°C.

Also on the day before the start, the seed crystals were secured to the spindle, the tank unit assembled, its lid screwed down, and heat applied to raise the temperature slowly, reaching 57°C by the next morning. The solution was then poured through the hole provided, which was corked immediately afterwards. Being slightly unsaturated at 57°C the solution began to dissolve the seeds, thus removing any loose fragments which might otherwise have acted as nuclei for wrongly oriented growth. The temperature was reduced in the course of three or four hours to a point at which growth was just beginning, probably a little above 55°C. Close scrutiny, with special lighting, enabled this point to be determined fairly accurately after some experience; it was shown either by a fluffiness of the growing faces, or by a characteristic brightness where faces met.

During the growth period the bath was examined each day, and its temperature recorded. Cooling was arranged at a rate based primarily on the ratio of growing crystal surfaces to volume of solution. The rate, usually between 0.1 and 0.2°C per day, was modified as needed after observation of the amount and quality of growth.

When the temperature had fallen to 41°C or when the growing crystals had used up the available space, the solution was siphoned from the tank and the system allowed to cool slowly for 24 hours. When at atmospheric temperature, the crystals were removed, dried and wrapped for storage until required.

Temperature Range.

Work on EDT was begun with the temperature range generally used for other materials, i.e. about 36–22°C. After a promising start it was found that the crystals had suddenly begun to grow much faster, and to change their shapes. Tests showed that the new form, which once introduced was the product invariably obtained under the conditions so far used, was a hydrated EDT, unstable to moderate heat or to low relative humidity. This same unexpected transformation apparently occurred in each laboratory where work was done independently on EDT. At about the time that this was observed by the author, the explanation was published in U.S.A., where intensive study of EDT had already been going on for some years. The substance has a critical temperature of 41°C; above this the desired anhydrous form, below it a hydrated form, is stable in contact with the saturated solution. This knowledge naturally led to a choice of temperature range entirely above 41° for growing; once away from contact with the solution, the anhydrous material is the more stable variety.

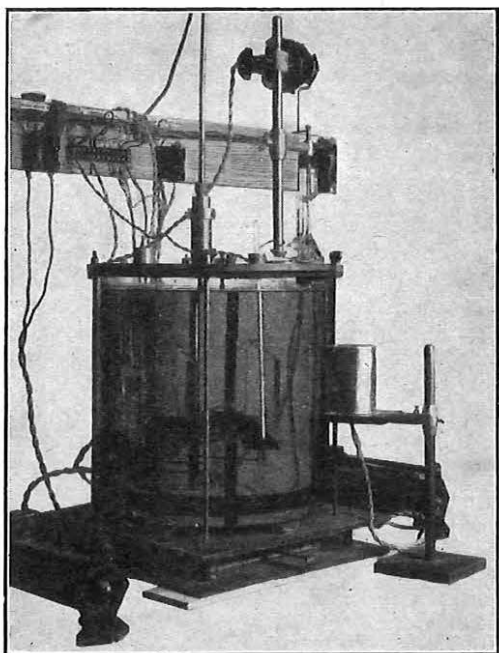

FIG. 5.—CYLINDRICAL GLASS TANK USED FOR GROWING CRYSTALS.

NORMAL AND ABNORMAL GROWTH

An ideal EDT crystal is shown in Fig. 6. If it is arranged that all the surface of such a crystal is equally exposed to a slightly supersaturated solution of EDT, deposition proceeds almost entirely on the faces marked $(1\bar{1}0)$ and

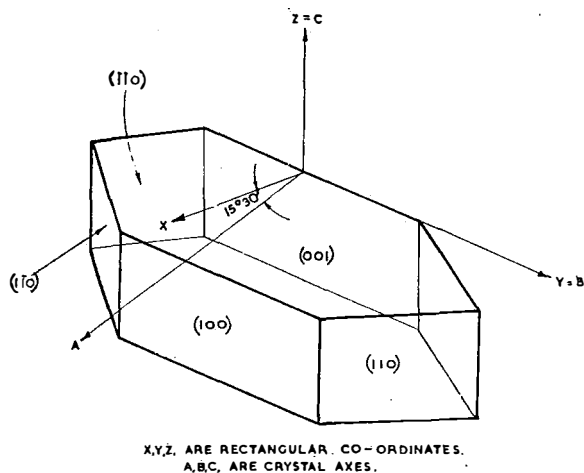

FIG. 6.—IDEAL FORM OF EDT CRYSTAL.

$(\bar{1}\bar{1}0)$. Thus there is a much greater proportionate increase in length than in breadth or thickness, and a much faster length growth in one sense than in the other. This is an instance of the individualistic behaviour of crystals; most substances grow more symmetrically, but each must be studied separately to find its habits.

With working degrees of supersaturation, typical length increase is about 1 mm. per day. The fastest flawless growth recorded was 2–2½ mm. per day.

A cut piece of crystal used as seed must first develop its natural faces before normal growth begins. Referring to Fig. 7, if a plate cut as in A (a so-called Y-cut plate, i.e.

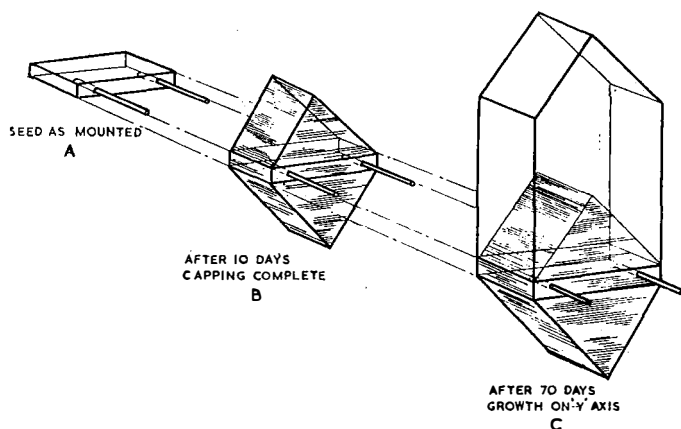

FIG. 7.—GROWTH OF EDT CRYSTAL.

one perpendicular to the Y axis) is suspended in a suitable solution it will acquire peaks on both sides as in B. Invariably most of the deposited material during this "capping" stage is cloudy; thereafter clear growth is possible and may lead to the shape shown in C. For a given degree of supersaturation the growth rate during capping is much faster than during normal growth.

In the ideal EDT crystal the long edges are parallel, but in fact most large crystals show some tapering towards the apex. It is well known that crystal tapering in general can be caused by specific impurities and that in EDT one of the verified causes is an unduly low pH value. With solution made as described earlier, and adjusted to pH 7.0–7.5, tapering was usually negligible, but well-shaped crystals were also grown from direct solutions of solid EDT, the pH of which was 6.3–6.5.

Occasionally, for no known reason, a crystal grew several times as fast as normal. The high speed was always associated with cloudy growth and bad shape. It was liable to happen while good growth was at the same time occurring on other crystals in the same bath. Such abnormal growth was particularly noticed on crystals in which the Z dimension exceeded the X, and seed pieces with that shape were therefore later avoided.

Another common growth-irregularity was the occurrence of thin sheets of cloudy material parallel to the growing $[(1\bar{1}0)$ and $(\bar{1}\bar{1}0)]$ faces, to describe which the word "veils" was used. Veils follow any sufficiently sharp or prolonged discontinuity of growing conditions, especially of temperature or stirring. They may also be caused by mechanical shock to the growing faces. This happened occasionally through impact by minute fragments of drifting crystal which had either become detached from a main crystal or had arisen by spontaneous nucleation. (The extreme sensitivity of the growing faces was proved by the inducing of such veils through gentle stroking with a rubber-covered glass rod.) The cause of a veil having been once removed, clear growth could usually be re-established, and the veils were not found to spread either before or after removal of the crystals from the solution.

Cracks were a source of much trouble, but became steadily less frequent as a result of "selective breeding" and of practice in technique. In DKT and some other materials there are pronounced cleavage planes and a crack tends to split the crystal parallel to one face: EDT cracks, in contrast, have usually a sharp curvature. As the crystal grows the crack usually extends into the new growth, but, because of the curvature, it terminates on an external face, after which further growth may be flawless. It was found possible to make an artificial termination of a troublesome crack by deliberate production of a veil, but only at the risk of upsetting the growth in other ways.

CONCLUSIONS

The above brief account may suggest that this growing of crystals was a dull business of waiting upon an imperceptibly slow natural process. Certainly patience was needed; an attempt to speed up the process was likely to ruin it. There were, however, highlights; for example, it was discovered one morning that the floor of a glass tank had cracked, and during the night had allowed about 20 litres of hot saturated EDT solution to run over the bench and the floor. Having cooled, it was when found a remarkably messy mixture of syrupy liquid and small crystals.

In a lesser way every batch had its own crises—the first observable growth, the end of capping, the "harvesting"—as well as the possibility of aberrations. As the best of these large crystals, seen in a sparkling solution or immediately after withdrawal, had the beauty of oversize polished diamonds, it was almost with regret that they were handed over to be cut up.

The Dover-Deal Experimental Cable

H. C. S. HAYES, M.I.E.E.†

Part 1.—Description of Cable, Factory Tests, Installation and Jointing

U.D.C. 621.315.221.8:678.742.2:621.315.53

A cable with polythene sheath and paper-insulated, aluminium conductors has been installed as an experiment between Dover and Deal. Provision is made for passing dry gas or air through the cable if its insulation resistance falls due to molecular penetration of water vapour through the sheath. Also, a pressure of air is maintained in the cable so that faults in the cable sheath can be detected. Part 1 of this article describes the cable, gives the results of tests on factory lengths, including pneumatic resistance, and describes the installation and jointing of the cable. Part 2 will conclude the article by describing the measurements of gas flow characteristics during installation, the gas-drying and gas-pressure arrangements and the results of tests on a loading-coil section and on the completed cable.

INTRODUCTION

POLYTHENE, good as it is in preventing the passage of moisture, is by no means a perfect barrier to molecules of water vapour, and it is generally recognised that only a complete metallic sheath, such as lead or aluminium, can effectively bar the infiltration of molecular moisture into the dry paper insulation of a telephone cable. On the other hand it is common knowledge that low insulation resistance in a paper-insulated cable, due to the presence of traces of dampness within the dielectric, can often be brought up to normal by "gassing," i.e. by passing dry air or other suitable gas through the cable. Thus it should be possible, choosing the right conditions, to counter any fall in the insulation resistance of the paper within a polythene-sheathed cable by gassing, either continuously or at intervals, and this basically is the idea underlying the Dover-Deal cable experiment. The cable has paper-wrapped aluminium conductors enclosed in a polythene sheath. It is not intended to "gas" from the outset but to observe the rate at which the insulation falls, the changes which result in the transmission characteristics of the cable pairs, and the effects on working circuits. If it becomes clear that the proper working of the circuits is likely to be affected, the gassing arrangements, all held in readiness, will be brought into use.

The cable is also being kept permanently under gas (dry air) pressure to enable defects in the sheath or sheath joints to be detected and cleared. In this way it is hoped to differentiate between localised low insulation due to sheath defects and general low insulation resulting from the slow ingress of molecular moisture through the sound cable sheath. The gas under pressure within the cable is not expected to have any material effect on the rate of ingress of molecular moisture through the polythene sheath.

The experimental cable was brought into service in June 1955.

DESCRIPTION OF THE CABLE

Route and Pair Distribution.

A straight line diagram of the cable, which is balanced and loaded with 88-mH coils at 2,000 yd. (nominal) spacing,

is shown in Fig. 1. There are 54 pairs between Dover and Deal with a 28-pair spur into Kingsdown. The conductors are of aluminium of a standard gauge chosen to have approximately the same resistance per mile as 20-lb. copper conductors. For practically the whole of its length the cable was drawn over one, two, or, in some sections, three other cables in the same way of the multiple duct. This is really a fortunate feature because, although the cable diameter is rather greater than that of a conventional copper-paper-lead cable, the larger diameter does not, to any extent, lead to the wasteful use of duct space for, over much of the length, insufficient duct space would have remained to accommodate a further cable even if the smaller conventional cable had been used.

Before the route was finally chosen for the trial, the noise levels on selected pairs in an existing lead-covered cable between Dover and Deal were measured. These were found to be so low that, when due allowance was made for the absence of the screening lead sheath on the experimental cable, there was clearly no risk of noise interference. It may be of interest to add that similar tests made on a number of cable routes known to be parallel to power lines or electric railways, or both, indicated that on about 5 per cent. only of these would omission of the screen have appreciable adverse effect at the present time. This estimate may require review when railway electrification becomes more general.

Features of Cable Make-up and Design.

The principal features of the make-up of the cable are shown in Fig. 2. For purposes of comparison some details are given in the figure for the equivalent copper-paper-lead cable with 20-lb. conductors (0.036 in. diameter).

The experimental cable core is of normal star-quad construction with 0.044 in. diameter semi-annealed aluminium conductors, which leads to the use of the designations 54/0.044 and 28/0.044 for the main and spur cables. Around the core are two layers of paper and two open helical lappings of 2-mil aluminium tape applied to break joint. This tape was included because it was felt it might be desirable to stabilise the capacitances to earth of the wires and it also facilitated the testing of the polythene sheath in the factory. As it is so thin, the tape provides negligible screening of the circuits against variations in extraneous magnetic fields but, as already stated, interference from such fields is not a problem on this route.

It had been found from early measurements made on lead-sheathed cable that the pneumatic resistance of a cable, as would be expected, varies greatly with the compactness of the core and the space existing between the core and the sheath. In this case it was desired to have as low a pneumatic resistance as was compatible with a good make-up, and a degree of looseness was aimed at in the design to give

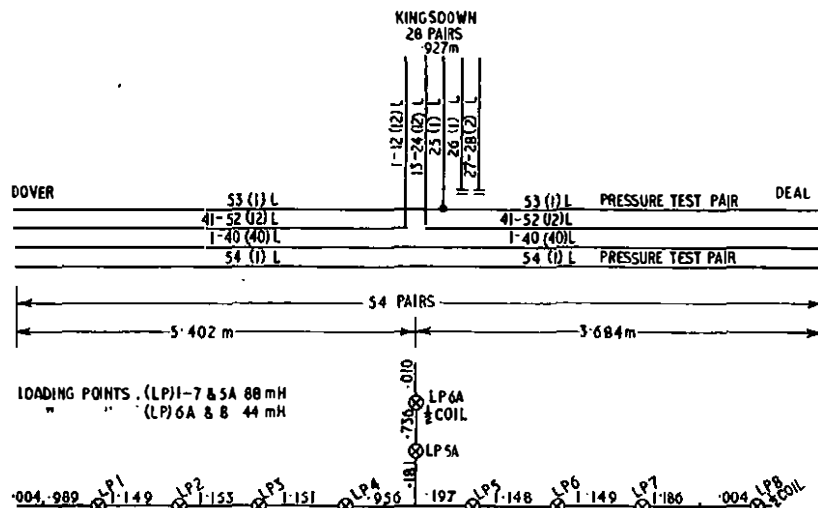
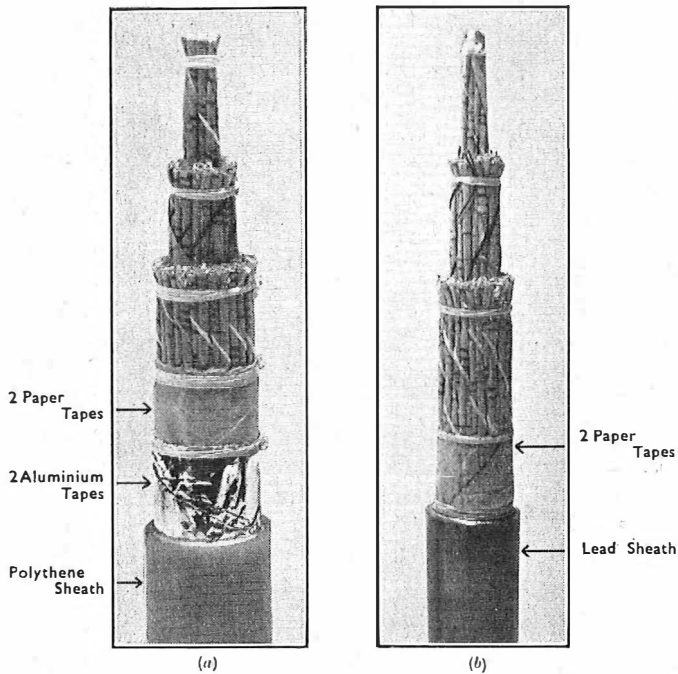

FIG. 1.—DIAGRAM OF THE DOVER-DEAL EXPERIMENTAL CABLE.

†Assistant Staff Engineer, External Plant and Protection Branch, E.-in-C.'s Office.



(a) Experimental 54-pair Polythene-Sheathed Cable, with 0.044-in. diameter Aluminium Conductors. (Overall diameter: 1.27 in.)
 (b) Conventional 54-pair Lead-Sheathed Cable, with 0.036-in. diameter Copper Conductors. (Overall diameter: 0.94 in.)

FIG. 2.—CABLE MAKE-UP.

a mutual capacitance somewhat lower than normal. The mean mutual capacitance attained was about 0.063 microfarads per mile.

To enable the pneumatic resistance to be kept under review during manufacture, the specification called for its measurement on every length, and the values obtained are included in the summary of the factory-length test figures which are referred to later.

For the purposes of the experiment, the resistance to gas flow of a length of cable in which a pressure of 10 lb/sq. in. at one end produces a steady flow of gas of 10 cu. ft./hr. at the other when open to the atmosphere, was taken as the Unit of Pneumatic Resistance (u.p.r.). Strictly, all values of pneumatic resistance should have been at, or corrected to, a standard temperature and pressure, but this was not considered necessary as any such correction would have been small compared with experimental error.

The polythene sheath, which is a light pink in colour, is approximately 100 mils in thickness for the 54-pair cable and 80 mils for the 28-pair cable. Grade 2 polythene containing about 10 per cent. P.I.B. (polyisobutylene) and a small quantity of anti-oxidant, 0.1 per cent., was used for the extrusion. Carbon black was omitted as it was felt that its inclusion might, to some extent, increase the permeability of the sheath to water vapour. Once the cable was *in situ* no deterioration due to the action of light in the absence of the carbon black was anticipated but, to avoid any such possibility during transport, the outer convolutions of the cable on the drums were covered with stout paper and the drums were kept closely battened to prevent the cable from being exposed to sunlight.

Weight and Cost of Materials.

As indicated by the relative densities shown in brackets, the principal component materials of the experimental cable, polythene (0.9) and aluminium (2.7) are much lighter than their lead (11.4) and copper (8.9) counterparts. The net result of this is that the experimental cable is only about one-third the weight of the corresponding

54/20 P.C.Q.T. copper-paper-lead cable. The actual weights of the components in a sample foot length of each are given in Table 1.

TABLE 1
Weights of Components in a One-Foot Length of Cable

54/044 Experimental Cable			Standard 54/20 P.C.Q.T. Copper-Paper-Lead Cable		
	Grams	Per-centage of Total Weight		Grams	Per-centage of Total Weight
Polythene Sheath	96.6	41.3	Lead Sheath	402.0	67.8
Aluminium Screen	6.8	2.9	Copper Wire	190.2	27.9
Aluminium Wire	89.1	38.1	Paper and Cotton	29.0	4.3
Paper and Cotton	41.5	17.7			
Total	234.0	100.0	Total	681.2	100.0

Relative weights, $\frac{234.0}{681.2} = 34.4$ per cent.

At the prices of materials which were current in the early part of 1955, and which are given approximately in Table 2, the total cost of the components of a factory length of the experimental cable is about two-thirds of that of its copper-paper-lead equivalent. The costs of the polythene and lead for the sheaths are roughly the same, but the saving results from the use of aluminium instead of copper for the conductors (see Table 3). It must be emphasised that the production costs of the two types of cable are likely to be different and these would require comparing under similar stable conditions of manufacture before any true overall cost comparison of the two types of cable could be made.

TABLE 2
Prices of Materials used in the Experimental Cable

Material	Price	Material	Price
Copper Wire	£400 per ton	Cotton, 3/40, Coloured ..	9s. 0d. per lb.
Lead	£100 per ton	Cotton, 4/10, White	4s. 7½d. per lb.
Paper, 0.0035 in. thick	1s. 9d. per lb.	Aluminium Wire, 0.044 in. dia.	£300 per ton
Paper, 0.005 in. thick	1s. 7½d. per lb.	Aluminium Tape, 0.002 in. thick	3s. 2d. per lb.
		Polythene +10 per cent. P.I.B.	4s. 3d. per lb.

TABLE 3
Relative Cost of Cable Components (Materials Only)

54/044 Experimental Cable		Standard 54/20 P.C.Q.T. Copper-Paper-Lead Cable	
Polythene	60	Lead	61
Aluminium Screen ..	3	Copper Wire	100*
Aluminium Wire	35	Paper and Cotton ..	10
Paper and Cotton	14		
	112		171

* Arbitrarily assigned as 100 for purposes of comparison.

$$\text{Ratio of values} = \frac{112}{171} = 66 \text{ per cent.}$$

Factory-Lengths Tests.

Perhaps the values of greatest interest in the summary of works tests, Table 4, are those for the resistance presented by the cable to the flow of gas; i.e., the pneumatic resistance figures. However, as insulation, resistance, capacitance and capacitance-unbalance measurements are normally made on factory lengths of trunk and junction cables the figures for these are included for completeness.

The gas flow measurements were made on 27 nominal 500-yd. lengths of the 54/044 cable and on three other lengths of the 28/044 cable, and the electrical measurements on 33 lengths, nominally 500 yd. long, of 54/044 cable and on four other lengths of 28/044 cable. The capacitance-unbalance figures are corrected as if they had been for 176-yd. lengths.

TABLE 4
Summary of Factory Tests (July 1954)

PNEUMATIC RESISTANCE (Units of Pneumatic Resistance, u.p.r.)
54/044 cable. Average 4.2 for 500 yd.
28/044 cable. Average 6.3 for 500 yd.

INSULATION AND CONDUCTOR RESISTANCE

Cable Size	Insulation Resistance (megohms/mile after electrification for one minute)	Conductor Resistance (ohms/wire-mile)		% Unbalance. (Resistance) between Wires of a Pair	
		Max.	Min.	Max.	Min.
54/044	22,000	47.8	44.9	1.79	
28/044	27,000	45.9	45.2	0.70	

MUTUAL CAPACITANCE (micro-farads per mile)

54/044 .. Max. 0.0648 Mean 0.0625 Min. 0.0608
28/044 .. Max. 0.0625 Mean 0.0612 Min. 0.0606

CAPACITANCE UNBALANCE (micro-micro-farads)

Cable Size	Side/Side		Pair/Pair		Side/Earth	
	Max.	Mean	Max.	Mean	Max.	Mean
54/044	84	21	41	10	252	53
28/044	28	19	27	6	127	49

For the pneumatic measurements an air pressure of 10 lb/sq. in. was maintained at the input end of the cable length above that at the output end and the resulting gas flow in cu.ft./hr. was measured with a gas flow-meter at the output end. For the 54-pair cable the maximum rate of flow was 2.8 cu.ft./hr. through a length of 516 yd., and the minimum 1.8 cu.ft./hr. through a 502-yd. length. The average rate of flow for 500 yd. (correction for length on a linear basis) was 2.4 cu.ft./hr. The flows measured on the three lengths of the 28-pair cable, 480, 460 and 278 yd., were respectively 1.7, 1.7 and 3.0 cu.ft./hr.; say 1.6 for 500 yd. In u.p.r. the 500-yd. lengths of the 54-pair and 28-pair cables thus had average values of pneumatic resistance of $10/2.4 = 4.2$ and $10/1.6 = 6.3$ respectively.

In the factory it was found convenient to measure the rate of gas flow on a direct-reading flow-meter. This instrument consists essentially of a light float index contained in a tapering metal tube whose internal diameter is greatest at the top end. The gas passes up the tube and its flow raises the float. The higher the float goes, the less the lift because, owing to the taper, a greater proportion of the gas passes between the float and the tube side without exerting any lift. Thus the float attains a position of equilibrium and the height of the index above a datum is calibrated to give a direct measure of the rate of gas flow.

INSTALLATION AND JOINTING

After manufacture the cable was accommodated on drums of barrel diameter 36 in. and flange diameter 60 in. A nominal 500 yd. was wound on each drum and the total weight of a full drum was approximately 13 cwt. (drum 6 cwt., cable 7 cwt.). The weight of the same drum loaded with 500 yd. of 54/20 copper-paper-lead cable would have been almost exactly twice as much.

Pulling-in.

The light weight of the cable, the comparatively low coefficient of friction between the polythene and the duct



FIG. 3.—DRAWING-IN THE CABLE.

or the other cables already in it, the cleanliness of the sheath itself, and the absence of the usual petroleum-jelly lubricant, all combined to make the working conditions for the installation staff exceptionally good. Fig. 3 shows the drawing-in of a 350-yd. length off a full drum. The facility of being able to cable direct from the vehicle was found to be a valuable one and the ease with which one man could support and guide quite a long length of cable between the vehicle and the jointing chamber allowed considerable latitude for positioning the vehicle.

The pulling-in rope was attached to the cable end by means of a standard cable grip, a metal spike being first driven into the end of the cable, see Fig. 4, to ensure that the main pull was taken by the conductors rather than by the sheath.

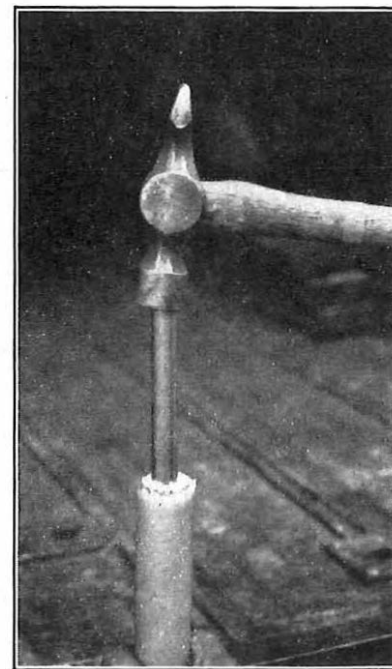

FIG. 4.—SPIKING THE CABLE BEFORE PULLING-IN.

Sealing the Cable Ends.

The ends of the cable as sent out from the factory were sealed with wax, but when a cable length was cut during installation, temporary sealing was effected by melting polythene strip, cut from short scrap lengths of cable, around the end of the cable by means of a blow-lamp flame, as shown in Fig. 5.

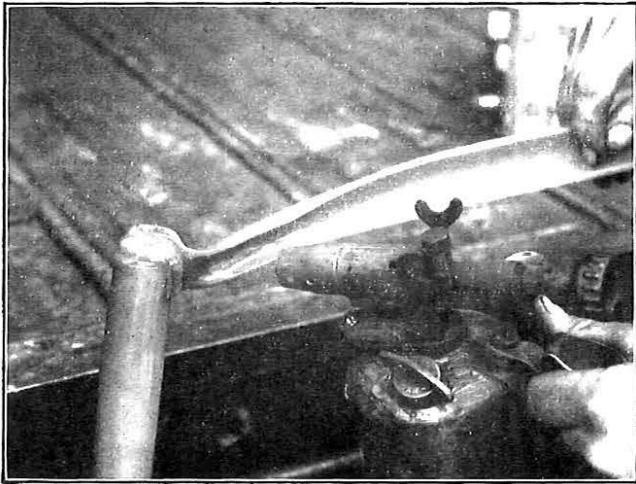

FIG. 5.—TEMPORARILY SEALING THE END OF THE CABLE.

Jointing.

In the main the jointing technique followed the standard method employed for polythene-insulated and polythene-sheathed cables described in a previous issue of this Journal.¹ The main differences and points of interest are outlined below.

Conductor Jointing.—The aluminium conductors, insulated with their paper wrapping, were jointed together exactly as if they had been of copper, except that the soldering process was substituted by electric arc welding. Fig. 6 shows the welding in progress. The bare portion



FIG. 6.—WELDING A JOINT IN THE ALUMINIUM CONDUCTORS.

of the twisted conductors is held near to the base of the twist with a pair of pliers connected to the negative terminal of a portable 24V battery of secondary cells, such as is normally used for lighting jointing chambers. The positive terminal of the battery is joined to a carbon rod electrode which is brought momentarily into contact with the tips of the twisted wires. The passage of the high current melts the ends of the aluminium wires and makes a very satisfactory joint. The carbon rod electrode is

¹Donovan, J. G., and Lanfear, J. S. A New Method of Direct Underground Distribution. *P.O.E.E.J.*, Vol. 46, p. 183, Jan. 1954.

enclosed in an insulating holder, about the size of a fountain pen, which can be seen in Fig. 6 in the right hand of the jointer, and this holder effectively shields the jointer's eyes from the intense light of the arc which forms at the instant of welding.

A specimen of a conductor joint is shown in Fig. 7.

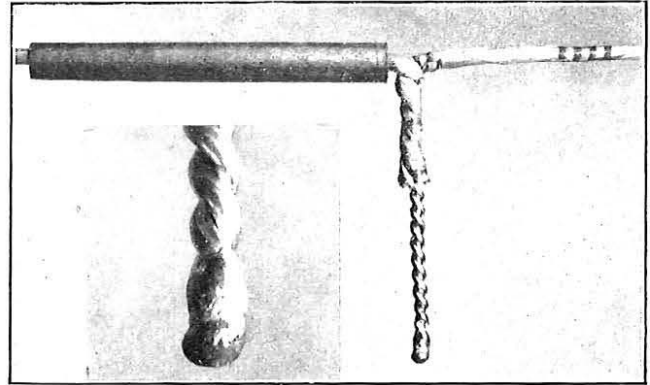

FIG. 7.—A WELDED JOINT.

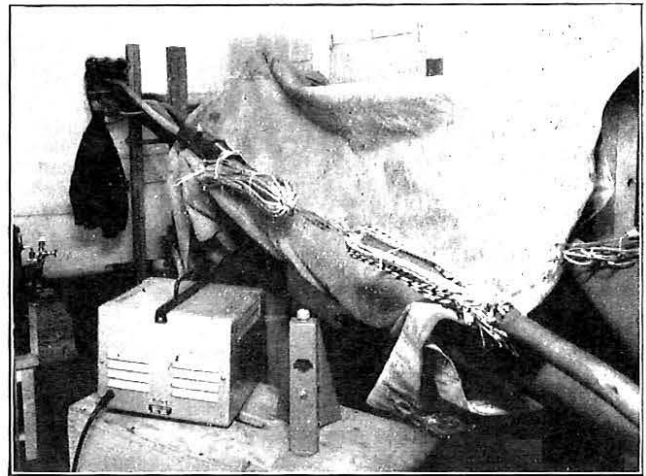

FIG. 8.—ULTRASONIC SOLDERING EQUIPMENT.



FIG. 9.—SOLDERING ALUMINIUM CONDUCTORS TO COPPER CONDUCTORS.

Although the above method of welding is very satisfactory for jointing aluminium wires, it is not completely reliable for joining aluminium wires to copper wires and thus, at the loading points, where the stub cables of the loading pots have copper conductors, the twists were soldered using the ultrasonic method. This equipment is shown in Fig. 8, and a closer view of the vibrating soldering bath in the joiner's hand is shown in Fig. 9.

Sheath Jointing.—The wire joints at each jointing point are housed in a brass sleeve 15 in. long, $2\frac{1}{2}$ in. internal diameter and 0.064 in. thick, instead of in the more usual lead sleeve. This brass sleeve is covered by black expanded P.V.C. sleeving, which when cold slips on easily, but on warming with a blow-lamp flame contracts over the brass to a thickness of about 40 mils. The seal between the brass sleeve and the polythene cable sheath is effectively made by an annular rubber plug at each end which expands radially, inwardly against the polythene sheath and out-

wardly against the inside of the brass sleeve, when four bolts are tightened up to exert pressure on the compression plates. A small brass sleeve, pressed into position under the polythene sheath at the "neck-end" of the cable, provides reinforcement to resist the inward radial pressure exerted by the compressed rubber plug. The P.V.C. covered brass sleeve and one of the rubber plugs sandwiched between its two compression plates can be seen in Fig. 6. The small square visible about half way along the sleeve is where the P.V.C. has been cut away in readiness for local pressure-testing of the joint when complete. The novel features are the use of brass for the sleeve and the expanded P.V.C. covering. Brass was chosen because it is fairly light and relatively cheap and it allowed the easy fixing with solder of the valves for pressure testing or gassing. Bags of silica-gel drying agent are included in each joint.

(To be continued.)

Book Reviews

"Studio Engineering for Sound Broadcasting," A B.B.C. Engineering Training Manual. General editor: J. W. Godfrey. Iliffe & Sons, Ltd. 208 pp. 117 ill. 25s.

While this book has been compiled primarily to assist in the training of B.B.C. technical staff in the operational procedure at B.B.C. studio centres, it contains much that is of interest not only to those performing similar duties in other organisations but also to those concerned with the provision and maintenance of line networks linking such studio centres. It is emphasised in the preface that the manual is intended for both engineering and non-engineering staff and that the technical level is practical rather than academic. Much of the material is descriptive of current practice using particular equipments and operational procedures. The theoretical treatment is suitably limited to the purpose of the book; it outlines the technical principles underlying the design, choice and use of the equipment described and clarifies some of the special problems involved.

The first chapter, of ten pages, explains the requirements of a broadcasting chain and includes an introduction to B.B.C. standard methods, based on B.S. 530, 1948, used in diagrams to represent units of apparatus, components and their values.

The second chapter, 18 pages on transmission quantities, briefly mentions the application of decibel notation to the comparison of voltages across unequal impedances, distinguished from the strict use of the decibel (db) to ratios of powers or ratios of voltages in equal impedances, by the use of the notation db(v). A section is included on the calculation of the voltage gains, in decibels, of amplifiers used under working conditions, with unmatched and unequal input and output impedances, by applying to the insertion gain between 600 ohm source and load, corrections for impedance mismatch and input and output reflection losses. This chapter also includes brief sections on distortion, noise and crosstalk.

The 23 pages of Chapter 3 deal with the acoustics of studios and halls and with the "art" of arranging microphones accordingly and to meet the requirements of different types of programme.

Chapter 4, 21 pages, deals mainly with the requirements of amplifying equipment for specific B.B.C. purposes and describes the types of amplifiers which have been designed to meet them. Assemblies of amplifiers with switching apparatus used for various types of programme sources are covered in Chapter 5 (24 pages). Chapter 6 (25 pages) describes the way in which control centres are equipped and used to receive programme contributions from various sources and direct them to appropriate destinations.

The seventh chapter, of 38 pages, is devoted to programme circuits on Post Office lines and includes brief discussions of transmission on unloaded and loaded lines, carrier phantoms and split-band carrier circuits, noise and crosstalk, delay distortion, the relevant C.C.I.F. specifications, repeaters, the design of constant-resistance equalisers, temperature equali-

sation and circuit test equipment. To this chapter is appended a selection of seven references to textbooks and published papers.

Chapter 8 (13 pages) covers aural, visual and automatic monitoring devices, and includes a section on programme meters.

The final chapter, of 29 pages, deals with telephone and telegraph communication circuits over Post Office private wires between B.B.C. centres throughout the country. The requirements and use of the network are discussed and an account in some detail is included of the various forms of signalling employed, including teleprinter working.

The book is not without a few misprints and errors in the text and the equations, but most of them will be readily apparent to the reader to whom they are of interest. For example: a factor V^2 is missing from the equation at the top of page 23; on page 140 harmonic distortion figures are quoted as 37 db. and 25 db. and are stated to correspond to 0.6 per cent. and 5 per cent. distortion respectively; and in section 7.11.2 (page 159) the output levels of two types of audio frequency line test oscillators are given as 420 db.

A wide field is covered but the treatment, though adequate for many interests, is necessarily brief, and for further details of both technical principles and particular equipments reference is made throughout the text to a number of other B.B.C. engineering training manuals and supplements, and to B.B.C. technical instructions. It is understood that the B.B.C. is prepared to consider supplying copies of particular unpublished references on application to the Editor, Technical Instructions, B.B.C. Studios, Shireland Road, W.9.

F. H.

I.P.O.E.E. Library No. 2045.

"Wireless World F.M. Tuner." S. W. Amos and C. G. Johnstone. Iliffe & Sons, Ltd. 14 pp. 12 ill. 2s.

Now that the B.B.C.'s V.H.F. frequency-modulated broadcasting service is in operation in the London area, and its extension to other parts of the country is imminent, there must be many who are interested in the possibilities of home-construction of suitable receivers.

This booklet, which is a reprint of articles which appeared in the *Wireless World*, takes the reader through the various stages in the design of a tuner unit suitable for feeding an audio-frequency amplifier, and follows the discussion of the basis of the design with full constructional details.

The completed tuner, while perhaps not the most economical design possible, rightly avoids any "tricks" of circuit design and makes no undue demands upon the skill of the constructor. The booklet makes available a sound design which can be recommended to the constructor, and gives an account of design procedure which is in itself of considerable interest.

G. F. S.

The British Post Office Speaking Clock, Mark II*

R. L. SMITH†

Part 2.—Layout, Manufacture and Testing of Equipment, and Packing for Export

U.D.C. 621.395.91

Part 1 of this article dealt with the design and performance of the Speaking Clock, Mark II. This, the second and final part, deals with the general layout of the installation, its manufacture, testing and packing for export.

GENERAL LAYOUT OF THE EQUIPMENT

As stated previously, each installation comprises two complete clocks, together with common equipment and auxiliary power supply. Each clock consists of an Announcing Machine, which is mainly mechanical, together with drive oscillators, amplifiers and correcting apparatus which are almost entirely electronic. This electronic equipment, plus the common equipment (which is also electronic), is mounted on ten 7-ft. high racks. Because of association of function, these racks were bolted together in pairs and electrically interconnected to form five units before leaving the factory. The various items comprising the complete installation at Melbourne (with a similar installation at Sydney) are therefore:—

- (a) Two announcing machines.
- (b) Five pairs of 7-ft. racks carrying electronic equipment.
- (c) Two Time-Signal Generators (mounted, with a control panel, on one table).
- (d) Auxiliary power supply and control panel.

Fig. 4 shows how the first three of these items are arranged in the Clock Room. Item (d) is not shown because it is housed in a separate room. The five pairs of racks of electronic equipment are arranged in a U-formation with

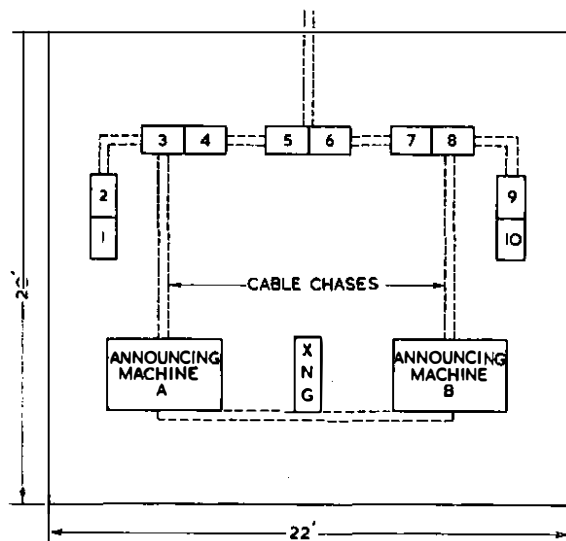

RACK No.	UNIT
1	OSCILLATOR A
2	OSCILLATOR C
3	CLOCK A
4	
5	COMMON EQMT.
6	
7	CLOCK B
8	
9	COMMON OSCILLATOR EQMT.
10	OSCILLATOR B
XNG	TIME SIGNAL GENERATORS

FIG. 4.—LAYOUT OF CLOCK INSTALLATION.

the Announcing Machines and Time-Signal Generators closing the open end of the "U." The racks are equipped with panels on the front only (except for some of the power supply units) and the fronts face inwards, as also do those of the Announcing Machines and Time-Signal Generators. Thus a maintenance engineer standing in the middle of this square formation can observe with ease the various meters, switches, indicator lamps, etc., on the racks, and also the operation of the mechanical equipment, without moving from his central position.

It will be seen from Fig. 4 that Oscillators A and B are mounted on Racks Nos. 1 and 10 and that these are at the ends of the "U." Normally Oscillator A drives Clock A (carried on Racks 3 and 4) while Oscillator B drives Clock B (carried on Racks 7 and 8). Oscillator C (Rack 2) is normally spare and may be used to drive either clock if Oscillators A or B should fail. The changeover is accomplished by plugs and sockets on Rack No. 9, which also carries the Monitor and Alarm equipment for all three oscillators. The two racks of Common Equipment (Nos. 5 and 6) are conveniently placed between Clocks A and B. It will also be seen that Announcing Machine A is placed opposite the electronic equipment of Clock A, while Announcing Machine B is opposite that of Clock B, the Time-Signal Generators being between the two Announcing Machines. An engineer starting up or making adjustments to either Announcing Machine is therefore able, merely by turning his head, to observe the results on the indicating instruments on the appropriate racks. He may also listen to the announcement on loudspeakers which are mounted at the top of racks Nos. 1 and 10 and which can be switched independently to monitor various points in the system. The whole makes a pleasingly symmetrical arrangement of the two clocks about the common equipment.

It will be noticed that spaces have been left between the pairs of racks and also that there is what may appear to be waste space between the racks and the machines. The reasons for this are threefold. Firstly, it adds to ease of maintenance; secondly, it minimises fire risk; and thirdly, it allows a reasonable number of people to see the installation at one time. The last reason is important since the equipment obviously has exhibition value, because these are probably the most accurate Speaking Clock Installations in the world.

Arrangement of the Panels on the Racks.

Certain general principles have been adopted in arranging the panels on the racks. These are:—

- (a) No panels carrying controls or indicating instruments are mounted on the rear of the racks. In fact, only power supply panels are thus mounted, and this has been done only on racks where the front is already fully occupied.

* This article was published in the Telecommunication Journal of Australia (Vol. 10, No. 2, Oct. 1954) and is reproduced by kind permission of the Editor of that Journal.

† Formerly Line Transmission Department, Telephone Manufacturing Co., Ltd., St. Mary Cray, Kent, England, now with E.M.I. Engineering Development, Ltd., Wells, Somerset, England.

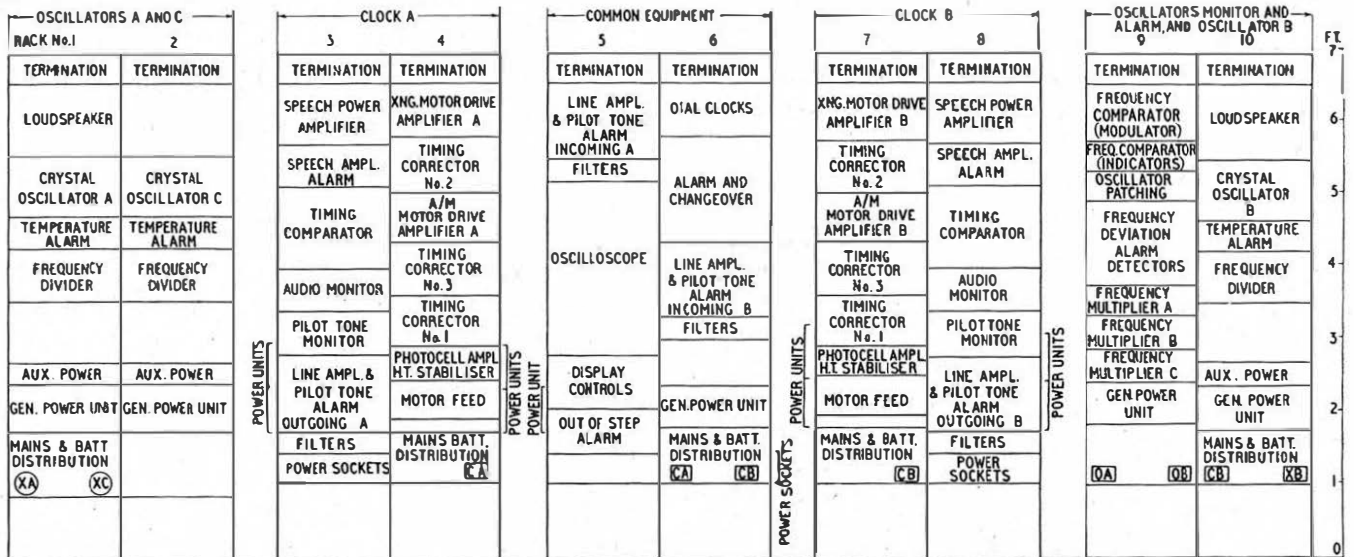

FIG. 5.—ARRANGEMENT OF THE PANELS ON THE RACKS.

- (b) All power supplies (230V A.C. and 50V D.C.) enter the racks via Mains and Battery Distribution Panels which are located at the bottom of the racks, there being one such panel for each pair of racks. These panels carry switches, fuses and neon indicator lamps for the mains input to the individual power units together with rack-isolating switches. They also carry fuses for the 50V D.C. supplies to the various panels and to the announcing machines.
- (c) All 230V A.C. wiring has been run in conduit to reduce fire risk.
- (d) All other electrical connections to the racks are made via Termination Panels, which are located at the tops of the racks. These panels carry tag blocks for the D.C. and audio frequencies and coaxial connectors where radio frequencies are involved. One Termination Panel is provided per rack.
- (e) As far as possible, panels carrying indicating instruments have been grouped at eye level. No panel is closer to floor level than one foot.

Fig. 5 shows the layout of the panels on all ten racks. The Oscilloscope Panel is perhaps worthy of special mention since it is basically different from the other panels. It consists only of a metal hood, sprayed matt black inside and fitted with doors at the front. There is an aperture at the rear of the hood through which the front of a standard double-beam oscilloscope projects. For normal use the oscilloscope, which is mounted on a trolley, is connected to the clock installation by a plug and socket. By means of

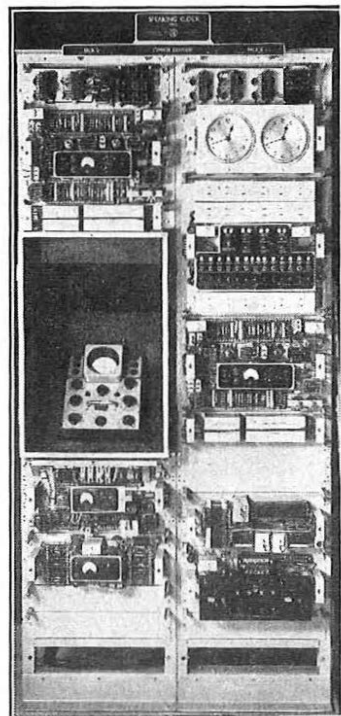

FIG. 6.—COMMON-EQUIPMENT RACKS, WITH COVERS REMOVED.

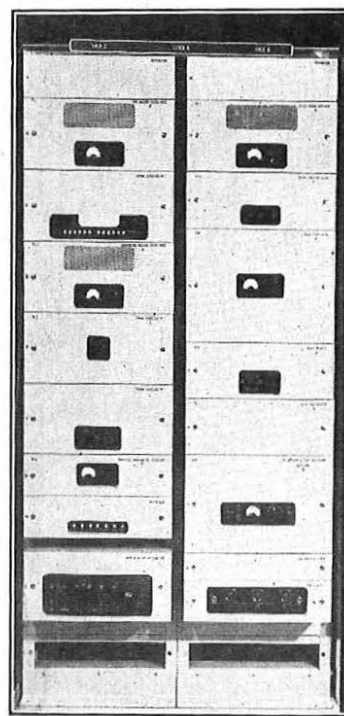

FIG. 7.—CLOCK B.

controls on the panel situated immediately below the Oscilloscope Panel, simultaneous displays of two waveforms at various points in the system, or the progress of a timing correction, may be followed. If the oscilloscope is required for fault tracing in other parts of the equipment, it may be easily unplugged from the rack, wheeled out of its hood and brought round to the front of the equipment for use in the normal manner.

Fig. 6 shows the two racks of Common Equipment with the Oscilloscope in position, but with the doors removed, and the covers of the other panels also removed. Fig. 7 shows the two racks of Clock B with the covers in position.

Panel Design.

The principle of ease of maintenance has also been dominant in the design of the individual panels. To this end, care has been taken that no component is obscured by another component and all soldering tags have been made easily accessible for the measurement of voltages, resistances, etc. It became obvious, when designing some of the panels, that a meter and its associated wafer switch made compliance with this principle extremely difficult without considerable waste of panel space. The difficulty was solved by hinging the switch and meter sub-panel so that it could be swung out of the way for maintenance purposes. Fig. 8 illustrates this in the case of the Timing Comparator Panel.

In general, electrical connections to panels have been made via soldering tags carried on blocks at each end of the panel, the left-hand block being

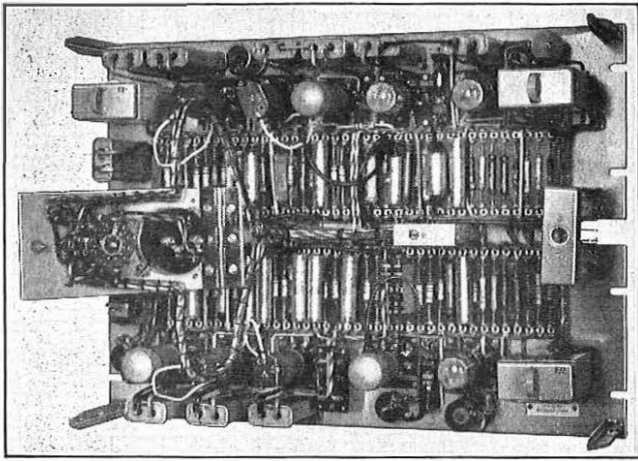

FIG. 8.—TIMING COMPARATOR PANEL, SHOWING METER SUB-PANEL.

used for signal wiring and the right-hand block for power wiring. A standard arrangement was used so that on any panel the same supplies would always be found on the same tags. Thus, H.T. always appears on tag 1 with the negative on tag 3; 6.3V A.C. for valve heaters always appears on tags 4 and 6; 50V negative on tag 11 and so on. For the wiring of the panels, 22 S.W.G. tinned copper wire covered with insulating sleeving has been used almost throughout. By using both striped and plain coloured sleeving a total of 17 different colours was available and these were used to designate the functions of the various leads. For example, input leads are green, grid leads white, anode leads yellow, H.T. red, earth black and so on. The use of this colour coding was of considerable assistance during the testing of the panels and it is believed that it will be very helpful during maintenance and fault finding.

All components were chosen to withstand the tropical conditions likely to be encountered on the sea voyage to Australia, even though, as described later, precautions to minimise the effects of these were taken in the packing.

FEATURES OF MANUFACTURE AND TESTING

When manufacture of the Melbourne installation was begun by the Telephone Manufacturing Co., the design of the whole equipment (which was the responsibility of the British Post Office) was not complete. As a consequence, it was necessary to alter or remake certain parts that had already been manufactured in order that they would work satisfactorily with parts subsequently designed. It also became obvious, as the system was built up, that additional facilities were desirable and this, of course, demanded the design and manufacture of extra parts. All this involved close co-operation between the British Post Office and the Telephone Manufacturing Co., and to this end two of the company's engineers and two of its draughtsmen spent several months at the British Post Office Research Station before and during the early stages of manufacture, while two Post Office engineers spent some months on the company's premises during the testing stage. The situation was complicated by the fact that the mechanical part of the installation was made in one Telephone Manufacturing Co. factory, while the electronic part was made in another. The auxiliary power supply was made by an entirely separate contractor and the Time-Signal Generators by yet a third contractor.

For testing purposes it was essential to bring all these items together in one place and to interconnect them electrically.

The equipment, although rather elaborate in conception, is straightforward in design and based on well-established principles. It did, however, call for a few manufacturing

and testing techniques and facilities not normally available in a company manufacturing the more conventional items of telecommunications equipment, and some of these will now be mentioned.

The Drive Oscillators.

These were expected to have, and in fact did have, a stability of 1 part in 10^8 per day once the crystals had settled down. In order to check this it was necessary to have a 100 kc/s reference frequency which had a day-to-day stability of at least one part in 10^9 and whose daily drift was constant and predictable. No such stable frequency was available when manufacture was begun and the first job was to provide one. This was achieved by building an oscillator identical with the clock oscillators but using a clamped GT-cut crystal and installing this in a vibration-free room, the temperature of which was thermostatically controlled at $30^\circ \pm 1^\circ\text{C}$. Standby power supplies were provided for this oscillator and these came into action immediately and automatically if the mains failed. The oscillator was thus run continuously; after six months its drift rate had dropped to a few parts in 10^9 per day and after one year's running to 1 part in 10^9 . It is of interest to note that after two years' continuous running the daily drift rate was 8 parts in 10^{10} . This sub-standard oscillator was checked daily against standard frequency transmissions received by radio from Rugby, and provided by the National Physical Laboratory. By this means not only could the day-to-day stability of the clock drive oscillators be checked under ordinary room conditions but their performance at extremes of temperature and supply voltage could also be assessed.

The Frequency Comparator Panels.

As stated in Part 1 of this article, three oscillators are provided, the frequencies of which are continuously compared with each other, and the total differences displayed on a scale-of-ten indicator similar to a kilowatt-hour meter. This meter is driven by a small three-phase motor operating at the beat frequency of a pair of oscillators. It was necessary to test these motors (which were a purchased item) before a pair of oscillators was available. This was accomplished by using one oscillator and a delay line giving known amounts of delay in multiples of 30° . The direct 100 kc/s signal and the delayed signal were then fed to a modulator and the output of this fed to the motor via a phase-splitting network. By changing the taps on the delay line, rotations in 30° steps could be obtained.

The Announcing Machines.

The manufacture of the units comprising the announcing machines presented a number of individual machining problems involving extreme limits of accuracy. The bedplate upon which the various units are mounted consists of a very stable aluminium alloy casting of thick section, strongly webbed on the underside and weighing nearly 2 cwt. The top surface measures 46 in. by 30 in. and has been machined so precisely that a feeler gauge 0.002 in. thick will not pass under a straight-edge placed anywhere upon it. The four cams which control the positions of the photocell/lens systems in relation to the sound tracks on the speech discs are made of Nitralloy steel and these, like the feed ratchets on the camshafts, are hardened to a degree approaching that of sapphire. The essential steps cut round the edges, upon which the follower rollers bear for operating the carriage-shift mechanisms, are highly burnished and finished within ± 0.001 in. of the theoretical radius. Fig. 9 shows two of these cams together with the pawl and ratchet mechanisms and the electromagnet for operating the clutch.

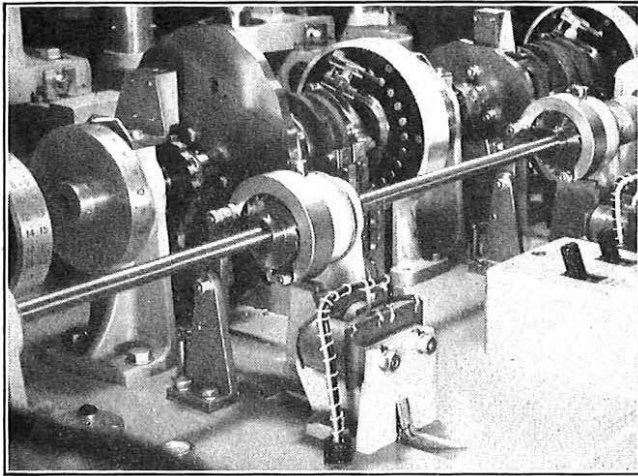

FIG. 9.—HOURS AND SECONDS CARRIAGE-SHIFT MECHANISM.

The 1-in. diameter shaft carrying the speech discs is made of nickel-chromium steel and finish-ground within ± 0.0001 in. of nominal size. The motor shaft turns at a speed of $166\frac{2}{3}$ revolutions per minute and a two-stage reduction gear produces the final output speed of 30 R.P.M. at the speech disc shaft. Precision-cut helical gears with finely-lapped teeth are employed for this purpose. The accuracy of these gears is of a high order, as shown by the following figures:—

Backlash between any intermeshing pair: 0.0008 in. to 0.0014 in.

Pitch circle concentricity: variation ± 0.0003 in. to ± 0.0012 in.

Pitch error: Maximum deviation on 36-tooth pinion, 0.0001 in.; on 60-tooth gear, 0.0002 in.; and on 120-tooth gear, 0.0004 in.

Two devices are incorporated to ensure the smoothest possible transmission of power from the main motor shaft to the speech disc shaft. The first of these is a torsion bar which links these two shafts and which, by virtue of its mechanical compliances, smooths out the 50 c/s component of the motor torque. The second is a fluid flywheel, which is mounted on the motor shaft. This prevents motor hunting and also effectively damps any mechanical resonance there may be in the torsion-bar/disc-shaft combination which might be excited by remanent gear irregularities. Frictional losses are minimised by the use of specially-selected ball races throughout the motor and gearbox unit, the fluid flywheel and the disc shaft pedestals. The highest degree of precision on spindle diameters and bored holes for housing the bearings was demanded. Machining limits of the order of 0.0003 in. had to be specified in these instances, calling for very careful selection and fitting in the assembly stages.

The method of checking the rotational stability of the system is interesting. One of the speech discs was replaced by a disc carrying a 1 kc/s sound track and the output obtained from this, when scanned by the optical system, was displayed on one beam of an oscilloscope. On the other beam was displayed a 1 kc/s trace obtained from the frequency divider driving the motor. Any rotational irregularities were thus shown up and could be measured easily. With careful attention to the points mentioned above these were reduced to less than ± 1 millisecond.

The satin-chrome finish used on all external brass and steel components (except the shafts) presents a pleasing appearance in contrast with the grey stoved-enamel surface of the various cast parts. Both processes required careful preliminary treatment of the machined items to ensure the results achieved on the finished job.

A steel cover with four glass windows keeps dust from

the equipment whilst giving an adequate view of the whole machine. Ventilation is provided by four openings in the lower part of the cover and a louvre at the top; the lower ventilating holes also providing a means of gripping the cover when removing it. The four glass panels are individually removable and are secured normally by a lock.

The base of the announcing machine also mounts an amplifier panel containing seven cathode followers (one for each photocell) and a mixer. This ensures that the signals obtained from the glass discs are fed to the main amplifiers on the racks at a reasonably high level and a low impedance. As a result of this, the announcing machines may, if required, be placed at a considerable distance from the racks. A door in the left-hand end of the main cover gives access to the controls of this panel. Fig. 10 shows a complete announcing machine with its cover in position, and the cathode follower panel may be seen at the left of the illustration.

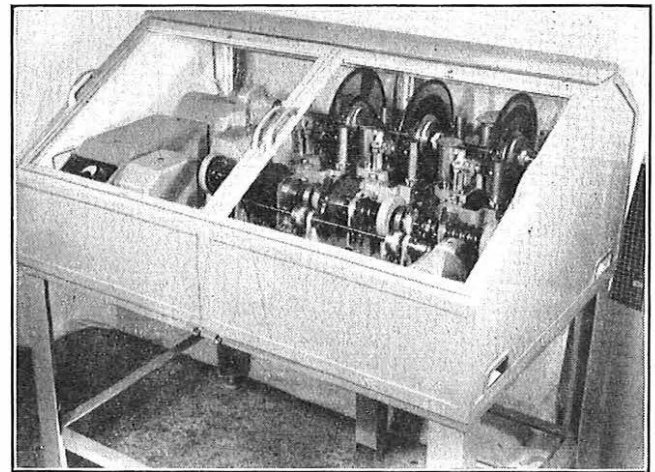

FIG. 10.—ANNOUNCING MACHINE.

Glass Disc Records.

The manufacture of these, which was undertaken by the British Post Office, will not be described here as an account of the process has already been given.¹

Fig. 11 shows the hours and seconds discs mounted on the shaft, together with the exciter lamps and photocells.

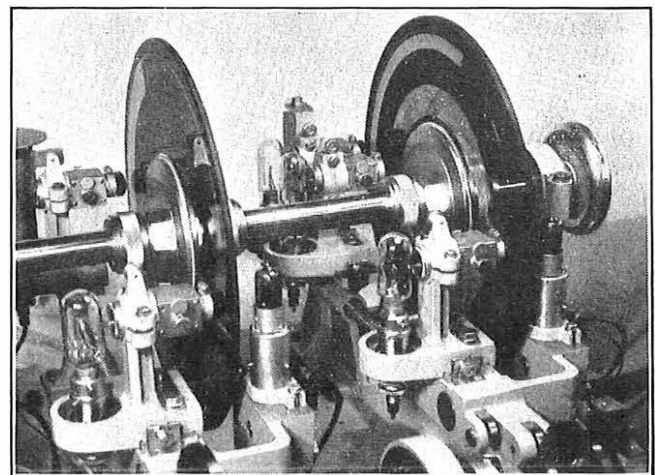

FIG. 11.—TWO OF THE GLASS DISC RECORDS.

Performance Testing.

To assess the performance of the clock, and to make sure that the correcting equipment operated satisfactorily over

¹ Forty, A. J. A Photographic Technique of Sound Recording on Glass Discs. *P.O.E.E.J.*, Vol. 47, p. 19. Apr. 1954.

a period of weeks, time signals were received over a telephone line from the Royal Observatory at Abinger, Surrey, England, and these were used for the daily correction of the clock during its trial run. Tests of the correcting mechanism when operated by signals received over a 400-mile carrier line were also made.

PACKING FOR EXPORT

Packing depended upon three main considerations:—

- (i) The delicacy of certain parts of the equipment.
- (ii) The deleterious effects of moisture.
- (iii) The effects of vibration on adjusted components.

An additional reason for extra care in packing was that most of the components had been individually manufactured, and that spares would not be immediately available but were to be shipped later. It was also important to preserve the fine finish of the equipment. It was therefore decided to adopt the following principles in packing:—

- (a) The case or crate should securely grip the article to be packed. This case would then be "floated" on a suitable resilient material, such as rubber or wood wool, within an outer container or containers, dependent upon the fragility of the item.
- (b) A moisture barrier should be introduced between the article and the inner case.
- (c) The outer case should be protected from weather and sea-water by a moisture-proof lining. This is important since water entering the outer case could damage the resilient packing material.

The packing of the Time-Signal Generators illustrates the above considerations and is typical of the 42 packages which made up the complete shipment.

Fig. 12 illustrates the Time-Signal Generators in their close-fitting case, which was lined throughout with the moisture-insulating material. This material was crêped kraft interleaved with bitumen, having all joints sealed with "Bostik"; crêped kraft is elastic and does not split if the case becomes distorted under stress. The machines were held firmly in position by felt-faced wood blocks. Before sealing this box, a suitable quantity of silica gel in bags was put in to absorb moisture from the air in the box.

After fixing the lid, the box was wrapped in metal foil sandwiched between two kraft sheets, one of which was coated with polythene. The sheets were then sealed by

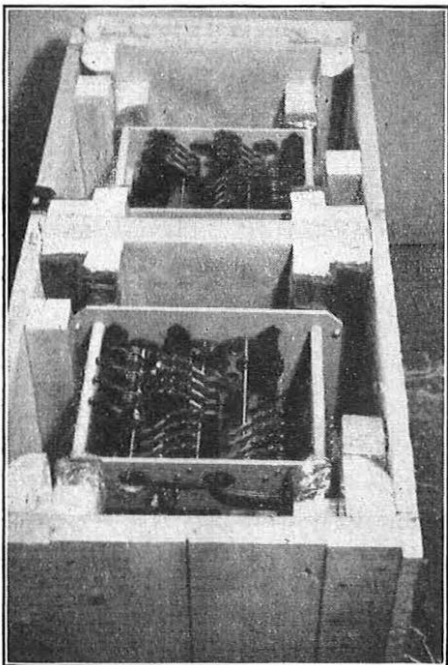

FIG. 12.—TIME-SIGNAL GENERATORS IN THEIR CLOSE-FITTING CASE.

fusing the polythene with a hot iron.

The second case, the overall dimensions of which were 3 in. greater than those of the first, was also lined with the moisture-insulating material and sealed with "Bostik." It was then "floated" within the outer case by means of blocks composed of a mixture of rubber and fibre.

The third and final packing case was 6 in. larger than the second in all dimensions. This was lined and sealed as the others and case No. 2 "floated" inside it, this time by means of wood wool, as shown in Fig. 13.

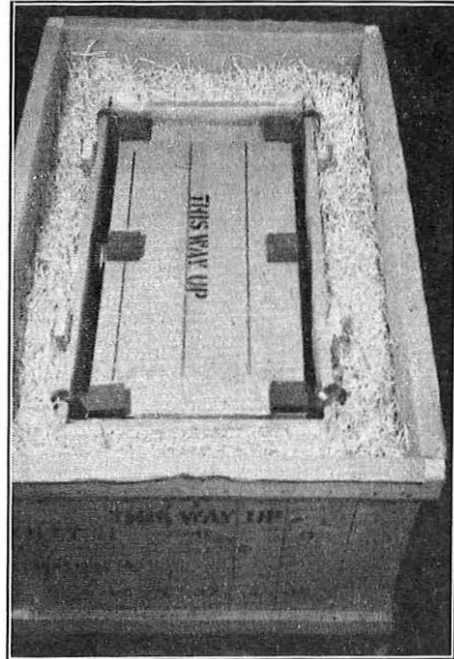

FIG. 13.—INNER CASE "FLOATING" WITHIN TWO OUTER CASES.

The lids of all cases were lined with crêped-kraft moisture-insulating material with sufficient overlap for them to be sealed to the main case lining when closed.

The Quartz Crystals.

Owing to the extreme susceptibility of the quartz crystals to mechanical shock, they were flown to Australia.

The crystals were mounted in the double-walled ovens in which they are housed in the oscillators and these ovens were carried in a special container lined with thick sponge rubber, two ovens being accommodated in one carrying box. In spite of these precautions, of the 10 crystals thus sent, one was damaged in transit.

Spare Parts.

All spare parts were individually packed in such a way that they would remain in good condition over a long period. Bearings were oiled before wrapping and other items were protected by corrugated cardboard. Each part was then closely wrapped in waxed paper and placed in a transparent polythene bag. An identification label placed therein was clearly visible through the polythene. Air was extracted from the bags, which were then heat-sealed to eliminate the danger of sealing the item in a moist atmosphere. The bags were then packed in wooden cases.

This method of packing enables a store-keeper to identify each component by its appearance and by its label without opening the protective wrapping.

CONCLUSIONS

It is as yet too early to say whether the method of packing the spare parts has achieved its objects but both installations arrived in Australia in excellent condition and are now operating satisfactorily.

The Provision of Circuits for Television Outside Broadcasts

M. B. WILLIAMS, B.Sc.(Eng.), A.M.I.E.E.,
and J. B. SEWTER, A.M.I.E.E.†

Part 2.—Injection of Vision Signals at Intermediate Points on Main Cable Links

U.D.C. 621.395.97 : 621.397.24

The provision of line circuits for video transmission of television signals between the site of an outside broadcast and the point of injection of the signals into a main television link was described in Part I. This article, Part 2, describes two types of equipment used for injecting vision signals into main coaxial-cable television links which are operated in the frequency ranges 3·7 Mc/s and 0·5-4 Mc/s.

INTRODUCTION

OUTSIDE Broadcast (O.B.) injection equipment is provided for use on the main cable television links, its purpose being to extend the scope and range of television outside broadcasts by permitting O.B. line or radio links to be connected to a convenient intermediate point on a main link to a switching centre (a "Contribution" link). Two types of this equipment exist at present: one for Coaxial-Equipment, Line (C.E.L.), No. 3, which operates at 3·7 Mc/s¹ and is used on the Birmingham-London link; the other for C.E.L. No. 4, which operates at 0·5-4 Mc/s^{2, 3, 4} and is used on the Wenvoe-London and Manchester-Birmingham links employing Equipments, Frequency-Translating Nos. 7A and 8A.

Each set of equipment is essentially a transportable transmit terminal station and has been designed to give the following facilities:—

- (a) It is as portable as possible while, at the same time, using existing patterns of the essential panels.
- (b) It is completely self-contained, having normal and stand-by transmission equipment and all necessary testing and monitoring equipment.

†The authors are, respectively, Senior Executive Engineer and Executive Engineer, Transmission and Main Lines Branch, E.-in-C.'s Office.

¹For numbered references see end of article.

- (c) No change is required at the receive terminal station when an injection is made at an intermediate station; all correction and equalisation for the new conditions are made at the injection point so that the signal level and quality at the receive terminal is substantially the same whatever the origin of the signal.
- (d) For simplicity, the changeover from normal to stand-by equipment is made by manual operation of links, cords or keys; the injection station is necessarily staffed during a broadcast.
- (e) The injection equipment incorporates a changeover relay system giving INJECT or THROUGH conditions. The equipment is normally patched into the main line outside programme hours and can be rapidly brought into circuit by operation of the changeover relays, either locally or remotely over a suitable control circuit.
- (f) The line pilot, or its equivalent, used to control the automatic changeover of line amplifiers at intermediate stations is maintained throughout the line during injection.

The injection equipment sets are normally held at centres where Post Office mobile teams have been set up, i.e., London, Birmingham, Manchester and Cardiff, and are transported to site when required. A special test van⁵ is

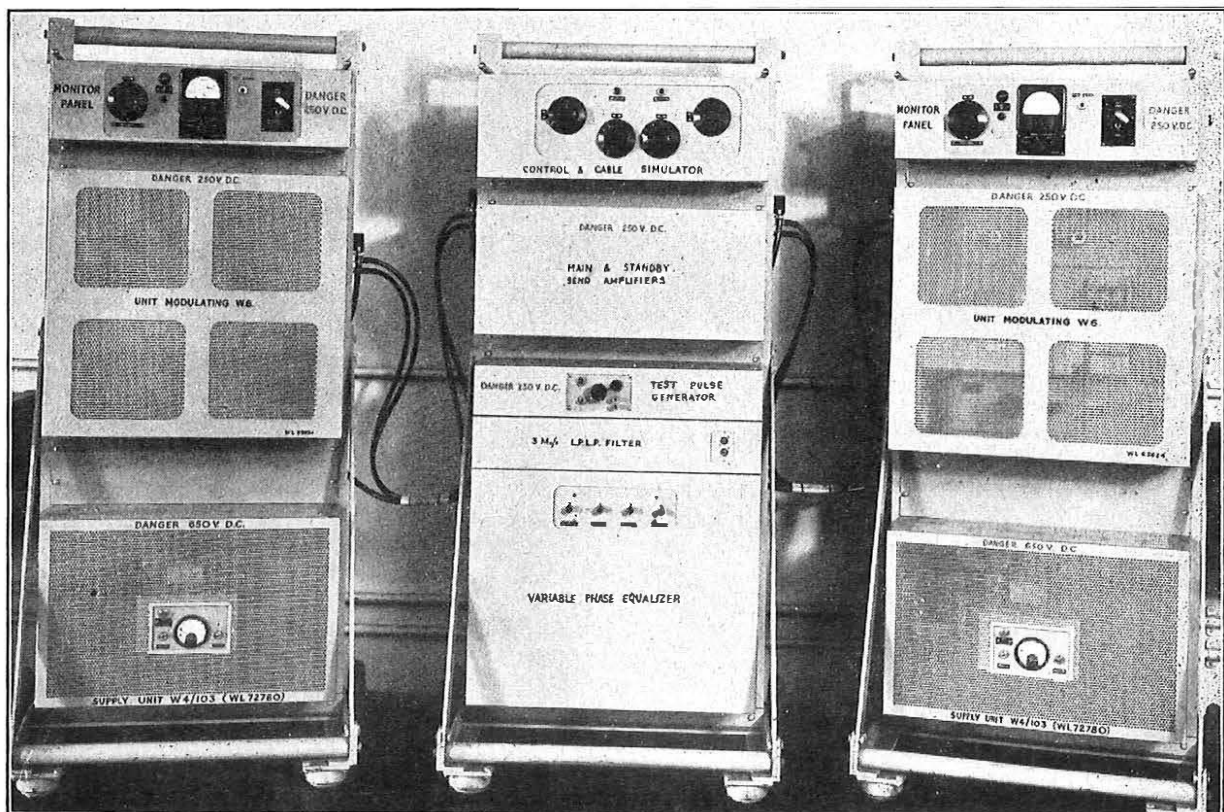
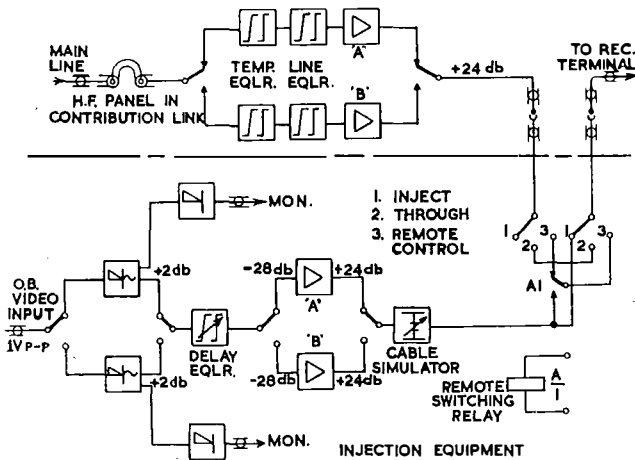

FIG. 7.—3·7 Mc/s INJECTION EQUIPMENT.

required for the 0.5-4 Mc/s type of equipment, which is much larger than the 3-7 Mc/s equipment. It has been found difficult to operate the equipment in the vehicle, and it is normally unloaded and set up and operated by the mobile teams in the repeater station in a position adjacent to the line equipment.

3-7 Mc/s INJECTION EQUIPMENT

Fig. 7 shows a complete set of C.E.L. No. 3, 3-7 Mc/s, injection equipment, and a simplified block schematic diagram of the equipment is given in Fig. 8. The equip-



Levels indicated are relative to 1 mW, with unmodulated carrier.

FIG. 8.—BLOCK SCHEMATIC DIAGRAM OF 3-7 Mc/s INJECTION EQUIPMENT.

ment will inject at any one of the 11 equipped stations, spaced 12 miles apart, or at any one of 38 unequipped stations, at 3-mile intervals between equipped stations, between Sutton Coldfield and Alexandra Palace. On this link the overall delay distortion of the line system is equalised at the transmitting terminal; but each repeater section is equalised individually for the cable attenuation. The injection equipment, therefore, is provided with variable delay-equalisers which can be set to predetermined combinations of four single, key-controlled sections and a single "trimming" section to equalise the length of link between the injection point and the receiving terminal to approximately the same extent as the full line is normally equalised. The target for any injection point is that the delay distortion over the 3-7 Mc/s range should not exceed $\pm 0.14 \mu\text{s}$. Injections made at the equipped, 12-mile spaced, repeater stations require no correction for attenuation equalisation, but injections at the unequipped, 3-mile spaced, points require that the incomplete repeater section should be built out to equal the actual length of the section. This is done by means of a variable cable-simulator controlled by two six-position switches. The COARSE control simulates the attenuation/frequency characteristics of 0, 1.5, 3.0, 4.5, 6.0 and 7.5 miles of 0.975-in. coaxial cable; the FINE control has steps equivalent to 0.25 miles, up to 1.25 miles total. Fig. 9 shows the simulator characteristics. The variable delay-equaliser (or phase-equaliser), the variable cable-simulator, a main and stand-by transmit line amplifier with power unit, control and test facilities are mounted together on a small wheeled rack, shown in the centre of Fig. 7.

The modulator and its power unit are identical with those used in the main line terminal stations, a fixed delay-equaliser and an amplifier being included. This equipment, plus a monitor panel incorporating a simple test demodulator, is mounted on a similar small wheeled rack. Two such racks are provided to give working and

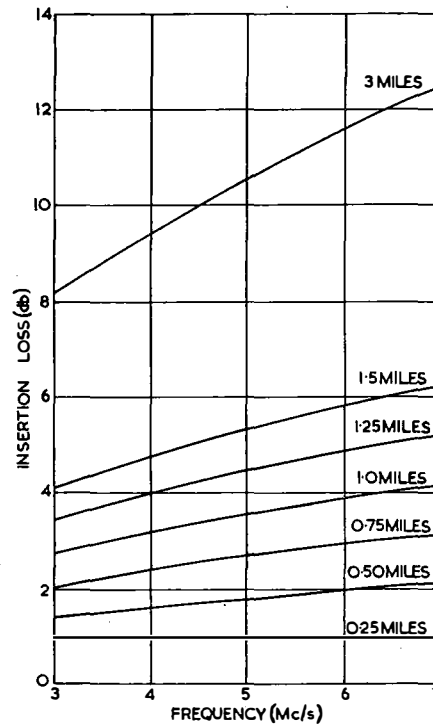

FIG. 9.—INSERTION LOSS OF 3-7 Mc/s VARIABLE CABLE-SIMULATOR.

stand-by facilities. The assembly of modulator and line racks ready for use is shown in Fig. 7. The automatic changeover of the line amplifiers in the 3-7 Mc/s line system is under the control of the 6.12 Mc/s carrier transmitted from the modulator and, depending upon whether the injection equipment is set to INJECT or THROUGH, this signal is obtained either from the injection modulator or the remote modulator; thus normal operation of all intermediate line amplifiers on the link is maintained.

In addition to the equipment carried on the three portable racks, each set of injection equipment is provided with a picture monitor, video oscillator, high-speed oscilloscope, general-purpose oscilloscope, wide-band decibelmeter, variable mains transformer and multi-range meter. The total weight of an injection set is about 7 cwt.

Operation.

The equipment is set up at the injection point, connected to a mains supply, and tested on an in-station basis. The unmodulated carrier level at the output of the modulators is adjusted, and the depth of modulation is then set to be 33 per cent., observed visually on an oscilloscope, for a 1V peak-to-peak video input signal. The delay-equaliser and cable-simulator sections are adjusted to predicted settings. With the agreement of the Receive Control Terminal of the link, the equipment is connected into the contribution link outside programme hours. If the injection is at a 3-mile station on a power feeding section, appropriate safety precautions are taken.

Tests between the injection point and the Receive Control Terminal are then carried out. Checks are made at the Receive Control Terminal of carrier level, depth of modulation and, by bringing a demodulator into circuit, the waveform response. A satisfactory waveform response should be obtained if the delay-equaliser and cable-simulator adjustments have been correctly carried out.

Fig. 10 shows waveform responses from Gladstone Repeater Station (the second 3-mile station from London) and Silverstone Repeater Station (a 3-mile station within the seventh 12-mile repeater section from London) as received at Museum Exchange in London.

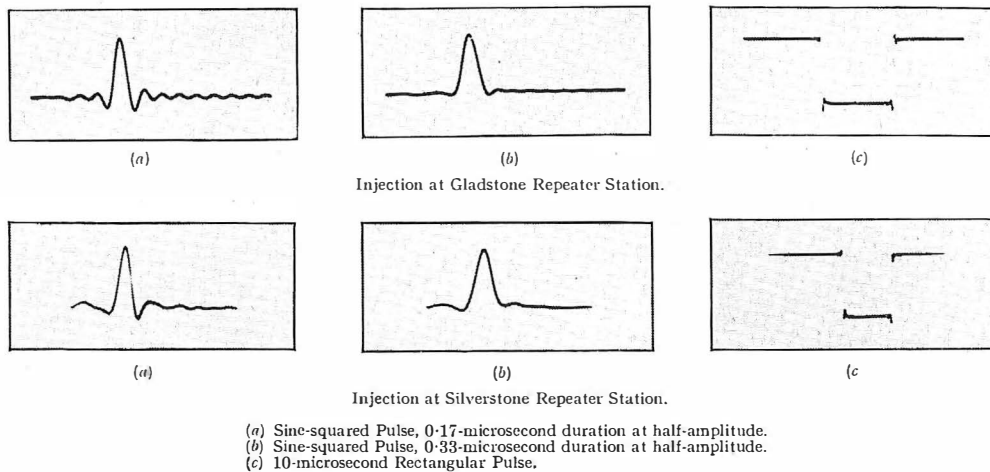

FIG. 10.—WAVEFORM RESPONSES OF 3-7 Mc/s O.B. INJECTION CIRCUITS ON THE BIRMINGHAM-LONDON COAXIAL-CABLE LINK.

Finally, a picture monitor is connected to the video output at the receiving terminal and the performance is checked subjectively, especially for freedom from R.F. pattern and other interference. The switching facility, with any remote-control circuit associated, is checked and the link handed over to the B.B.C. for use. Any associated line or radio O.B. link will have been lined up and proved independently; after connection to the injection circuit, overall tests are made by the B.B.C.

During a broadcast, or previous tests, the injection equipment is continuously monitored by means of the monitoring demodulator and a picture or waveform monitor.

0.5-4 Mc/s INJECTION EQUIPMENT

Although vestigial-sideband transmission in the 0.5-4 Mc/s line-frequency range, with the carrier at 1.056 Mc/s, is an international standard system for $\frac{3}{8}$ in. coaxial cables, the form of the modulated signal and the operating conditions on the line are not specified. Consequently, the existing injection equipment is suitable only for the Manchester-Birmingham or Wenvoe-London links for which it was designed, although other 0.5-4 Mc/s television links exist or are envisaged. As in the 3-7 Mc/s injection equipment, the modulator units are identical with those used at the terminals of the main-line system, but an

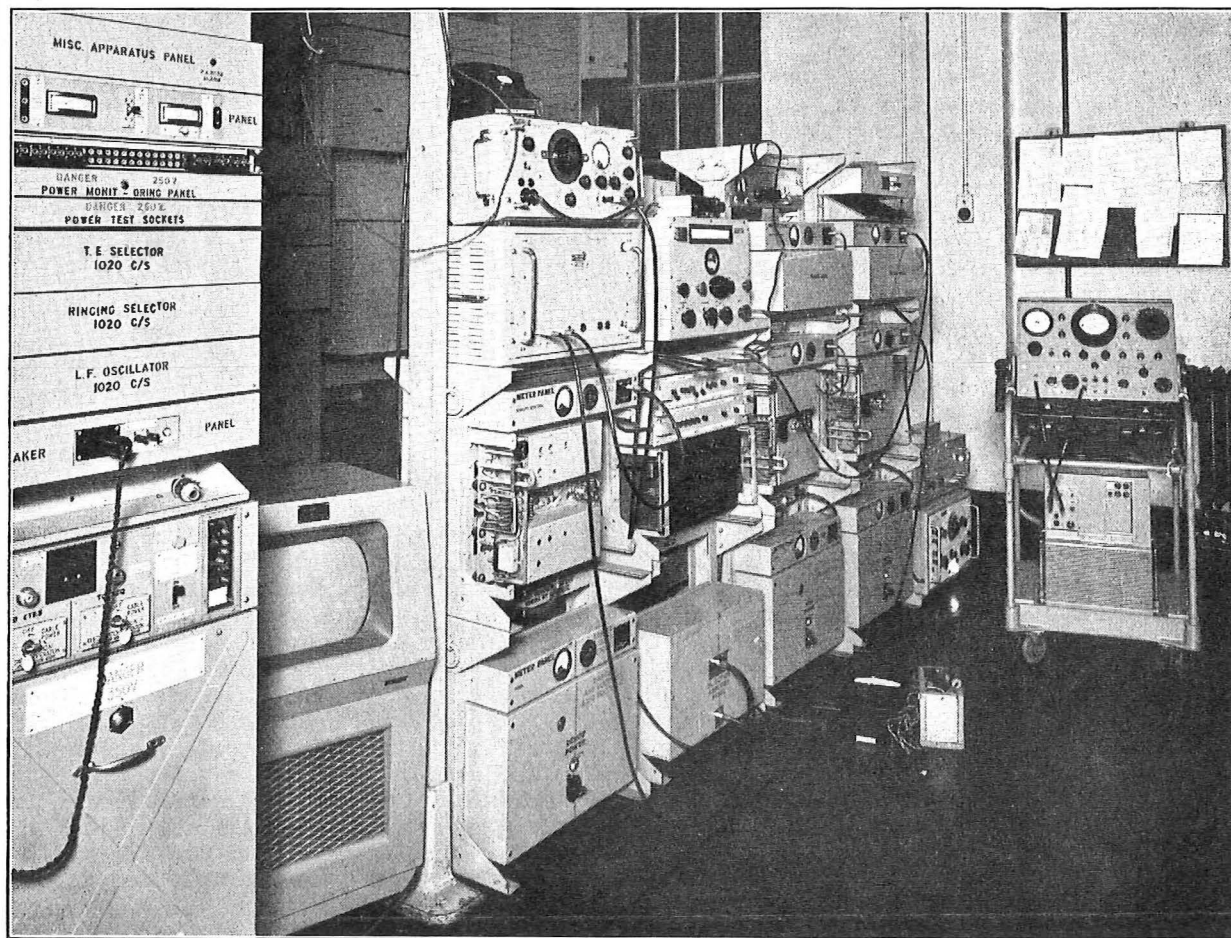

FIG. 11.—0.5-4 Mc/s INJECTION EQUIPMENT.

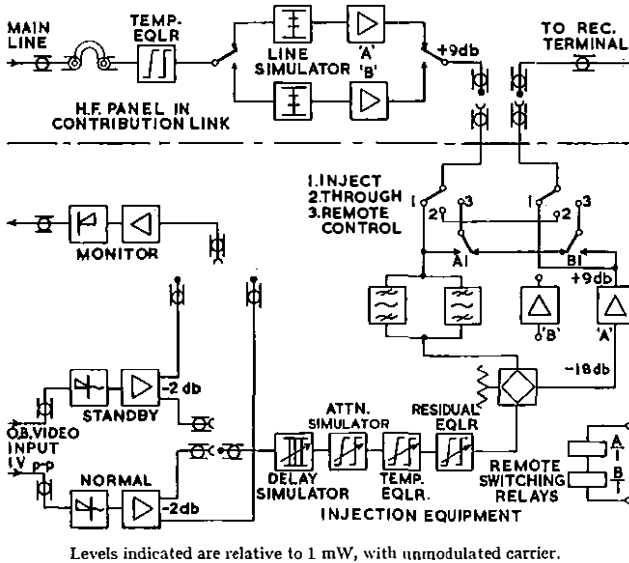

FIG. 12.—BLOCK SCHEMATIC DIAGRAM OF 0.5-4 Mc/s INJECTION EQUIPMENT.

entirely new line simulator, equaliser, switching and filter equipment was required for the 0.5-4 Mc/s injection equipment.

A photograph and a simplified block schematic diagram of the assembled equipment are given in Figs. 11 and 12; due to the complexity, great weight (approximately 17 cwt.) and bulk of the equipment it has been broken down into small units carried on 10 stackable racks, comprising:—

- Two modulator racks (working and standby)
- Two transmit amplifier racks (working and standby)
- Two modulator power racks (working and standby)
- One demodulator rack (for testing and alignment)
- One demodulator power rack
- One line simulator, equaliser, switching and filter rack
- One injection amplifier rack (comprising working and standby line amplifiers and power unit).

In addition, there is a comprehensive set of test and monitor equipment for the waveform and steady-state measurements normally made on this equipment at the terminal stations, and three electronically-stabilised 1 kVA mains regulator units, required to give satisfactory operation on unregulated local power supplies.

Equalisation Adjustment.

On the C.E.L. No. 4 line links, injection is possible only at the repeater stations, nominally 6-mile spaced, but as there are many more equipped repeater stations than on the C.E.L. No. 3, 3.7 Mc/s, system discussed previously, some compensation for departures from perfect attenuation equalisation at each station is required. Furthermore, the overall delay equalisation, as well as residual attenuation equalisation, is carried out at the receiving terminal. The injection equipment therefore requires:—

- (a) a repeater-section delay-distortion simulator,
- (b) a repeater-section attenuation-distortion simulator,
- (c) a line residual equaliser, and
- (d) a line temperature equaliser.

The attenuation-distortion simulator and line residual equaliser were designed with a knowledge of the systematic deviations encountered on the two cable links concerned. The attenuation-distortion simulator comprises sections which approximate to the systematic deviation of 0, 4, 8, and 8 repeater sections. The line residual equaliser, in addition to simulating from 1 to 3 repeater sections, provides the residual attenuation equalisation not supplied by the

4-section or 8-section simulators. The circuit consists of 16 constant-resistance bridged-T sections in tandem, the frequencies of peak loss being in the ratio of 1 : 1.18 and ranging from 403 kc/s to 4,840 kc/s. The 14 intermediate sections from 476 kc/s to 4,100 kc/s have pad losses* adjustable in steps of 0.2 db. from 1.0 db. to 3.0 db. The two end sections have fixed pad losses of 2 db. and characteristics somewhat different from the remainder. With all sections set to 2.0 db. the total loss over the band is 6.0 ± 0.1 db.; the frequencies of the peaks are shown in Fig. 13.

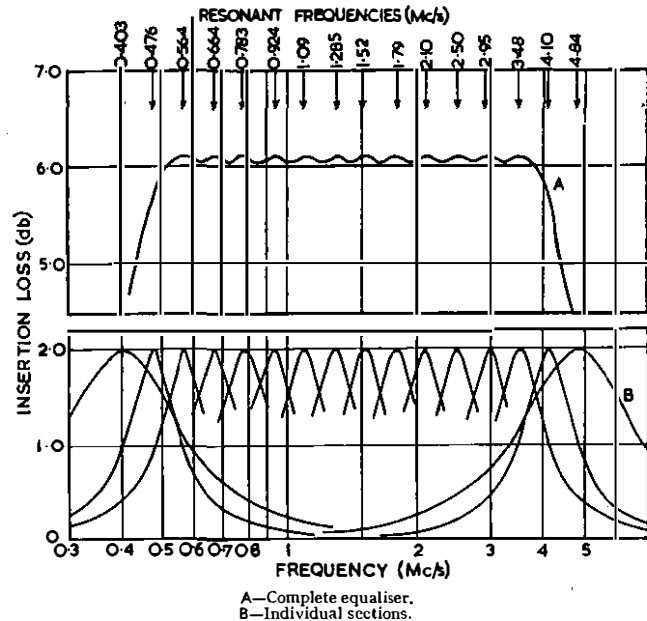

FIG. 13.—INSERTION LOSS OF 0.5-4 Mc/s LINE RESIDUAL EQUALISER, WITH ALL SECTIONS SET AT 2-DB. PAD LOSS.

The delay simulator comprises delay sections which closely match the delay distortion of 0, 1, 2, 4, 8, and 8 repeater sections.

As correction for cable temperature on the main line is effected at selected stations in discrete steps, it is necessary to pre-distort the injected signal by a corresponding amount. To do this, positive and negative fractional temperature-equaliser sections can be switched in as required. The sections provided are 0, $\pm \frac{1}{2}$, $\pm \frac{1}{4}$ and ± 1 units of temperature equalisation and, as on the main line equipment, each unit corresponds to 0.3 miles of 375E-type coaxial cable. The sections can be individually switched into circuit as required.

The closeness of adjustment possible is indicated by tests made at the first repeater station out from London on the Wenvoe-London link with 23 repeater sections to be simulated, when an overall response of ± 0.7 db. and ± 0.15 microsecond was obtained, compared with ± 0.65 db. and ± 0.08 microsecond on the full main line.

The injection amplifier is a 27 db. flat-gain amplifier which is also used in the line terminal equipment; it is required to raise the level of the modulated signal to the correct value for the line as well as to compensate for the loss in the equalisers and simulators.

As the C.E.L. No. 4 line system has two line pilots (308 and 4,340 kc/s) which are independent of the television translating equipment, proper operation of succeeding intermediate amplifiers and the control terminal requires that these pilots be transmitted irrespective of an injection being made. This is achieved by the pilot-pass filters and the combining hybrid shown in Fig. 12.

*Pad Loss is the loss of the pad which forms the basis of each section of the line residual equaliser.

Operation.

Operation of the 0.5-4 Mc/s injection equipment follows a procedure similar to that outlined for the 3-7 Mc/s equipment. However, due to the greater complication of this system, somewhat longer time is required for setting up and testing. A fairly lengthy period is required for the modulator, particularly, to reach stable working conditions. Many satisfactory broadcasts have now been made with the aid of this equipment and the use as portable equipment of a

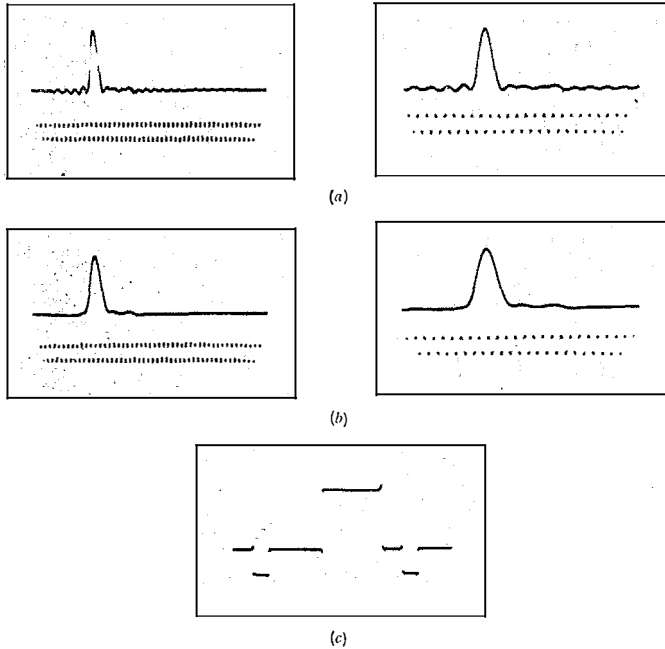

FIG. 14.—WAVEFORM RESPONSES OF 0.5-4 Mc/s O.B. INJECTION CIRCUIT ON THE WENVOE-LONDON COAXIAL-CABLE LINK (INJECTION AT SLOUGH).

Book Review

"Television." V. K. Zworykin and G. A. Morton. Wiley. 1037 pp. 698 ill. 140s.

This is the second edition of a book that first appeared some 14 years ago; but it is a completely revised and greatly expanded edition, for developments in the television field during the intervening period have been very rapid. The book, which is profusely illustrated, is divided into four parts, dealing with: 1. Fundamental Physical Principles (168 pp.); 2. Principles of Television (133 pp.); 3. Component Elements of an Electronic Television System (449 pp.); and 4. Color Television, Industrial Television and Television Systems (264 pp.).

The approach to the subject is physical, as the title of the first part implies, and starts with a discussion on the structure of metals, semi-conductors and insulators; the emission of electrons by thermal and photo effects; and the theory of luminescence. The principles of electron optics are dealt with and practical electron optical systems and their aberrations are described. These are the fundamentals upon which television, as we know it to-day, depends.

The second section describes the general principle of television transmission—how the picture is scanned, or analysed, at the camera end and converted into an electrical signal; and how it is put together again and produced as a visible image at the receiver. The theory of single sideband transmission is dealt with in some detail.

The third and largest section deals with the component parts of an electronic television system ranging from camera

tubes and cameras to transmitters and aerials, and receivers and cathode-ray tubes. Dr. Zworykin, one of the co-authors, was largely responsible for the invention of the iconoscope camera tube and this device is fully described in a chapter of its own.

CONCLUSION

The injection facility is well used, as was indicated in Table I of Part I, and is a valuable means of extending the range of B.B.C. outside broadcasts. It is likely that similar facilities will be required on future main cable links, but unfortunately, although those currently planned will employ 0.5-4 Mc/s vestigial sideband transmission, neither the form of the modulated signal nor the detailed design and operating conditions of the line system have yet reached finality. A universal form of 0.5-4 Mc/s injection equipment is not, therefore, practicable.

ACKNOWLEDGMENTS

The 3-7 Mc/s injection equipment was designed and made by the Radio Experimental and Development Branch, E.-in-C.'s Office, the portable versions of the modulator and demodulator and the stackable racks for the 0.5-4 Mc/s equipment were designed and made by Standard Telephones and Cables, Ltd., and the line simulator unit and the injection amplifier assembly were designed and made in the Research and the Transmission and Main Lines Branches of the Engineer-in-Chief's Office.

References.

- ¹Kilvington, T., Laver, F. J. M., and Stanesby, H. The London-Birmingham Television-Cable System. *Proceedings I.E.E.*, Vol. 99, Part 1, p. 44, 1952.
- ²Halsey, R. J., and Williams, H. The Birmingham-Manchester Television-Cable System. *Proceedings I.E.E.*, Vol. 99, Part IIIA, p. 398, 1952.
- ³Roche, A. H., and Weaver, L. E. Television Frequency-Translating Equipment for the Birmingham-Holme Moss Coaxial Cable. *Proceedings I.E.E.*, Vol. 99, Part IIIA, p. 455, 1952.
- ⁴Halsey, R. J., and Williams, H. The Birmingham-Manchester-Holme Moss Television-Cable System. *P.O.E.E.J.*, Vol. 46, pp. 118 and 171, Oct. 1953 and Jan. 1954.
- ⁵A Vehicle for Television Outside Broadcast Service. *P.O.E.E.J.* Vol. 46, p. 93, Jul. 1953.

tubes and cameras to transmitters and aerials, and receivers and cathode-ray tubes. Dr. Zworykin, one of the co-authors, was largely responsible for the invention of the iconoscope camera tube and this device is fully described in a chapter of its own.

The fourth section deals mainly with colour television, a subject of great interest at the present time, but also goes on to describe various non-entertainment uses for television. Television is coming into increasing use in industry, where it enables an operator to watch a dangerous process from a safe distance or may enable one operator to keep an eye on conditions at a number of widely separated points. Television has also been used extensively in teaching. It enables surgical operations or microscopic demonstrations to be displayed simultaneously to large groups of students instead of a small number of individuals. It is even suggested in this volume that with the very simple camera chains that are now available, television may find an application in the home for keeping an eye on the baby or the kitchen stove from the comfort of an armchair!

Although the price of the book will preclude its becoming popular with amateur television enthusiasts, it is undoubtedly a major contribution to the field of television literature, coming as it does from the pens of two such eminent workers in the field. It will find its place in the libraries of all technical establishments concerned with the subject and will be in great demand from those lending libraries that include it in their lists.

T. K.

Completion of the First Transatlantic Telephone Cable

U.D.C. 621.315.285

In the October, 1955, issue of the Journal, the laying of the first transatlantic telephone cable was described as far as the buoying-off at Rockall and commencement of the loading, on H.M.T.S. *Monarch*, of the 500 n.m. of cable required to reach Oban. This note covers the final laying operation in the 1955 programme.

LOADING was completed on 9th September and *Monarch* sailed from Erith on 12th September, 12 days ahead of schedule. The weather was poor from the start and by the time *Monarch* reached Belfast Lough in the evening of 14th September she had already experienced heavy gales. Proceeding through the North Channel she entered the open Atlantic and, in very indifferent weather, a course was set for the point at which the cable route crossed the edge of the Continental Shelf; here a marker buoy was put down in a rough sea. Proceeding along the cable route, taut wire was run out for 100 n.m. and a second marker buoy was put down.

The approximate site of the end of the cable was reached on 17th September and it was soon confirmed that the cable buoy which had been placed on 18th August had broken loose; it was subsequently reported off the Faroes, 500 miles distant. After placing a marker buoy, grappling runs were made, at right angles to the cable, moving progressively westward; five such runs, all unsuccessful, were made during the period 17th-20th September.

In the evening of 20th September, weather conditions deteriorated badly; by next day the barometer had fallen steeply to 28.8 in. as the depression approached. The wind force exceeded the maximum measureable on the ship's anemometer; this maximum, 70 knots, corresponds to Force 12, the highest recognised force on the Beaufort Scale and, technically, a hurricane. The fact that our American colleagues on board assured us that "real" hurricanes could be much worse gave little consolation! The photograph gives a very inadequate impression of the sea; the swell approached 40 ft. in height.



HIGH SEAS BREAKING OVER *Monarch's* BOWS.

Book Review

"Circuits and Networks." G. Koehler. The Macmillan Company, New York. 349 pp. 169 ill. 45s. 6d.

Written as a text for the undergraduate student in electrical engineering, this book is a simplified version of more standard works on the subject which bear similar titles. It deals with most of those topics which one expects to find in a classical book on network theory written 20 years ago and, in some respects at least, its general outlook on the subject is of that

To proceed with operations was impossible, and it was fortunate that the cable had not been picked up, otherwise it would have been necessary to cut it. The ship's course was set into the wind and by the next morning, when the worst of the storm was over, she was some 25 n.m. southwest of the cable end. Returning to the site it was found that the marker buoy had disappeared. When the sea had subsided somewhat, a new buoy was placed and a sixth grappling run was made, this time successful, and the cable came on board at 02.50 hours G.M.T. on 22nd September. It had been hooked 5.3 n.m. from the end, and it had clearly been crossed and missed on the fifth run. This had been fortunate indeed!

Measurements between Clarenville and the ship established that all was well with the cable. The last remaining equaliser (of the required type) was spliced in and paying out began at 19.50 hours G.M.T. on 22nd September. In order that the ship should enter the Firth of Lorne in daylight, the laying speed was maintained somewhat lower than previously. The weather was tolerable though far from kind; the second marker buoy laid on the outward run had disappeared but the first remained. The ship reached the shore-end cable buoy off Oban at 08.05 hours G.M.T. on 26th September and dropped anchor; the shore end, 2 n.m. in length, had previously been laid by *Iris*, assisted by a Clyde "puffer".*

The total laid length between Clarenville and Oban is 1,941 n.m. and the 51 repeaters give a total gain of 3,300 db. at 164 kc/s; six equalisers are included at junctions between the 11 ocean blocks.

Sir Gordon Radley was present for the final splice and when the core joint had been completed about a dozen Press representatives came aboard, witnessed the final operations and saw the splice go overboard at 17.30 hours G.M.T. By this time, technical interest was focused on Oban B Repeater Station where preparations were in hand for shore-to-shore testing of the cable. The assembled group of engineers, British and American, saw power applied to the completed cable for the first time; the voltage of the constant-current power units, feeding 225 mA to line, rose to about 2,000V at each end. Initial transmission tests, completed the same evening, showed that all was well; the west-to-east cable had been satisfactorily completed six days ahead of schedule and telephone history had been made.

At the time of writing, the cable has been under close observation for nearly two months and has shown only a small decrease in attenuation, appropriate to seasonal temperature changes.

R. J. H.

*The laying of the shore ends is described in "The Transatlantic Cable Landed" under Regional Notes, Scotland, p. 253 in this Journal.

period. The chapter headings, briefly, are: 1, Methods for solving circuits; 2, Network theorems; 3, Simple frequency-selective circuits; 4, Coupled circuits; 5, Four-terminal networks; 6, Filters; 7, Attenuators and equalisers; 8, 9, 10, Transmission lines; 11, Transformers and reactors.

The reader is assumed to have a working knowledge of simple alternating-current theory and, from this starting point, is led in easy stages to the basic principles concerned in each section. The treatment is elementary and at no time does the author

(Continued on p. 245)

A Method of Recording Contact Resistance Under Dynamic Conditions

T. F. A. URBEN, B.Sc.(Eng.), A.M.I.E.E.,
and S. H. SHEPPARD†

U.D.C. 621.317.331 : 621.3.066.6

Equipment developed for automatically testing and recording the resistance of contact elements is described and some of the results of the tests made with it are discussed.

INTRODUCTION

A FUNDAMENTAL requirement of telephone switching systems is reliable low-resistance connection between metallic surfaces brought together under pressure, either intermittently as for relay contacts and selector wipers, or in relatively permanent contact as for plug and jack connections. Equipment designers are therefore constantly searching for ways of improving the performance of such contacts if this can be achieved without undue expense.

The main factors on which the performance of a contact depends are its resistance to wear, especially if it is a sliding contact, and the electrical resistance of the contact between the moving and the fixed element. In comparing the performance of different materials, the resistance to wear may readily be determined by "life tests" in which specimens made up from different materials are operated on a strictly comparative basis for a long period and the rates of wear compared. It is not so easy to compare contact resistance, particularly with base metals, as their resistance to wear, which is superior to that of most noble metals, is due to a surface film on the material which is very hard and may be insulating in character. This film may give erratic results if the electrical resistance of contacts making with light pressure is measured on individual specimens, but the performance may be determined statistically if a large enough number of measurements and specimens are taken. Breakdown of the surface film to give good contact may be brought about by application of adequate pressure, either mechanical or electrical. Once this film has been broken down the fundamental resistance of the "made" contact depends upon the hardness of the material and the consequent area over which metallic contact is obtained. In this respect silver and gold are far superior to nickel-silver and phosphor-bronze, as they are soft and provide a comparatively large area of metallic contact.

It was learned in 1952 that the Netherlands P. & T.T. Administration had been testing rhodium-plated wipers, and these tests seemed to indicate that the electrical resistance of the contact was reduced while, at the same time, the wear-resisting properties of the wiper were increased. Rhodium had also been receiving attention in this country, notably in the radio field, as it was claimed to be an excellent contact material for use where very low electrical potentials were involved. The Netherlands tests showed that, compared with the type of wiper and bank contact previously in use in Holland, the rhodium-plated wiper operating on brass bank contacts proved to have great advantages, so much so that the cost of rhodium plating wiper blades appeared to be economically worth while. Such a prospect was most attractive as it is considerably easier to plate wiper blades than bank contacts.

The type of wiper and bank combination used as standard by the British Post Office is not quite the same as that used in the Netherlands; the 2000-type selector uses a wiper with a rounded tip, whereas the wiper used in the Netherlands has a flat blade. Moreover, the Siemens-Halske switch used in the Netherlands is solidly mounted and, therefore,

very sensitive to noise produced by vibration from adjacent switches and the rhodium-plated wiper was claimed to reduce this noise very extensively, but the 2000-type selector is mounted on resilient rubber shock-absorbers effectively insulating it from microphonic pick-up. For these reasons it was arranged that analogous tests on wear and contact resistance should be carried out by the British Post Office to determine the performance of the rhodium-plated wiper under the conditions obtaining in this country.

Several sets of wipers were obtained, some being plain nickel-silver Wipers, No. 12, and the remainder having rhodium-plated tips with differing degrees of polishing. The sample wipers were fitted to special selector mechanisms, modified to operate under rotary action only, and were arranged so that several wipers entered their respective levels simultaneously and were rotated to marked outlets. By this means the possibility of damage to the wipers due to incorrect cutting-in and vibration after vertical action was eliminated, and the comparison of wear confined simply to that due to the wipers rotating over the bank contacts.

With the quantity of wipers on test, it would have been impracticable to make sufficient measurements of the contact resistance of each by any manually controlled test, and an automatic tester was designed which was arranged to measure the resistance between one of several wiper-to-bank contact pairs each time the selector wipers were stopped on a contact. By this means it was possible to make some 1,300 individual contact-resistance tests per day on each of eight different contact pairs.

Subsequently the automatic tester has been used in experimental work on selector plug and jack contacts.

THE AUTOMATIC TESTER

To provide an effective comparison between contact pairs of different materials it was decided to omit the signalling and microphone direct current normally carried by switching contacts (which tends to mask differences between "good" and "bad" contacts), and to arrange that the tester should measure the potential drop produced across the contacts by an alternating current of 1 mA, frequency 1 kc/s, flowing in the circuit. This current was to be fed from a source of 1V potential. The result of the test was to be recorded by the operation of one of a group of five digit-meters covering the required resistance range in the following steps:—

- (i) less than 0.01 ohm ($10 \mu\text{V}$ P.D.)
- (ii) 0.01 to 0.1 ohm
- (iii) 0.1 to 1 ohm
- (iv) 1 to 10 ohms
- (v) over 10 ohms.

The resistance value was to be recorded during a period of 100 mS duration, commencing 5 mS after the wiper under test had stopped on the particular contact. To cater for testing a number of different sample wipers, several groups of recording meters were necessary.

An amplifier was developed comprising a pre-amplifier having a voltage gain of 10^2 followed by three stages, each with a gain of 10, connected in cascade. Trigger circuits, operating at 1V, and controlling relays, were tapped off the amplifier chain after the pre-amplifier section and after each succeeding stage, as shown in Fig. 1.

† The authors are, respectively, Senior Executive Engineer and Assistant Engineer, Telephone Development and Maintenance Branch, E.-in-C.'s Office.

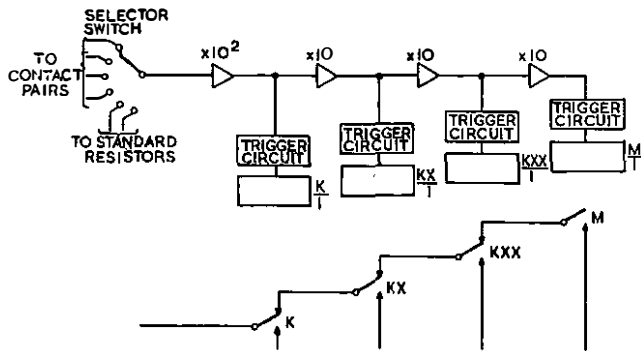

FIG. 1.—BLOCK SCHEMATIC DIAGRAM SHOWING THE PRINCIPLE OF THE AUTOMATIC TESTER.

Connections to Wiper Contact under Test.

The mechanical arrangements adopted for life-testing the wipers (360° rotation of wiper carriage) did not allow a direct connection to the wiper for resistance measurement, and the circuit arrangement adopted was as shown in Fig. 2. A

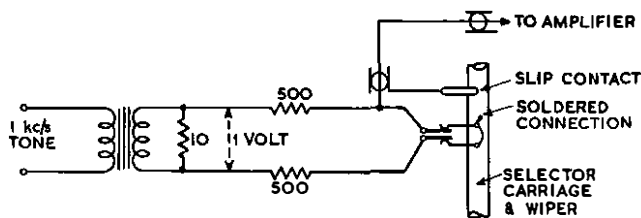

FIG. 2.—METHOD OF APPLYING TEST TONE TO A WIPER AND BANK-CONTACT ELEMENT.

step-down transformer connected to the output of the oscillator, and terminated with a load resistor of 10 ohms, provided a low value of source-impedance for the test tone and thus ensured that its potential remained constant, irrespective of the fluctuations of wiper resistance. As the calibration of the amplifier-detector circuits assumed a current of 1 mA in the contact, a progressive error was introduced with increase of wiper resistance. Over the range of wiper-resistance values of particular interest, namely up to 100 ohms, the error was insignificant relative to the broad classification of the recorded results.

Circuit requirements made it necessary to apply the test tone to the sample wiper for the period of the resistance test only. The tone switching had been arranged by short-circuiting the primary of the tone-feed transformer, but it was found that the resistance of the contact and associated wiring allowed a low-level "leak" tone which falsely operated relays in the amplifier. To overcome this fault it was necessary to mount the tone-control relay within the oscillator and to use its contacts to "earth" the grid of the output valve.

A proprietary rotary selector-switch was found to be most suitable for switching the amplifier to the selected wiper under test and auxiliary "wafers" were used to select the appropriate group of recording meters.

The Amplifier.

Choice of a suitable type of valve for use in the amplifier was governed by the following considerations:—

- (1) To be of low-noise, low-microphony design and preferably a single-ended type.
- (2) Amplification factor sufficiently high to give a stage gain of 10, with adequate negative feedback applied, permitting a single valve to be used for each of the later stages of the amplifier.

A pentode valve (CV2135) was selected to meet these requirements, and preliminary tests showed that the

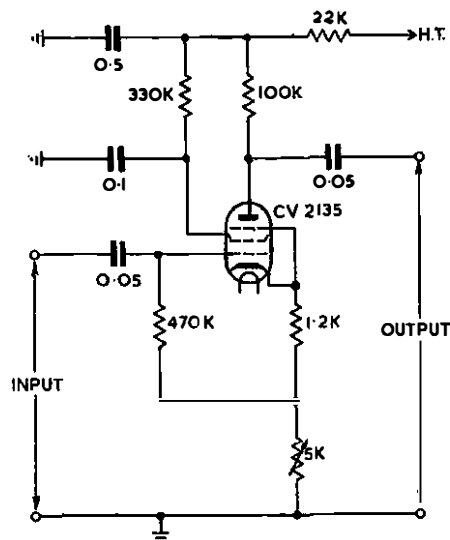

FIG. 3.—CIRCUIT OF AMPLIFIER STAGE.

required voltage gain could be obtained with a circuit arranged as shown in Fig. 3.

Having regard to the high overall gain required for the amplifier, it was expected that special precautions would be necessary to isolate the input stages from vibration and to eliminate hum, etc. For this reason it was decided to build the amplifier in two units; a pre-amplifier with a voltage gain of 100 mounted on a sub-chassis, and the remaining amplifier stages, voltage-discriminating detectors and associated relays mounted on the main chassis. The pre-amplifier sub-chassis was mounted on top of the main chassis. Initially, the pre-amplifier was built with overall feedback, but the stability was improved by substituting individual feedback on each stage and this arrangement was adopted. The complete amplifier then comprised five stages, each arranged generally as in Fig. 3, and four voltage-discriminating detector elements connected to appropriate points along the amplifier chain. To obtain the critical operating-voltage feature for the detector element, it was necessary to produce a rapid rise of current in the relay coil for a predetermined input-tone voltage, and the "trigger" circuit shown in Fig. 4 was employed.

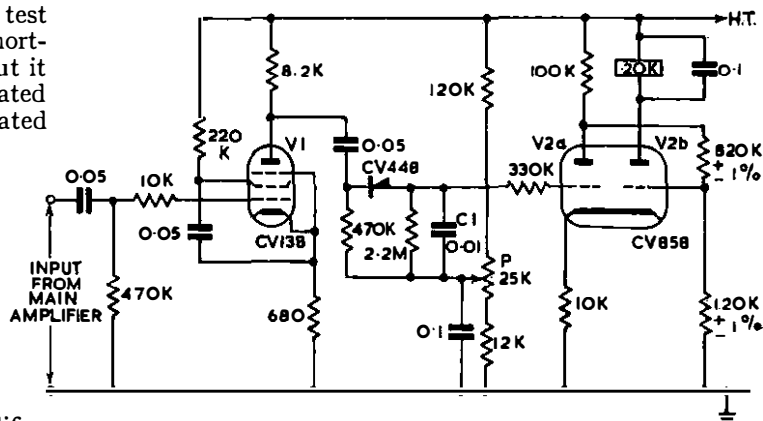

FIG. 4.—BUFFER AMPLIFIER AND "TRIGGER" CIRCUIT, WITH DETECTING RELAY.

The two sections of valve V2 are connected as a cathode-coupled mono-stable trigger pair. Under quiescent conditions section V2a conducts because its control grid is held sufficiently positive by potentiometer P to overcome the self-bias voltage developed across the common-cathode resistor (10K ohms). The circuit is arranged so that, with V2a conducting, the voltage at the control grid of V2b is

sufficiently negative, with respect to the cathode, to ensure that this section of the valve is biased to "cut off." On application of an input-tone voltage to the circuit, the signal is rectified and appears as a negative voltage across capacitor C1 tending to oppose the positive-bias voltage applied to the grid of V2a. When the negative voltage due to the signal is of sufficient magnitude, depending upon the adjustment of potentiometer P, the anode current of V2a falls and the cathode-bias voltage is correspondingly reduced. Section V2b then begins to conduct and increases the cathode-bias voltage, thereby further reducing the anode current of section V2a. The cumulative effects produce a very rapid transfer of the anode current from section V2a to section V2b and the anode relay operates. Removal of the negative voltage due to the input tone allows section V2a to regain control and an equally rapid change-back occurs, causing the relay to release. The critical operating voltage characteristic of the circuit is such that, with an input-tone voltage of 0.99V, no current flows in the relay coil, but increasing the input tone to 1V causes the circuit to trigger and produces an anode current in V2b of 4.5 mA, which operates the relay.

The amplifier obtained its H.T. supply from a normal stabilised mains unit and the heaters were fed from an A.C. supply, but the amplifier chassis and wiring-returns were isolated from the common earth-feed. Fig. 5 illustrates the general appearance of the complete amplifier.

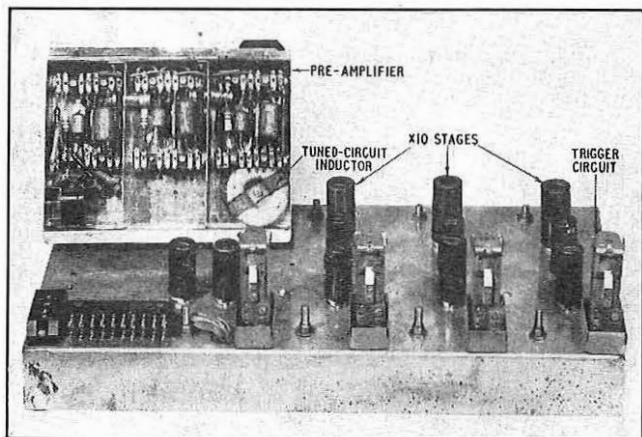

FIG. 5.—THE COMPLETE AMPLIFIER.

The amplifier was connected to the contact under test through a mu-metal shielded input transformer having a ratio of 1 : 50. Initially, a resistor-capacitor input-circuit had been used, but the stray pick-up was excessive and it was necessary to reduce the input impedance, by means of the transformer, to a value commensurate with the maximum resistance value to be measured. The random noise at the output stage of the amplifier, produced by valve hiss, etc. in the early stages, was effectively reduced by substituting parallel resonant L-C circuits, tuned to 1 kc/s, for the grid resistors of the second and third stages of the amplifier.

Control of Test Sequence.

Concurrently with the development of the amplifier, a circuit was designed for incorporating the resistance test into the life-test cycle of sample wipers, provision being made to apply the resistance test in turn to eight of the sample wipers undergoing life test, and to interrupt the life-test cycle as the wiper to be tested reached its marked outlet. By suitable strapping, any of the sample wipers could be chosen for resistance test. Prior to each cycle of resistance tests on the eight sample wipers, the calibration of the amplifier and voltage-discriminating detectors was checked by switching the amplifier input, in turn, to

"standard resistors" of suitable values connected to the tone supply. Other facilities given by the circuit included checking that the relays associated with the voltage-detector circuits were all normal, i.e. not falsely operated to surges or "noise" before applying the test tone to the wiper under test, and control of the timing and duration of the resistance test. For this control feature a variable delay was introduced between the selector reaching the marked outlet and the commencement of the resistance test, and also the duration of the test period could be controlled within certain limits.

Sampling Pulse Circuit.

From observation and analysis of the results of the early tests on wipers it was noticed that, in some instances, the wiper resistance was not constant during the test period and the changes could cause more than one recording meter to operate. The effect was considered to be due to contact "bounce" or oscillation of the wiper tips, and the fluctuation of effective resistance was evident from oscillograms of the tone-voltage output from the amplifier recorded during selected test periods.

The incidence of dual registration, due to resistance variation, depended upon operate lags of meters, duration

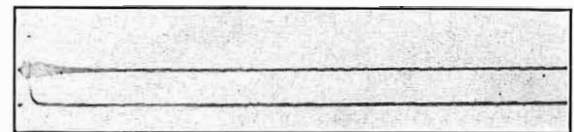

(a) Wiper with Unpolished Rhodium-Plated Tip.

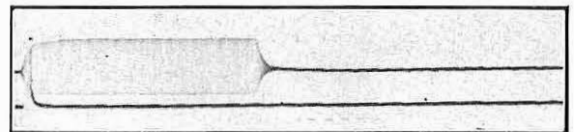

(b) Nickel-Silver Wiper.

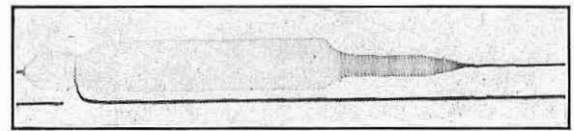

(c) Nickel-Silver Wiper.

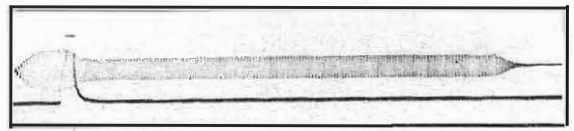

(d) Wiper with Unpolished Rhodium-Plated Tip.

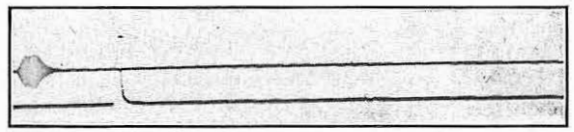

(e) Wiper with Unpolished Rhodium-Plated Tip.

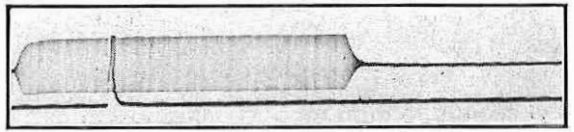

(f) Wiper with Unpolished Rhodium-Plated Tip.

The lower trace on each oscillogram is that of the sampling pulse, which is delayed relative to the start of the test period by the following amounts:—

- (a) and (b): 5 mS.
- (c) and (d): 20 mS.
- (e) and (f): 80 mS.

FIG. 6.—OSCILLOGRAMS SHOWING THE TONE-POTENTIAL ACROSS CONTACTS UNDER TEST.

and magnitude of resistance change, etc., and thus, in effect, tended to produce false comparisons between sample wipers. It was decided that more accurate results would be obtained by "sampling" the conditions of the voltage-discriminating relays at a predetermined point within the test period. The control circuit was modified to incorporate a timing unit, producing a short-duration pulse (5 mS) at a predetermined interval, adjustable between 5 and 120 mS after commencement of each test period. High-speed relays were associated with the contacts of the discriminating relays to register the pulse and, by their locking contacts, to ensure operation of the appropriate meter.

In Fig. 6 are reproduced oscillograms showing the tone-potential across the contact under test and illustrating, for various settings of the delay control, the occurrence of the "sampling" pulse relative to the test period. These records are also of interest to illustrate the differences of contact resistance between sample wipers and the fluctuations which may occur due to movements of the wiper blades after rotating to an outlet. Oscillograms (a) and (e) represent successive operations of the same sample wiper (rhodium-plated tip, unpolished) and it can be seen that contact resistance of a very low order is obtained after the initial "settling" of the wiper on to the bank contact. A less favourable performance is given by a similar sample wiper as recorded by oscillograms (d) and (f). The change of contact resistance towards the end of the test period, recorded on oscillogram (c) (nickel-silver wiper), is probably due to slight movement of the wiper caused by vibration from adjacent apparatus. Oscillogram (b) was recorded from a standard nickel-silver wiper and shows a consistently high resistance.

RESULTS OF TESTS ON WIPERS

The first series of tests on wipers indicated that, at the low potential and current values used in this test, the range of resistance was higher than originally expected. Very few operations were recorded on the lowest voltage-detector (M in Fig. 1) and the highest percentage of recordings were for resistance values greater than 10 ohms (relay K). On the basis of these results it was decided, for the remainder of the wiper tests, to reduce the amplifier gain, so increasing by a factor of 10 the resistance ranges recorded on each meter. The change had the desired effect on the distribution of recordings over the group of meters, as the greater percentage of registrations were obtained on the two middle groups representing resistance values of 10-100 ohms (KX) and 1-10 ohms (KXX).

TABLE 1
Total Number of Tests, 12,160. Pulse at 50 mS.
Number of Tests per Contact, 1,520.

Wiper Tip Material	Contact No.	Per Cent. (over 100Ω)	Per Cent. (10-100Ω)	Per Cent. (1-10Ω)	Per Cent. (0.1-1Ω)
NS	1	69	7.9	9.14	12.25
NS	2	64.3	17.7	10.9	1.18
RP NP	3	27.4	11.45	25	30.65
RP NP	4	—	—	—	99
RP PBP	5	22.1	20.25	32.2	20.9
RP PBP	6	58	12.2	14.1	11.25
NS	7	100	—	—	—
NS	8	96.4	2.1	—	—

NS: Nickel silver. RP NP: Rhodium-plated tip, unpolished. RP PBP: Rhodium-plated tip, polished before plating.

A typical set of results for the tests carried out in one period of 24 hours is shown in Table 1. It indicates that on that day three out of four of the rhodium-plated wipers were generally of lower resistance than the nickel-silver wipers; the reduction in resistance was not, however, com-

pletely consistent, and from the evidence of the overall tests it was considered that the improvement of contact resistance was not sufficient to justify plating the wipers without similar treatment to the bank contacts. A further factor militating against the use of rhodium-plating on wipers only was that, at the end of the test, it was found that those bank contacts on which the plated wipers had been running were deeply grooved.

The cost of plating bank contacts, in which each contact may have to be treated individually, is prohibitive for use on standard bank contacts; it would be impossible, in any case, to apply plating on contacts *in situ*. On the other hand, with present circuits, a direct current is always present for signalling purposes, so ensuring a satisfactory contact with nickel-silver elements, and little advantage would be obtained from a plated contact.

For these reasons it has been decided that there is, as yet, no justification for changing to noble metal surfaces on switch wiper and bank contacts.

TEST OF SELECTOR PLUG AND JACK CONTACTS

Subsequent to the work on wiper contacts, an investigation was commenced into possible alternatives to nickel-silver for plug and jack contacts, for use in circuits where normal potential D.C. (i.e. 50V) is not available for contact "wetting" purposes. While silver-plated contacts on shelf plugs and jacks have proved suitable with regard to effectiveness of contact, the silver is prone to "migrate" over the surface of the separating insulation, and the resultant low insulation and short-circuit faults have given considerable trouble in the field. Various alternative materials had been suggested and, as part of the development programme, it was decided to determine which were the most suitable under different contact pressures simulating, under control, the conditions likely to be met with varying plug and jack pressures.

It was decided to use the automatic resistance-tester on samples of which the making pressure could be varied automatically. For this purpose a variable-pressure test-jig was developed and is shown in Fig. 7. This consists of four

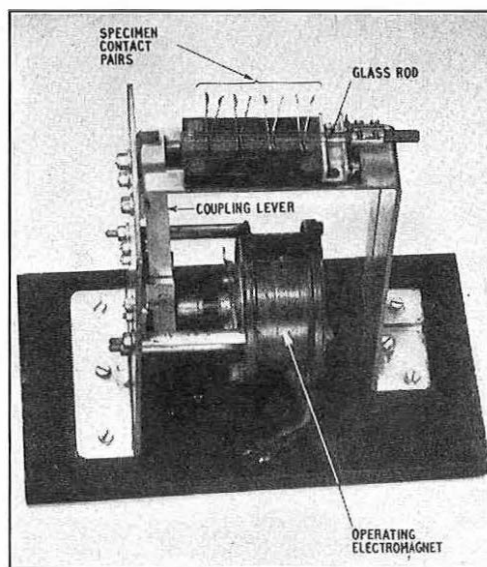

FIG. 7.—VARIABLE-PRESSURE TEST-JIG.

pairs of specimen contacts held under pressure by the armature-restoring springs of an electromagnet. Energising the coil relieves the tension of the springs and reduces the applied contact pressure. The individual blades of a specimen contact pair are curved, with their respective

arcs of curvature disposed at right-angles to each other, so that contact between the springs is limited to a small area. The spacing blocks between the contacts rest on polished steel balls let into their bases, and the sliding friction is further minimised by undercutting and chamfering the inner faces of the parallel guides. The operating coil of the electromagnet is fitted over a central circular core, diameter approximately 11/16 in., and is enclosed by the outer case, which forms the return path for the magnetic flux. An annular gap, of 3/32 in. width, exists between the front end of the core and the case. The circular armature is of larger diameter than the annular gap, and is located above it by flat restoring-springs disposed at 120° intervals around the armature periphery. Brass washers, having a clearance hole for the armature, control the distance between the face of the armature and the annular magnetic gap, and a copper-foil washer immediately over the pole-face serves as a residual plate. The glass rod above the contact specimens was a modification found necessary from operating experience; under repeated cycles of contact-pressure variations the contact specimens tended to "ride out" of the jig, and the glass rod was positioned to restrict their movement.

For initial calibration of the pressure-jig, the armature of the electromagnet was adjusted to obtain a contact pressure of 250 gms. with no current in the energising coil, and current values were then determined for a range of contact pressures. It had originally been intended to energise the electromagnet of the pressure-jig from the normal 50-V supply, with switched resistors to control the pressure obtained, but the changes of pressure due to battery-voltage fluctuations proved to be excessive; this effect was most severe for the lower values of contact pressure and, at 20 gms., a voltage change of -4V produced a pressure variation of +100 per cent. The difficulty was overcome by using a cathode-follower stabiliser-circuit, with the pressure-jig electromagnet as the cathode load for two parallel-connected valves, type CV345, V1 and V2 in Fig. 8, and operating the circuit from a mains power-pack (150V supply). Adjustment of cathode current, to obtain

the required pressure values, was arranged by switching the control grids of the valves to preset potentiometers, connected in parallel across a voltage-reference tube, type CV438.

The control circuit developed for the automatic registration of contact-resistance values for changes of contact pressure was designed with future requirements in mind and was made as flexible as possible. Unattended operation of the tester for prolonged periods was required, and the circuit incorporates self-checking facilities combined with extended alarm conditions, to draw attention to faulty operation. The variable-pressure jig had been designed to accommodate four specimen contact pairs but the combination of the two variables, pressure and resistance value, would have necessitated provision of 25 recording meters per contact pair, and it was decided to restrict testing to two specimen pairs. A rotary selector switch (SW in Fig. 8) is used to switch the high-gain amplifier to test resistors (R1-R4 in Fig. 8) and to the specimen contact pairs but, to avoid unnecessary wear on the selector switch, a special relay is used to select the test samples alternately. This relay (LCR) is an adaptation of the 3000-type design, fitted with a single changeover contact constructed from stiff, gold-plated wires giving low self-capacitance and low contact resistance.

By operation of a key it can be arranged that recording of contact resistance is made either,
 (a) as the pressure is reduced in steps, or
 (b) as the pressure is increased in steps to a maximum and then reduced in steps, or
 (c) as the pressure is increased in steps.

To cater for possible fluctuations of contact resistance during the measuring period, the test duration may be set to alternative values under the control of a Meter Pulse key.

Results of Contact-Pressure Tests. A typical set of measurements is shown in Table 2 and illustrates the rise in the percentage of low-resistance contact readings obtained as the contact pressure was increased. In particular it shows that the contact resistance of the nickel-silver pairs was mainly between 1 and 10 ohms, whereas that of the phosphor-bronze/silver bi-metal contacts fell to a value between 0.01 and 0.1 of an ohm with contact pressures of 80 gms. and above. As the tests in this investigation were carried out with a supply-tone potential of 0.1V, in order to be more sensitive to the differences in contact resistance at the higher pressure involved in this test, the marked superiority, at low-signal potentials, of silver bi-metal at the normal pressure met in shelf plugs and jacks (approximately 100 gms.) is noteworthy.

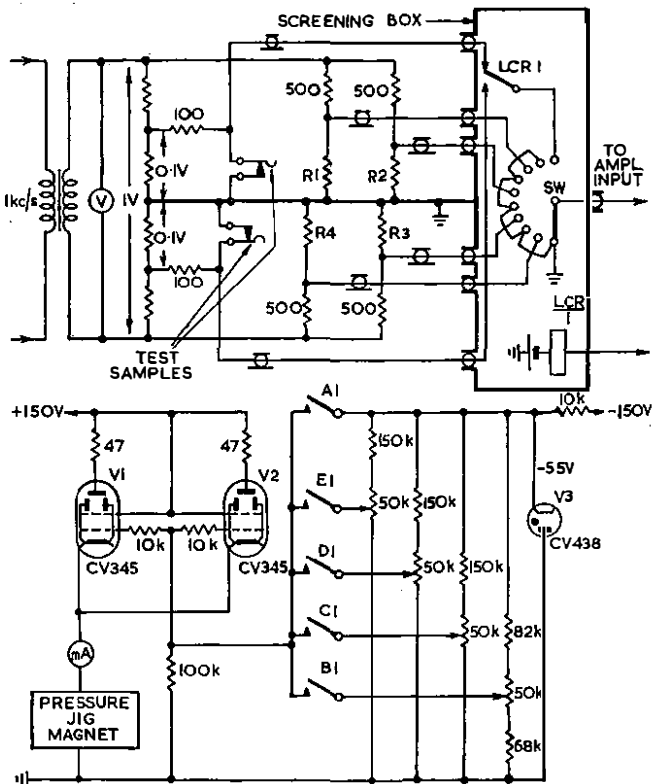

FIG. 8.—CIRCUIT OF VARIABLE-PRESSURE TEST-JIG.

TABLE 2

Pressure Increasing in Steps.
 Total Tests, 18,380. Average Tests per Pressure, 1,838.

Contact Material	Pressure gms.	Over 10Ω	1-10Ω	0.1-1Ω	0.01-0.1Ω	Below 0.01Ω
Nickel-silver	20	249	1,569	—	—	—
	40	180	1,640	19	—	—
	80	36	1,774	22	—	—
	160	2	1,802	32	—	—
	200	—	1,792	44	—	—
Phosphor-bronze/Silver bi-metal	20	63	377	394	398	613
	40	40	475	589	310	430
	80	—	6	511	798	528
	160	—	—	261	1,047	537
	200	—	—	155	1,102	583

During the period of operation of the tester, a number of alternative contact specimens were tried, and Fig. 9, showing the condition of one at the end of the tests,

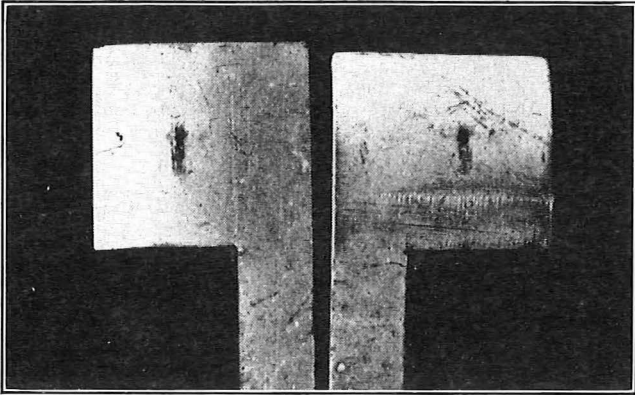

FIG. 9.—SPECIMEN CONTACT PAIR AT THE END OF THE TESTS.

illustrates the surface abrasion resulting from the repeated pressure changes in the test-jig. From the contact-resistance recordings obtained it was evident that the condition of the contact surface had an important effect and specimens with surface irregularities, such as scratches, tended to develop high contact resistance. The fabrication and

preparation of the specimens had resulted in lack of uniformity of surface condition, and the effect mentioned may have invalidated certain of the comparisons between alternative contact metals.

CONCLUSION

The development of the automatic resistance-tester has provided a valuable tool for the rapid testing of contact resistance and comparison of contacts on a statistical basis. It has already been put to further use in preliminary testing of the efficacy of solderless wrapped joints, and will shortly be engaged on a further programme of tests on plug and jack contacts when the sliding action of the contacts on each other during insertion and withdrawal will be simulated automatically under strict control.

ACKNOWLEDGMENTS

The authors are indebted to colleagues in the Telephone Development and Maintenance Branch of the E.-in-C.'s Office for their assistance in the work described and to Messrs. D. O. Walter of Johnson Matthey, Ltd., and H. D. Ward of Ericssons Telephones, Ltd., for supplying samples used in the tests.

Book Review

“Circuits and Networks”—*continued from p. 239.*

attempt to discuss detailed technical applications. These are the good points of the book.

In criticism it must be said that the approach to many of the sections is old-fashioned and that the general arrangement is unbalanced. This is not to suggest that the student should be presented with a digest of all recent contributions to circuit theory, but rather that the basic training should reflect these contributions by describing the foundations of the subject from the more unified standpoint that they permit.

As an example, the concept of duality may be quoted. In geometry this fundamental idea is emphasised even in the most elementary undergraduate text. The same concept applies, with equal force, to circuit theory and one would expect any recent book to exploit its features to advantage. Having described the properties of a series-tuned circuit, those of a parallel circuit follow immediately from considerations of duality; Norton's theorem (so called) is the dual of Thevenin's theorem; nodal analysis of circuits is the dual of mesh analysis. These examples, and many others, all appear in Prof. Koehler's book described separately and without mention of this simple connecting link. Three pages devoted to the ideas of duality might have saved many pages of duplicated explanations and given the student a clearer picture.

The chapter describing filters is particularly misleading. About twenty-five years ago, Cauer and Bode, starting from the practical circuits given by Campbell and Zobel, gave a complete theory of the image parameters of a reactance network and showed that the filter-like properties of these parameters were not dependent upon the network having any specific internal configuration. In common with certain other writers, Prof. Koehler has chosen to ignore these results and, by dealing at the outset with the very special Zobel ladder circuits, perpetuates the erroneous impression, still widely held, that reactance filters are, in some mysterious way, linked up with these particular circuits.

In teaching students the basic ideas about filters it is necessary at the very beginning to describe the primary objectives and to emphasise the part which the study of the image parameters plays in the design process. The objective is to design a reactance network which will provide between constant, resistive terminations an insertion loss meeting a filter-like specification. There are various ways of achieving this end result, one of which is by imposing some simple restrictions upon the network and working in terms of its

image parameters. In this so-called image-parameter theory of filters, the complete insertion loss is computed as the sum of the image attenuation and various simple reflection-loss terms. An appreciation of these latter terms is essential in any understanding of the subject because they alone relate the artificial behaviour of the image parameters to the real-life properties of the insertion loss, and indicate what considerations are important in the choice of the image parameters.

Prof. Koehler omits any discussion of these reflection-loss terms beyond vague remarks that unfortunately they do sometimes exist but are to be avoided, and the student is left completely in the air. Much of the treatment of the image parameters could, with advantage, have been exchanged for an explanation of these reflection-loss terms, showing how simple they become in the special case of an image-parameter filter and how easily they lead to a systematic design procedure.

The section on equalisers is very brief (11 pages) but, nevertheless, four pages are used to describe a 27-year-old design method for lattice equalisers due to Zobel. Nowadays, a network designer would hardly ever use the method or the network.

In contrast, 100 pages are given over to the treatment of transmission lines. A preliminary chapter describes the physical properties of R, L, C and G in some detail and the following two chapters deal with the derivation and solution of the conventional transmission-line equations and with high-frequency lines. In general, this part is well written.

On the whole, the book provides little which is not already available in existing textbooks and, at the price, it seems unlikely to have a wide appeal in this country. H. J. O.

BOOK RECEIVED

Wireless World Diary, 1956. Iliffe & Sons, Ltd. 79 pages of reference material plus Diary pages of one week to an opening. Leather, 5s. 10d. Rexine, 4s. 1d.

The reference section includes licence regulations; international prefixes; data for S.W. and V.H.F. aerials, coil winding and suppression of electrical interference; useful formulae, graphical symbols and abbreviations; base connections for 600 current valves; and considerable general radio information.

Institution of Post Office Electrical Engineers

Annual Awards for Associate Section Papers— Session 1954/55

The Judging Committee has selected the following from the papers submitted by the Local Centre Committees, and prizes of £4 4s. Od. and Institution certificates have been awarded to the following in respect of the papers named:—

R. J. Francis, Technical Officer, Dollis Hill Centre—“Micro-waves and Waveguide Filters.”

P. J. Froude, Technical Officer, London Centre—“Direct Current Machines.”

W. P. Smith, Technical Officer, London Centre—“Planning a Lighting Scheme.”

R. T. Vaughan, Technical Officer, London Centre—“The Development and Inspection of the MEDRESCO Hearing Aid.”

J. H. Lawrence, Technical Officer, Aberdeen Centre—“Air-Raid Warning Sirens.”

In addition, the following papers, which were considered worthy of submission to the Judging Committee for the main awards, have been awarded a prize of one guinea each:—

W. J. Costello, Technical Officer, Middlesbrough Centre—“The No-Break Continuous A.C. Power Plant.”

E. Bauer, Technical Officer, Bradford Centre—“The Detection of Atomic Radiation in Civil Defence.”

The Council is indebted to Messrs. L. L. Tolley, W. H. Brent and W. A. L. Coleman for kindly undertaking the adjudication of the papers submitted for consideration.

H. E. WILCOCKSON,
Secretary.

Additions to the Library

- 2262 *The Teaching of Electricity*. Science Masters' Association (Brit. 1954).
The report of a Sub-Committee of the S.M.A. on the desirability and means of making it possible to utilise a particular M.K.S. system of units in School Science Teaching.
- 2263 *Automobile Efficiency*. E. T. Lawson Helme (Brit. 1951).
Describes the operation of an organised system of engine testing and tuning designed to improve the car performance and to enable the need for replacement parts to be ascertained scientifically.
- 2264 *The Modern Diesel*. D. H. Smith (Brit. 1954).
Defines and illustrates up-to-date high-speed diesel practice and discusses recent trends.
- 2265 *The Sports Car*. D. Campbell (Brit. 1954).
Analyses the engineering design of the sports car in relation to its performance on the road.
- 2266 *Practical Builders' Handbook*. A. E. D. Fryer (Brit. 1954).
Covers the whole field of building operations under headings arranged alphabetically.
- 2267 *Material Handling in Works Stores*. L. J. Hoefkens (Brit. 1954).
Makes special reference to the fork lift truck and pallet technique.
- 2268 *Fundamentals of Transistors*. L. M. Krugman (Amer. 1954).
Intended to serve the initial needs of engineering students meeting transistors for the first time. A practical treatment which, however, gives the necessary fundamentals.
- 2269 *Transistors and Crystal Diodes*. B. R. Bettridge (Brit. 1954).
A concise description of how these devices work.
- 2270 *Fundamentals of Radar*. S. A. Knight (Brit. 1954).
A basic survey of the principles underlying radar.
- 2271 *Mathematics in Action*. O. G. Sutton (Brit. 1954).
Shows how mathematics is applied to bring order and stability into the knowledge of the world revealed by observation and experiment.
- 2272 *The Complete Amateur Photographer*. D. Boer (Dutch 1954).
An introduction to the art and technique of photography for amateurs and those studying photography as a profession.
- 2273 *Exposure and the Fundamentals of Camera Technique*. W. F. Berg (Brit. 1950).
Deals practically with all the materials, accessories and conditions controlling exposure, and attempts to explain photographic theory.
- 2274 *Illumination*. R. H. Cricks (Brit. 1951).
Collects and sifts the information on light sources, notably electricity, from the photographer's point of view.
- 2275 *Retouching*. O. R. Croy (Brit. 1953).
A description of all methods of retouching, with emphasis on the latest methods.
- 2276 *The Repair of the Small Electric Motor*. K. Wilkinson (Brit. 1954).
A practical guide for maintenance men and fitters, theory and major repairs being omitted.
- 2277 *Introduction to 3-D*. H. Dewhurst (Brit. 1954).
A comprehensive survey of the various systems.
- 2278 *Fibreglas Reinforced Plastics*. R. H. Sonneborn (Amer. 1954).
A complete treatment covering the resins and glass reinforcements used in reinforced plastics, moulding techniques, inspection and testing, properties, and design considerations.
- 2279 *Modern Physics*. H. A. Wilson (Amer. 1948).
Designed to meet the needs of students up to and including the standard of an Honours Degree—includes a discussion of the quantum theory, relativity, wave mechanics and nuclear physics.
- 2280 *The Gyroscope Applied*. K. I. T. Richardson (Brit. 1954).
Explains the theory of the gyroscope and describes its practical applications.
- 2281 *Applied Thermodynamics*. A. C. Walshaw (Brit. 1953).
Designed for students studying for Part II B.Sc., H.N.C. and Diploma, and the examinations of the Professional Institutions.
- 2282 *Photo-technique*. H. J. Wells (Brit. 1954).
A reasoned introduction to the fundamentals of practical camera work.
- 2283 *Electronic Valves in A.F. Amplifiers*. E. Rodenhuis (Brit. 1954).
Written for the designer or amateur who builds his own amplifiers.
- 2284 *Interplanetary Flight*. A. C. Clarke (Brit. 1950).
A survey of the possibilities and problems of inter-planetary flight.
- 2285 *Electric Wiring (Domestic)*. Ed. E. Molloy (Brit. 1954).
A practical work for installation engineers, contractors and electric wiremen.
- 2286 *Frontier to Space*. E. Burgess (Brit. 1955).
The story of how man has extended his knowledge of the vast regions of the Earth's atmosphere which stretch above the troposphere to the frontier of interplanetary space.
- 2287 *Transistor Audio Amplifiers*. R. F. Shea (Amer. 1955).
Provides the practical fundamentals of transistor applications and shows how these may be used in the construction of audio amplifiers.
- 2288 *Servomechanism Practice*. W. R. Abrendt (Amer. 1954).
Gives material on circuitry, electrical and mechanical components, and practical problems encountered in servo design and manufacture.
- 2289 *Transistors: Theory and Applications*. A. Coblenz and H. L. Owens (Amer. 1955).
A practical guide and reference on the subject.
- 2290 *Practical Sheet and Plate Metal Work*. E. A. Atkins (Brit. 1954).
Covers the development of all the shapes that the tinsmith or coppersmith is likely to encounter.
- 2291 *Signal Venture*. L. H. Harris (Brit. 1951).
A record of the author's personal experiences as a linesman in World War I, between the wars in the Post Office and as a Signal Officer in the Territorial Army, and during World War II covering the planning and execution of the long-distance communications for the invasion of N.W. Europe.

(Continued on p. 248)

Notes and Comments

The Christopher Columbus International Communication Prize

It is noted with pleasure that the Christopher Columbus International Communication Prize was awarded in October 1955 to Sir Gordon Radley and Dr. M. J. Kelly (Bell Telephone Laboratories) in recognition of the Transatlantic Telephone Cable project.

This Award was instituted recently by the city of Genoa, Italy, as a memorial to Christopher Columbus, and is conferred each year in one of four categories—Maritime, Air, and Land Communications, and Telecommunications—to honour outstanding work that aids communication between men.

Mr. A. C. Warren, B.Sc., M.I.E.E.

To his many friends, both in the Engineer-in-Chief's Office and in the Regions, it is a particular pleasure to congratulate Mr. A. C. Warren on his promotion to Assistant Engineer-in-Chief.

After spending some four years at the City and Guilds Engineering College—interrupted by a short period of service, first in the old R.N.A.S. and then in the R.A.F.—Mr. Warren entered the Wireless Section of the Engineer-in-Chief's Office in 1920 as a Temporary Inspector. He was successful in the first open competition for Assistant Engineers (1922) and, for several years, was concerned with the development of radio transmitting stations, including Rugby, Leafield and Portishead. He became an expert in the design of high-power valve transmitters, and helped to lay the foundations of our present long-distance radio circuits; that he still looks back with great pleasure to those pioneering days is quite clear to those who have been privileged recently to visit the new Rugby Station with him. In the course of his work on the development of transatlantic radio-telephone circuits, he went to the United States of America in 1929 for discussions with the American Telephone & Telegraph Co., and it is of special interest at this time—when the transatlantic telephone cable is being laid—to note that during the meeting our American friends

outlined their plans for research directed towards the design of a transatlantic audio telephone cable. After his promotion to Executive Engineer in 1931 he took over wider responsibilities on radio planning and spent a short period as Officer-in-Charge of the Rugby Radio Station.

It was with some regret that he forsook radio in 1936 when he left Rugby to take up his appointment as Assistant Superintending Engineer in the old South-Western District, and, since that time, he has focused his attention on the wider aspects of the Department's work. He always relished new problems and, helped by his puckish sense of humour, it was not very long before he was at home and making a real contribution in his new sphere. In 1937 he became the first Telephone Manager of the Bristol Area, which was specially set up in advance of the formation of the South-Western Region, and it was due in no small measure to his efforts that the Area was able to cope so effectively with the urgent requirements arising from the large influx of staff, both from Government departments and industry, in the early stages of the war. It was no surprise to his many friends that he became Chief Regional Engineer of the South-Western Region in 1944, a post which has provided full scope for his administrative ability and his urge to get things done.

As all who have been in immediate contact with him know, throughout his career Mr. Warren has been very interested in the training of engineering staff (of all grades) in the Post Office, and there must be many officers who remember with appreciation the sound advice he has given them—advice which has always been forthright, helpful and kindly. His election to the Chair of the Western Centre of the Institution of Electrical Engineers in 1952, some 30 years after he held the Chairmanship of its London Students' Section (1922-23), was a tribute to his work for the Institution.

Many new problems await Mr. Warren in his new post, but his "apprenticeship," 16 years in the Engineer-in-Chief's Office, followed by 19 years in the field, coupled with his appetite for work and his sense of humour, will stand him in good stead, and, as always, he will attack these problems with relish. It is said that there is an even brighter glint in his eye than usual at the prospect of returning to his first home. We all wish him well for the future.

C. F. B.

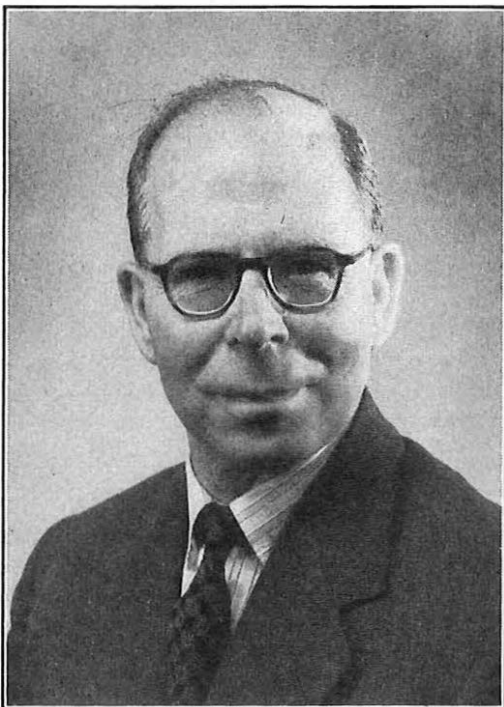

Mr. A. E. Morrill, B.Sc.(Eng.), A.C.G.I., A.M.I.E.E.

Mr. Morrill entered the Post Office in 1926 through the Open Competition for Assistant Engineers (old style). He had previously graduated in the University of London after pursuing his studies at the City and Guilds Engineering College, from which he received his Associateship. Prior to this, his education had been interrupted for four years by the 1914-18 war in which he served as a battalion signaller in the 1/20 London Regt., 47th Division. He was awarded the Military Medal for maintaining communications with the leading company during an attack at High Wood on the Somme on 15th September, 1916, the first occasion on which tanks were used. He was not content, however, with that amount of service, so he added to it four years as a Sub-Inspector in the Post Office Division of Special Constabulary.

In addition to academic studies Morrill has not neglected that other most necessary ingredient of an engineer's training, namely practical work. He spent several years in the workshops and drawing offices of electrical and mechanical engineering firms, and gained invaluable experience. His early days in the Post Office were spent in the Technical Section and the South-East External Section of the London District, followed by three years at Headquarters in the External Plant and Protection Branch,

where he had considerable dealings with the planning and provision of external plant and with its protection against electric power systems. His promotion to Executive Engineer (old style) came in 1936. He was then placed in charge of the Technical Section of the Superintending Engineer's Office, Eastern District, at Cambridge, and this post embraced the whole range of engineering work, both internal and external, dealt with in that office. In 1938 he became the Sectional Engineer and later Area Engineer of the Colchester Section, where he broadened his knowledge and experience still further, particularly in the field of staff management in which he is now so much at home. Welfare of the staff has always been of major concern to him and he served for four years on the Engineering and Stores Department Whitley Council, including two years as Chairman of the Staff Side at the time the recently superseded report of the Committee on Promotion was produced. He was promoted in 1940 to Regional Engineer in the South-Western Region, where he had ample opportunity to apply his extensive knowledge of external plant to the carrying out of a large programme of works necessitated by the last war. He has served on the Regional Whitley Committee for some years and takes a keen interest in the activities of the Regional Headquarters Sports Club, of which he has been Chairman since its formation in 1941.

His spare-time occupations include an interest in the game of bowls and an active participation in planning the rebuilding of the Boulevard Congregational Church,



Weston-super-Mare, which was destroyed by fire during the last war.

Morrill's amiable but confident manner, coupled with his sympathetic but shrewd handling of staff matters, have made his recent promotion to Chief Regional Engineer of the South-Western Region welcome news to his colleagues, who wish him well in his new post.

D. E. B.

I.P.O.E.E. Appointments

We record with pleasure that the Engineer-in-Chief has appointed Mr. D. A. Barron, M.Sc., M.I.E.E., Assistant Engineer-in-Chief, to be Chairman of Council of the Institution of Post Office Electrical Engineers. In addition he has been appointed Chairman of the Board of Editors of the Journal in succession to Col. J. Reading, M.B.E., E.R.D., whose resignation was announced in the last issue of this Journal.

To both posts Mr. Barron brings recent experience of the Institution's activities, having served as Treasurer of the Institution and Chairman of the Institution's Library Committee from 1951 to 1955 and as a member of the Board of Editors of the Journal from 1950 to 1954.

Premiums for Technical Writing

The Radio Industry Council's scheme for awarding premiums for technical writing is now in its fourth year. The objective is to encourage the writing of articles to make more widely known British achievements in radio and electronics. Up to six premiums of 25 guineas each will be awarded each year to the writers of published articles which in the opinion of the Council's panel of judges are likely to enhance the reputation of the Industry.

Any writer will be eligible who is not paid a salary wholly or mainly for writing and not earning 25 per cent. or more of his income from fees for articles or from book royalties.

Writers are invited to submit published articles (five copies of the journal, or of the relevant pages, proofs or reprints), together with signed declarations of eligibility, to the Secretary of the Radio Industry Council, 59 Russell Square, London, W.C.1, requesting consideration for an award. Articles will be considered for awards at the close of each year and the results announced early in the new year; all entries must reach the R.I.C. offices before the close of the year.

Articles published in this Journal are eligible for the awards; it will not, however, be necessary for writers of articles published in this Journal to submit copies to the Secretary of the Radio Industry Council when requesting consideration for an award, as copies of each issue of the Journal are supplied to the members of the panel of judges.

Journal Binding

This issue of the Journal completes Vol. 48 and readers wishing to have the volume bound should refer to p. 260 for details of the facilities available.

Additions to the Library—continued from p. 246.

2292 *Electrons, Atoms, Metals and Alloys*. W. Hume-Rothery (Brit. 1955).

Presents the general application of electron theory to the structure and properties of metals and alloys, in the form of a dialogue.

2293 *Automatic Transmissions*. Commercial Trades Inst. (Amer. 1955).

Endeavours to satisfy the demands of the serviceman and the student, and covers principles and maintenance.

2294 *Amplitude-frequency Characteristics of Ladder Networks*. E. Green (Brit. 1954).

Deals with the synthesis and analysis of filter-type networks by means of modern network theory.

2295 *Physics of Lubrication*.—British Journal of Applied Physics (Brit. 1951).

A symposium held in 1950.

2296 *Loudspeakers: the Why and How of Good Reproduction*. G. A. Briggs (Brit. 1955).

Intended for those requiring good reproduction, and who are therefore interested in the loudspeaker and how it works and how results may be improved.

(Continued on page 260)

Regional Notes

London Telecommunications Region

DAMAGE RESULTING FROM FRACTURE OF WATER MAIN

Early on the morning of Sunday, 9th October, the S.E. Area Maintenance Control received advice that one trunk, one junction and two subscribers' distribution cables showed signs of breakdown. This information linked up with a report of a water-main burst outside the Oval underground-railway station.

Inspection of the site revealed that a 36-in. main carrying water at a pressure of 75 lb./sq. in., 16 ft. below the road surface, had failed at a point adjacent to two interconnected manholes through which some 50 cables are routed. The large volume of water released had lifted the heavy reinforced concrete road over a large area, flooded adjacent roads for some 200 yd. in all directions and left a crater of a size and depth reminiscent of many seen during the war.

Examination of the cables was impossible owing to the presence of water and gas from fractured mains. An endeavour was made to restrict further damage to the cables by injecting carbon-dioxide gas on both sides of the "incident." After 12 hours' excellent work by the Metropolitan Water Board's contractors and the South Eastern Gas Board, reasonably safe access to the manholes was obtained and, after pumping, it was found that the deeper manhole contained ballast to a depth of approximately 4 ft., which had entered via the shaft and a spare six-way duct that had been damaged. The majority of the cables were buried beneath the ballast but the structure of the manhole appeared sound. Several cast-iron pipes passing through the crater were suspended on the cables that they contained. The failure of the cables was evidently due to their having fractured when displaced by the flow of water and it was fortunate that the faults were not in the lower manhole, where the conditions would have made work impossible.

The renewal of 240 yd. of 540/20 trunk cable was put in hand, the other cables being dried out to restore service temporarily. One joint, when dried, required a sleeve 16 ft. in length, renewal of the cable being impracticable. At a later stage a 24/40 carrier cable and an additional subscribers' distribution cable failed.

Meanwhile, the contractors had removed debris and prepared the excavation for the renewal of the damaged main. This revealed damage to 36-in. and 18-in. gas mains and leaks in several adjacent water mains. The renewal of the damaged sections was rendered difficult by the congestion of services at this point and in view of the disturbance of the subsoil all mains will be supported on pillars erected on a concrete base to be put in at approximately 25 ft. below the road surface.

The removal of ballast from the manhole proved to be a tedious job, but eventually some 12 yd. were shifted by bucket via the manhole shafts and an opening in the manhole wall, made by removing the end section of the damaged six-way

duct. The clearance of stoppages in spare ducts is now in hand and will be followed by permanent restoration of the affected cables.

The illustration gives some idea of the congestion in part of the excavation at the scene of the incident. The water main which failed is lower than and to the right of the manhole shaft, the duct route is again lower and beyond the shaft. Other services, including drainage and electricity, do not appear in the photograph.

R. V. H.

CABLING FOR TELEVISION HOUSE

In April, 1955, the Air Ministry vacated Adastraal House, their London home for many years, and almost overnight a small army of contractors moved in to convert the building into Television House for the Independent Television Authority.

The new tenants had agreed to use existing telephone switchboards and cabling but it soon became necessary to plan new switchboards and scrap the existing block wiring in order to ensure satisfactory working under the new conditions.

It was decided to retain and rearrange the old distribution frame and provide a 1,400-pair cable to cater for ultimate requirements.

The importance of easy access to distribution points was quickly recognised to be one of the first considerations for such an installation, and after many visits and discussions with the architects a suitable plan was evolved.

In addition to cables to serve the subscribers within the building, the planning and provision of coaxial cables, in conjunction with the E.-in-C.'s Office and the Regional group of the L.T.R., presented no small problem. Proposed routes had to be surveyed quickly and the facilities offered by a subway were utilised to accommodate these cables. Eight 4-in. steel pipes were used to provide an entry into the building for the cables, and over the short distance of 7 ft. two separate wayleave consents had to be negotiated with the responsible authorities before work could proceed.

At the "lead-in" point it was necessary to break through an 18-in. brick wall, and a condition was imposed that the cutting of the holes would have to be carried out by drilling through the brickwork. A 5-in. rock drill, mounted on a tripod, with sights on the barrel and actuated by a compressor, was obtained and the contractor erected special staging within the subway to carry out the job.

After each hole had been cut, a 4-in. steel pipe was set to take up its position to form two rows of four pipes inside the building. The setting of these steel pipes called for the expert use of a Crow-Cramp in order to get the required bend in such short lengths of pipe.

The job, which at first appeared to be "just another lead-in," was satisfactorily completed in about a week.

S. C. C.

North-Eastern Region

U.A.X. No. 12—EXTENDED CAPACITY

Details of a scheme to increase the capacity of a U.A.X. No. 12 on a shared-service common-metering basis were published in December, 1954. This was arranged by using level 3 as a hypothetical level for the Y subscribers, who were given numbers in the 300 group with the same tens and units digits as their X partners in the normal 200 group.

By providing an additional A unit, shared service with separate metering can be provided for a maximum of 25 additional subscribers. The traffic carrying capacity of the exchange is increased by the four selectors in the unit.

A scheme providing for separate metering was first tried at Aberford in the Leeds Area, where the five existing units (two A, two B and one C) were moved approximately 9 in. along the cable trench to enable a third A unit to be added *en suite* just inside the door. All selectors, including those in the added unit, were modified to include an additional relay operated by the initial digit 3.

The power panel was suspended on hinges, and provided with a castor riding on a curved metal strip fixed to the floor, so that the panel could be swung out of the way to give working space when required. This scheme was not regarded as satis-

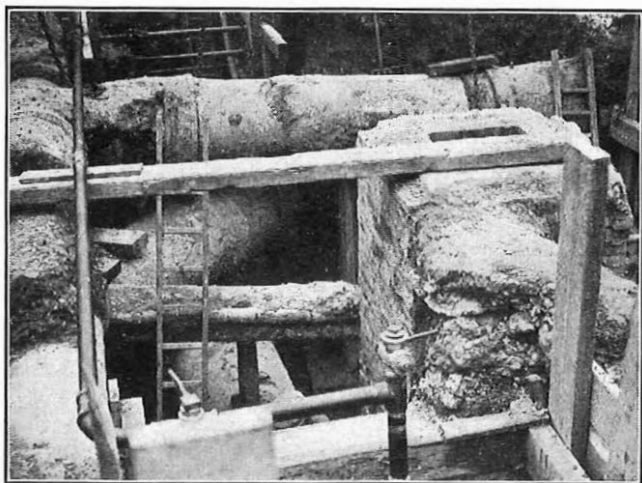

EXCAVATION AT SITE OF DAMAGED WATER MAIN.

factory as the added unit blocked egress from behind the units at the door end.

At Spofforth, also in the Leeds Area, a more ambitious experiment has been tried. With the agreement of the planning authority, a battery hut was erected on spare land at the rear of the building and the battery rack and batteries were moved into it. The hut was fitted with a roof light and a 5-A. power point. The space vacated was used for the provision of a third A unit located close to, and at right angles to the wall. There is adequate space for a third B unit should this be required, giving a possible addition of 45 calling equipments. The multiple and miscellaneous cables were carried from the main suite of units in locally-made rectangular-section metal troughing, the roofs of the units being cut to allow entry of the cables.

The advantages of the scheme are:—

- (1) More rapid clearance of U.A.X. No. 12 order lists.
- (2) Deferment of capital expenditure on sites, buildings, external work and internal plant. The U.A.X.s No. 12 concerned will ultimately require to be replaced, but the work will be spread over future years, when the impact of work to clear order lists is subsiding.
- (3) Serviceable U.A.X. No. 12 units are kept in use instead of being recovered with no likelihood of re-issue.
- (4) Reduction of the demand for U.A.X. No. 13 units.
- (5) Better disposition of engineering staff is effected by the reduction in peak provision.

The disadvantages of the scheme are similar to those of the common-metering expedient, viz.:—

- (1) N.U. tone cannot be applied to numbers in the 300 range.
- (2) If service to one of a pair of sharing subscribers ceases, N.U. tone cannot be given on the ceased number.
- (3) An exclusive line in the 200 range can be obtained by dialling the equivalent number in the 300 range.
- (4) If it is decided that exclusive service can be given to a sharing partner his number would have to be changed.

In order to exploit the scheme to the full it is desirable that there should be spare multiple in the normal numbering range, and/or potential party subscribers existing. Where necessary the numbers of existing Y partners can be changed into the 300 series, so releasing numbers in the 200 series for further pairs of subscribers. At Aberford there were two spares but a further eight were obtained by changing existing Y subscribers from the 200 to the 300 group, thus providing a total of 10 spares in the 200 group available for 20 new shared service connections. The number changes were effected without complaint from the affected subscribers.

At Spofforth the cost of providing one additional unit (excluding the cost of the unit itself) approximated to the annual charge of a U.A.X. No. 13, so in general it may be said that the expedient is justified for periods of service in excess of one year. In addition, the hut will have a recovery value.

The scheme is especially attractive for many U.A.X.s No. 12 with slow development, because it would defer the expensive conversions to U.A.X. No. 13 for worthwhile periods. It is also useful for deferring conversions until such problems as proposed boundary changes or the possibility of amalgamation with other exchanges are resolved.

The Aberford and Spofforth extensions have been in service for some months and there have been neither service complaints nor engineering difficulties.

J. J. P.

Midland Region

36-WAY OCTAGONAL LEADING-IN DUCTS AT BURTON-ON-TRENT EXCHANGE

An interesting method of construction has been adopted at Burton-on-Trent exchange to ensure that the octagonal leading-in ducts are watertight.

The exchange is situated near the River Trent and the subsoil is gravel. At high-water periods the ground on which the exchange stands becomes waterlogged and it was essential, therefore, that the octagonal duct line should be of watertight construction. In order to achieve this it was proposed initially that the concrete trough should be tanked with asphalt and a protective skin of $4\frac{1}{2}$ -in. brickwork provided. Experience in this Region, however, has proved that asphalt tanking is not

entirely satisfactory, and so it was decided to construct the trough in vibrated concrete and use patent PVC water barriers wherever joints in the concrete were found to be necessary.

The base of the trough and 6 in. of the walls were constructed of vibrated concrete 6 in. thick of an approximate mix of 8 : 1. A 4-in. PVC water barrier was set in the 6-in. side walls with 2 in. projecting above the surface. The walls of the trough were then brought up in the normal manner and vibrated as placed. The concrete trough was taken through the cable chamber and manhole walls so that it was continuous from the manhole to the inside of the cable chamber. The octagonal ducts were then laid in the trough in the normal manner and on completion a 6-in. roof of vibrated concrete was placed on the trough. Water barriers were not used at the junction of the roof and the side walls, but concrete construction joints were used instead of rebates. It was considered that this point would be above the expected water level at high-water periods. In all other respects the construction was normal, except that the $\frac{1}{2}$ -in. diameter steel bars in the base were placed longitudinally at 6-in. centres and transversely at 2-ft. centres. The work was completed in June, 1955, and up to the present gives every indication of a satisfactory watertight construction.

A poker vibrator operated by a small petrol engine was used throughout. The mixing of the concrete was carefully carried out, the water content being kept to a minimum for the mix required, a water/cement ratio of 0.48 being maintained. Test cubes of the concrete were taken as the work proceeded and were found to be of a dense nature free from voids. The aggregate used was $\frac{3}{4}$ -in. to $\frac{3}{8}$ -in. crushed gravel and the sand $\frac{3}{8}$ -in. down. The compressive strength after 14 days averaged 6,100 lb.

The additional cost over normal construction was approximately 15s. per foot run, which is very much cheaper than the asphalt tanking originally considered. It also avoids the additional excavation necessary to provide the $4\frac{1}{2}$ -in. brickwork protective skin to the asphalt tanking.

Vibrated concrete and PVC water barriers for the concrete trough, when octagonal ducts are to be provided in wet situations, appear to be a satisfactory alternative to the standard method of construction where heavy water pressure is anticipated.

J. E. B.

Northern Ireland

U.A.X.s No. 7—MODIFICATIONS TO INCREASE CAPACITY OF JUMPER FIELD

Recent equipment extensions at the four U.A.X.s No. 7 in the Belfast Telephone Area have produced a problem which has always been inherent in the design of this type of exchange; namely, how to accommodate the large increase in the inter-rack jumpers.

As is well known, the U.A.X. No. 7 does not include an I.D.F. Each linefinder group of 100 lines is associated with a particular final selector group and the linefinder and final selector multiples are terminated side-by-side on connection strips at the top of the A rack; subscribers being connected by strapping adjacent rows of tags. This system cannot be fully applied, as to do so would suggest a uniform calling rate of subscribers and loading of groups. When variation occurs, the traffic can be evenly distributed only by the use of jumpers between A racks, and it was to accommodate these jumpers that the original inter-rack jumpering facilities, shown in the first illustration, were provided. In the exchange shown in that illustration—Holywood—a 400-line extension is in progress, following which extensive use will be made of shared service with separate metering. A new rack is shown in foreground.

The standard jumpering facilities might have served the present multiples in the three other exchanges (average 1,400 lines) but for the extensive use of shared service with separate metering. It is rarely possible to connect two sharing subscribers without the use of at least one external jumper, as subscribers are frequently allocated partners in different final selector groups. Also, modified line equipments are not always available in the group associated with either of the partners.

On recent extensions, in view of a proposed further increase in the use of shared service, it was decided to enlarge the jumper runs. It was apparent that it would be of little use

South-Western Region

STEAMING OUT HESSIAN-PROTECTED CABLES

Readers who have travelled between Bournemouth and Southampton along the A35 road will have passed through the old priory town of Christchurch. If this were during the holiday season they will know what a traffic bottleneck Christchurch can be, partly due to the humpbacked bridges over the two branches of the River Avon. All east-bound M.U. & C.J. cables from Bournemouth pass through this part of Christchurch, which is known as Purewell, in two duct lines, a 3-way duct on the north side and a 6-way on the south. Over the bridges the pipes are 3½-in. steel because of lack of cover.

The Bournemouth-Southampton No. 4 and 5 carrier cables were installed in one bore of the 6-way duct line in 1938, and are hessian protected. A fault developed on the No. 4 cable recently and was proved to be in one of the 184-yd. lengths of steel pipe over one of the bridges. It was found impossible to rod over more than 30 yd. from either end and the faulty cable was substituted in the only remaining spare way of the 6-way nest.

All attempts from both ends to withdraw the faulty length, first by motor winch and then by chain puller, failed and only resulted in the cable stretching 4 to 5 yd. and ultimately breaking outside the cable grips; thus it became obvious that something abnormal was holding the cable. It was known that the cables were drawn in together and might have become twisted, and, from previous experience, possibly stuck together. It was also known that the pipeline deviated considerably from a straight line due to the humpbacked bridge, passing over or under other plant, and the swing in the road. As an alternative to tackling the difficult job of cutting the steel, it was decided to substitute the No. 5 cable and attempt to draw out both cables. This, however, met with no greater success; neither cable could be moved, either by pulling both together from each end in turn, or one cable from each end, i.e. in opposite directions at the same time, although, it is estimated, a pull exceeding 3 tons was applied to the cables.

There was a road depression on the bridge immediately above the steel pipes, at a point where the pipes were in flat formation, almost in the centre of the road with only 2 in. of concrete and 1 in. of asphalt as cover. It appeared possible that the steel had been crushed or had sunk due to subsidence of the arch of the bridge, but the Divisional Surveyor's examination underneath the arches found no sign of a collapse.

It was then decided to open the road at the depression, examine the steel pipes, and, if they were in good condition, open the steel pipes and cut the cables in the hope that the two halves could be withdrawn. The police would only permit this to be done after midnight on Saturday and subject to automatic traffic lights being used. Although working at night, it did not take long to clear the top of the pipes, and they were found to be in perfect condition. It was then necessary to decide which pipe to open, and this was done using a wire overground between the manholes and the required steel pipe. A Skilsaw powered by a compressor was used to cut the steel pipe, and it was then prised open sufficiently to allow the cables to be cut. It was noticed that the cables were stuck fast together and to the pipe, and a crowbar was necessary to move them. Attempts to draw out the cut cables again failed; and, unfortunately, the ends of both cables in both manholes were lost due to excessive stretching. It was now certain that both cables were stuck throughout their length.

The opened pipe was closed in and covered by a half-section of 4-in. steel and concrete.

The problem now was how to free the cables. The Post Office chemists were consulted and suggested a solution of water and paraffin, or steam. Steam had previously been considered locally and enquiries already made from local firms about the possibility of hiring a steam boiler. This was obtained and brought to the site on a low-loader, together with numerous lengths of screwed ¾-in. conduit, which were used to extend the rubber hose steam outlet from the boiler, a suitable connector being made to join them together.

Steam at about 35 lb./sq.in. pressure was raised and the conduit pushed up the pipe to a maximum of 35 yds. The

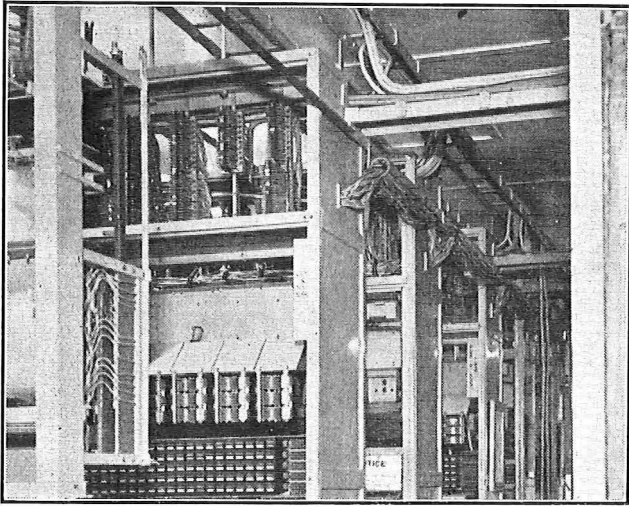

USUAL ARRANGEMENT OF JUMPERS IN U.A.X. NO. 7.

to increase the diameter of the jumper rings fitted between racks unless something was done to enlarge the holes in the A-rack end panels through which the jumpers emerge. An attempt was made to cut a larger hole at this point but the obstruction caused by the existing jumpers and, in some cases, the risk of earthing the negative bus-bar with the cutting tool caused the idea to be abandoned and the problem solved by the simple device of removing the end panels altogether. A lead was given in this connection by the fact that units used on recent extensions had been supplied without covers and end panels. After removing all fixing screws, two horizontal cuts were made between the side edge of the panel and bottom and top edges of the jumper hole. With this rectangular piece removed, the panel was withdrawn without fouling the existing jumpers. A hacksaw and tinsmith's small shears were found adequate for the job. The effective length of the shear handles was increased by the use of two short lengths of ¾-in. conduit.

The inter-rack jumper runs were enlarged by substituting Jumper Rings No. 9 for the existing small rings, but it was necessary to turn the rings through an angle of 90° to their fixing flanges and it was found that they could be twisted fairly easily when cold.

These measures effectively relieved congestion and they are considered adequate for up to 1,600 lines capacity. The main feature of the work was that existing jumpers did not require to be renewed.

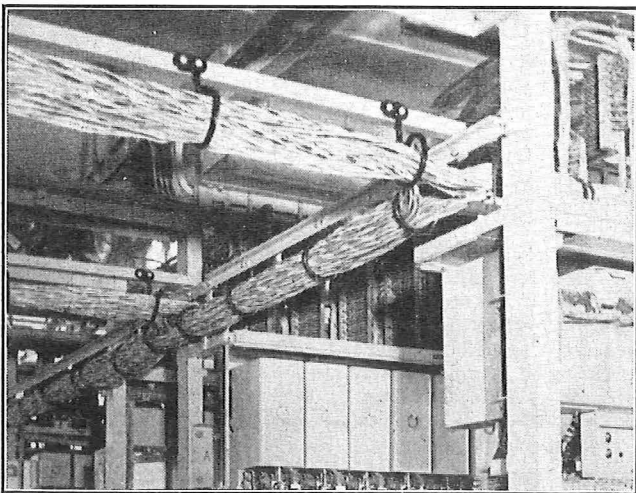

ENLARGED INTER-RACK JUMPER RUNS AT DUNDONALD EXCHANGE.

The second illustration shows the completed work at Dundonald exchange, which has 1,200 lines capacity, including 720 shared-service subscribers with separate metering.

W. G.

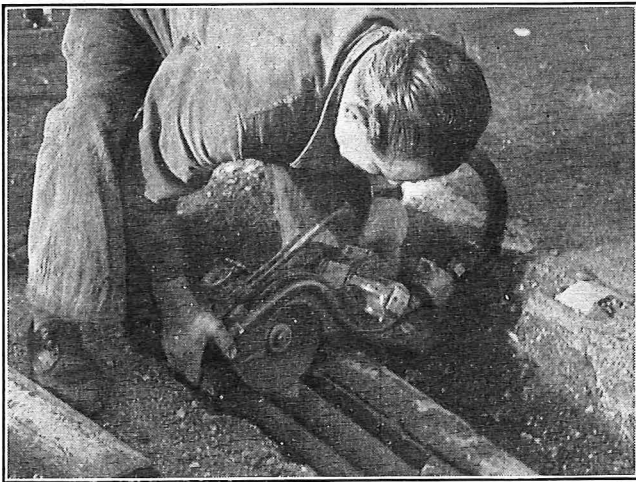

CUTTING THE STEEL PIPE.

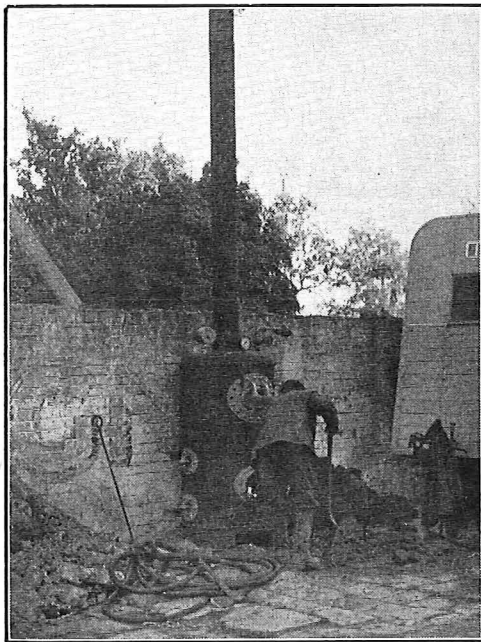

THE STEAM BOILER.

hope that steam would penetrate to the distant manhole proved too optimistic, due, it was found later, to pockets of water at low-lying points in the pipe.

It was then decided to open the pipe at the eastern approach to the bridge, a distance of 45 yds. from the manhole, and also to remove the last section of pipe entering this manhole in order to attach the cable grips. The steam conduit was pushed through the 45 yds. and after three hours of heating at a pressure varying between 40 and 50 lb./sq.in. the cables were withdrawn with comparative ease and a small mop drawn through which brought out a considerable amount of bitumen and hessian.

The remaining part of the pipeline was dealt with by reopening on the bridge and by a third opening on the western approach to the bridge. Steam was piped overground to reach the middle sections and the same operations carried out as in the first section. After all cable had been withdrawn the pipeline was rodded, but it was found that nothing larger than a 2-in. rope could be drawn through. Attempts to clear the pipe were made by means of barbed wire threaded through a length of chain, but without success. The steam conduits were again used by tying them to the 2-in. rope and drawing them into the pipe. A full-bore barbed-wire swab, followed by another swab soaked in paraffin, was then pulled through and brought out more hessian and bitumen which the smaller swab had passed over. Finally a 9-in. mandrel was drawn through.

It will be appreciated that this work occupied many man-hours but, bearing in mind the cost of laying a new pipe over such a difficult section and the value of the scrap cable, it was an economic proposition.

W. C. M./G. A. W.

Home Counties Region

UNUSUAL UNDERGROUND CABLING WORK

It was necessary recently to provide a relief cable at Luton and at the same time to make allowance for future cabling and jointing work that would become necessary in a few months' time when the exchange was extended. A 900-pair cable was required between two manholes, with approximately 5 yds. of "slack" cable left at an intermediate point, which would become the new lead-in manhole.

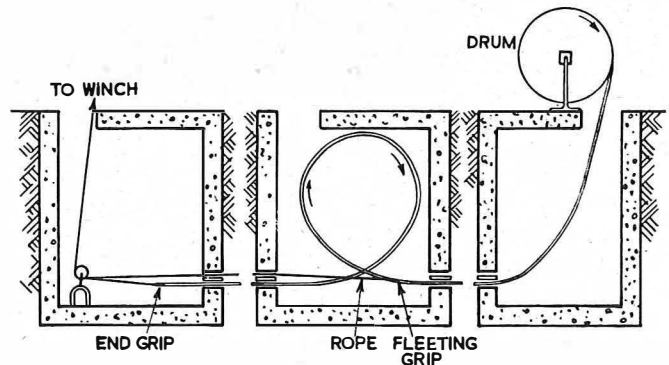

METHOD OF DRAWING-IN THE CABLE, SHOWING THE LOOP LEFT IN THE CENTRE MANHOLE.

The sketch shows the relative positions of the manholes and also the cabling arrangements. The intermediate manhole was non-standard, approximately 10 ft. long, 10 ft. deep and 3 ft. wide. The duct line was at the bottom of the manhole. No anchor irons were fitted. The section lengths on either side of the manhole were 96 yds. and 28 yds.

Cabling operations were commenced and the cable was pulled into the intermediate manhole. The "end" pulling grip was then removed and a second rope passed through a spare bore from the pulling-in manhole to the intermediate manhole and coupled to a "fleeting" grip which was passed over the cable. Pulling-in continued, using the second rope and fleeting grip, and as the cable was pulled into the intermediate manhole the end was turned so as to form a large loop. When sufficient cable had been fleeted the end grip was reconnected and pulls were then made alternately on the fleeting grip and the end grip. As the cable was pulled into the intermediate manhole by the fleeting grip the slack was pulled out by the end grip. The large loop in the intermediate manhole was left adequately supported and ready for future use. Greasing the cable was considered and the first 30 yds. were lightly greased at the feeding-in manhole but were re-greased adequately at the intermediate manhole as the cable entered the short section to the pulling-out manhole.

Two men were employed in the intermediate manhole to man-handle the cable so as to maintain the large loop free from sharp bends. A third man was stationed at this point and controlled pulling-in operations. No additional staff were necessary at the other points. The work was carried out in the centre of the town where the normal hazards of traffic, pedestrian and vehicular, had to be contended with.

The method used, which proved entirely satisfactory, had not been employed previously but will, no doubt, be remembered by the staff taking part who would not hesitate to use it if faced with a similar cabling problem.

C. W. R.

UNUSUAL USE OF A FORK LIFT TRUCK

A fork lift truck was used recently in the erection of a cable-drum hoist at Aylesbury.

The cable-drum hoist was constructed of a 6 in. by 5 in. rolled-steel joist, 12 ft. long, with two "A"-pole supports (36-ft. stout poles cut down to 22 ft. 6 in.). The supports were not

perpendicular but sloping inwards at an angle, giving stability and an adequate distance between the supports for lorries to pass between them.

The "A" poles were cut, scarfed and the complete hoist fitted and assembled on the ground. Pole holes were positioned so that when the top of the hoist was raised it would pivot on the lower butts. Instead of the conventional method of derrick erection it was decided to employ a fork lift truck to raise the hoist to such a position that a direct pull from a

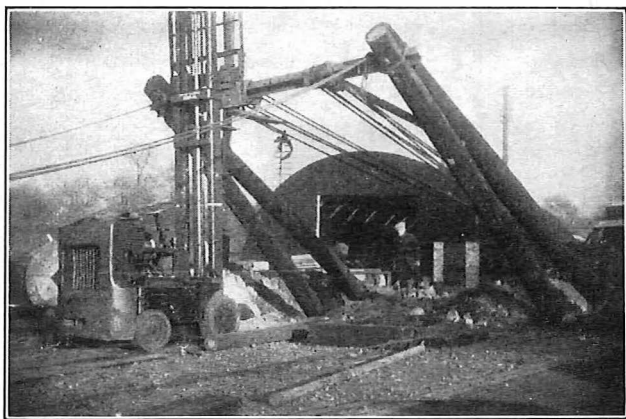

ERECTING THE CABLE-DRUM HOIST WITH A FORK LIFT TRUCK.

lorry was able to "take over" and pull the hoist into a vertical position. The lift by the fork truck had to be made in several steps; the partly-raised hoist was held in position by means of struts during the repositioning of the fork lift truck; this was necessary between each step.

F. E. L.

POST OFFICE SCIENTIFIC EXHIBIT

To stimulate local interest in the opportunities which are available for interesting careers in industrial and commercial undertakings in the Portsmouth district, the City of Portsmouth College of Technology recently staged an exhibition of scientific and industrial interest, representative of local undertakings. The Telephone Manager, Portsmouth, was invited to participate.

When first considering what form the Post Office exhibit would take, it was decided to try to show the modern trend of telecommunications equipment, with an eye to future development, by means of a "live" topical exhibit with moving parts and having demonstrators, rather than a more usual static display.

With the kind co-operation and very practical help of the Research and Radio Branches, Dollis Hill, from whom the equipment was borrowed, an interesting stand was provided which proved to be one of the most successful on show.

The exhibit comprised, firstly, the working model of a quartz-crystal clock, with descriptive notice, together with several annotated photographs of quartz cutting and lapping machines, and actual specimens of natural uncut quartz crystals, partly prepared quartz blocks, and examples of different types of quartz oscillators in their final state.

Secondly, a display model showing the principle of operation of an electronic exchange, by means of sets of coloured lamps and cold cathode tubes, operated manually by keys, was used by the demonstrators to explain the possible development of telephone exchange construction and operation in the future. Other items of equipment included a binary-scale counting unit and a dekatron counting unit, connected to a dial telephone to illustrate the uses of such counting devices in industry.

The exhibition was opened by Sir Henry Tizard, G.C.B., M.A., F.R.S., who, with others, showed great interest in the Post Office stand.

The exhibition lasted for five days, and visits to three automatic telephone exchanges, within the Portsmouth City boundary, were arranged at certain times of the day for any visitors to the Post Office stand who were interested.

Other exhibitors included H.M. Dockyard, Portsmouth, the Admiralty Signal and Radar Establishment, the Central

Electricity Authority, the Southern Electricity Board, British Thomson-Houston Co., Ltd., and the General Electric Co., Ltd.
D. R. F. D.

Scotland

THE LAST POST OFFICE INLAND MORSE TELEGRAPH CIRCUIT

The Outer Hebrides have recently become front-page news because of the Government proposals to install a rocket range. Opposition to the scheme comes from a section of the population who wish to retain the old way of life, but the old way of life continues to vanish. Motor cars, tractors, aeroplanes and telephones have come to stay, and progress and development in these things are inevitable.

There are many on the Long Island who will regret the passing of the last inland morse telegraph circuit operated by the Post Office. A decision has been made to recover this circuit, which linked the islands of the Outer Hebrides. Records of its early history have been lost, but the linking of Barra to South Uist by submarine cable in 1884, and, two years later, the laying of the Harris-North Uist submarine cable, probably caused as much stir as the proposed rocket range does to-day.

The importance of the circuit can be judged from the traffic carried. Twenty years ago, when Castlebay had a flourishing fishing fleet, it was not unusual for the local Post Office to handle between four and five hundred messages a day. Decline of the herring fishing industry and the introduction of the telephone in 1938 caused a gradual reduction in telegraph traffic. It became more and more difficult to find staff who could be trained as competent telegraphists and, eventually, in October, 1954, a fault in the Benbecula-South Uist submarine cable put the circuit out of use. The faulty cable was not repaired, telegrams were passed by telephone, and now the apparatus is to be recovered and the lines used for other purposes.

The circuit has been used for various systems, Wheatstone, simplex, duplex and A.B.C. The line throughout the length of the Long Island consists of 40 miles of very exposed overhead route interconnected between the islands by submarine cable having a total length of 18 nautical miles. This served the Post Offices at Castlebay, Lochboisdale, Grogarry, Creagarry and Lochmaddy. A further length of 11 miles of submarine cable connects North Uist with the island of Harris.

The old morse telegraph had its advantages. In small offices, consisting perhaps of a general shop with no space for a silence cabinet, secrecy was ensured, and the telegraphist could even attend to other matters while taking a message. A transmission standard much lower than that required for telephone circuits could be tolerated. The nests of hooded crows, salt spray from the Atlantic, and other maintenance hazards were not as harmful to simplex telegraph as they would be to a complex country satellite. There is perhaps something to be said for the old way of life.

J. S. G.

THE TRANSATLANTIC CABLE LANDED

On the 5th and 6th September, the shore ends of the receive and transmit transatlantic telephone cables were taken ashore, and buoyed two miles out at sea, ready to be picked up by H.M.T.S. *Monarch*. The operation was carried out by H.M.T.S. *Iris* and Scotland West Area staff.

As it had proved impracticable to excavate a trench under water to a point where the cables would be free from exposure, the novel expedient of two 6-in. steel pipes was employed. These were laid from above high-water mark into the sea, fixed in position with concrete, and then covered with several feet of broken rock. The cables were thus protected from wave action on the beach.

The shore ends consisted of the central core with three different types of protection, the overall diameter varying from 1.84 in. at the seaward end to 2.26 in. at the anchor.

The central copper conductor, 0.1318 in. diameter, surrounded by three copper tapes, 0.148 in. \times 0.0145 in., was covered with a solid layer of polythene 0.23 in. thick. Over this were wound the six return copper tapes, 0.32 in. \times 0.016 in., covered with an overlapping winding of teredo copper tape, 1.75 in. \times 0.003 in., and then covered with a 0.1 in. thick layer of polythene.

The 1½ nautical miles of cable at the seaward end were served with jute and armoured with 12 × 0.3 in. mild-steel wires, protected with two servings of impregnated jute. The 1,218 yds. at the landward end were protected with an overlapped cotton tape over the polythene, and a 0.18 in. thick lead-alloy sheath. The armouring over this was increased to 16 × 0.3 in. mild-steel wires. The last 165 yds. at the landward end included an outer polythene sheath, 0.1 in. thick, over the lead. This served as the final outer covering when the armouring had been stripped from the end of the cable as far as the anchor point.

The actual landing was carried out with the Clyde "puffer" *Glen Aray*, to which the cable was transferred from H.M.T.S. *Iris*, and coiled in the hold. The armoured cables were drawn ashore from the puffer through the steel pipes, by Area staff using a winch. When a sufficient length was ashore to reach the power-feeding cabinet without a joint, the cable was laid out on the shore and the armour stripped as far as the anchoring point. A clamp, specially made to a Bell System design, was fastened to the armouring remaining on the seaward portion of the cable to anchor the cable to the shore.

The stripped end was drawn through the duct into the station by men working in a passage without windows. Their work was very satisfactorily controlled with the aid of a public address system, the microphone being located at the point where the cable entered the duct. As the stiff coaxial cable was covered with polythene and a lead sheath, extreme care was necessary in handling the loop laid out on the shore where it entered the duct. A number of light two-wheeled "skates" were used to carry the cable along the passage floor and proved very handy.

H.M.T.S. *Monarch*,* after laying the last section from Rockall Bank,* picked up the buoyed end of the receive cable and made the final splice on 26th September. Power

was turned on at 19.08 hours the same day, and speech from Newfoundland was heard. Transmission measurements commenced immediately.

The end of the transmit cable lies in the sea, ready to be picked up and spliced to the main length of cable to be laid by *Monarch*.

J. H. R.

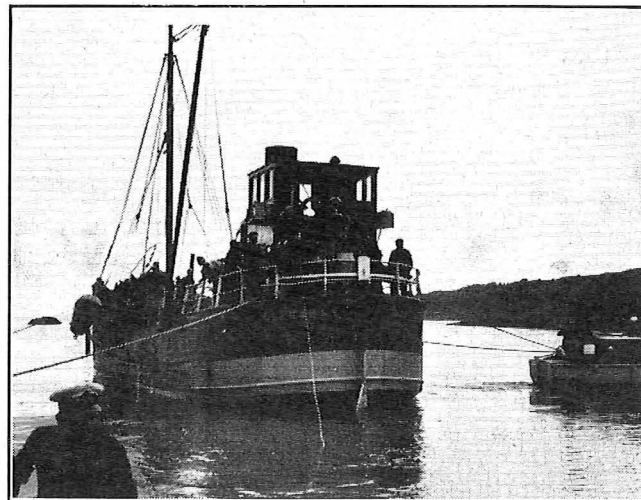

LANDING THE CABLE FROM THE "GLEN ARAY"

*Described in "Completion of the First Transatlantic Telephone Cable," p. 239 of this journal.

Associate Section Notes

Darlington Centre

The officers and committee for the present session are: *Chairman*: L. M. Airey; *Vice-Chairman*: A. Snowden; *Treasurer and Librarian*: B. Midcalf. *Committee*: R. W. Cowen (Senior), D. E. Dodds, G. A. Garry, T. L. M. Hebron, S. Little, J. McManners, R. Moore, H. Milburn, S. Pumford and J. Ronaldson. *Auditors*: P. Dodds and A. S. Hyatt. *Local Secretary*: C. N. Hutchinson.

It is hoped that the following programme, which has been arranged for the 1955/56 session, will appeal to our Centre members and ensure good attendances at the meetings:—

8th November.—"Electricity in the Chemical Industry,"

G. A. Whitton, A.M.I.E.E. (I.C.I., Ltd.).

29th November.—"The News in the Newspapers," W. A. Myers (Chief Reporter, North of England Newspaper Co., Ltd.),

14th December (at Middlesbrough).—"Electronics in Telephone Exchanges," J. Lawrence, M.I.E.E.

10th January.—"The New Broadcasting System." B. V. Northall, A.M.Brit.I.R.E.

7th February.—"Some Peculiar Maintenance Problems I have Encountered," G. B. G. Hart, A.M.I.E.E.

13th March.—"Motor Sports," with Film Illustrations, R. Lawson.

10th April.—"Frigidaire," E. J. Naylor (H. C. Trolldahl Ltd.).

More of our Centre members have been promoted, including our Chairman for the 1953/55 sessions, Mr. N. V. Allinson, and in consequence are now members of the Senior Section. We congratulate them and appreciate the fact that they will still follow the Centre's activities. C. N. H.

Newcastle Centre

A meeting was held in June to determine whether sufficient interest in the Associate Section existed to enable the Centre, dormant for several years, to be restarted. The response was far beyond expectation and, striking while the iron was hot, officials and a committee were elected before the meeting closed.

Membership to date is 124, almost three times greater than ever it was as the old Junior Section.

Four local visits were arranged: one in August to a cable factory; two in September to a radio-relay and television establishment and also to a large power station; and lastly one in October to a well-known electrical engineering firm on Tyneside. Other visits will be arranged for the future and it is hoped that they will prove as enjoyable as those in the past.

The shaping of the programme has not been easy, but with some helpful assistance from the local liaison officer our difficulties are almost solved.

Our first meeting had for its main feature an informal talk on "The Duties, Responsibilities, etc., of an Area Engineer," given jointly by our own Area Engineers, Mr. J. E. Collins and Mr. A. E. Twycross, B.E.M. An interesting discussion followed on various points covering discipline, efficiency, works units, finance, co-operation with other authorities, etc., and all queries were answered simply and yet fully enough to leave no doubts in the mind of the questioners.

Further papers to be given this session will include subjects such as U.A.X. principles, high-voltage grid scheme control, frequency modulation, and mechanical aids in telecommunications practice.

Now that we have got the wheels to turn, it is up to the members to keep them turning and this can best be done by attending the meetings and visits arranged for members' benefit.

G. D. C.

Bishop's Stortford Centre

The Bishop's Stortford Centre of the Associate Section commenced its activities for the year 1954-55 with a visit, on the 1st September, to the National Radio Exhibition at Earls Court. Despite a very hot day a full coachload was mustered and a very enjoyable afternoon and evening were spent at this ever-popular show.

On the 28th September a visit was paid to the Post Office wireless telegraphy transmitting station at Ongar. This was an evening visit and a good number of our members were scheduled to attend, but unfortunately, late in the afternoon, a cable fault developed in the Area which prevented several members making the trip.

In October a member of the plastics industry came along to our meeting place in South Street and gave us what proved to be an extremely interesting and informative talk on modern plastics. The speaker and his assistant manufactured two forms of plastic material at the meeting. Several of us accepted a challenge to break these, but were unsuccessful!

In December a film show of a non-technical nature was held at South Street.

Several of the visits planned did not, for various reasons, materialise, and so it was not until April that the next meeting was held. This was a talk given by Mr. E. A. Mayne, B.Sc., A.M.I.E.E., Telephone Manager, Guildford. His subject was "Telephony in the U.S.A.," a very enlightening talk on the telephone administration of that country.

The following items were arranged for the first half of the 1955/56 session:—

21st November.—A visit by 16 members to the Vauxhall Motor Works, Luton.

6th December.—A talk by Mr. S. J. Edwards, A.M.I.E.E., Telephone Manager, Cambridge, on "The T.M.'s Office and Its Organisation."
J. S. R.

London Centre

During October our Librarian, Mr. F. E. Baker, had to resign due to pressure of work. He had held the post for 2½ years and done an excellent job in supplying members with periodicals; his work is even more meritorious when one considers that for the majority of that time he had no assistance yet managed to maintain the circulation. Mr. Baker may be very pleased with his achievements, as a record number of periodicals were circulated during the 1954/55 session. The London Centre is very unfortunate and sorry to lose Mr. Baker.

The new Librarian, who has been co-opted to the committee, is Mr. S. Challoner; his address is Balham A.T.E., 49 Upper Tooting Road, Tooting, S.W.17, and the telephone number is BALham 1112.

The attendances at Centre meetings are again lower than the organisers would like, and to date the average attendance at 1955/56 meetings is the lowest yet. The subject-matter of the papers, automobile engineering, information theory, radar, rocket propulsion, and American telephone exchanges, was chosen to attract those who wanted a subject not akin to their everyday work, and yet satisfy the regular supporters.

The meetings arranged for the next three months are as follows:—

31st January.—"Colour Television," by Mr. Jesty, of Marconi Research Laboratory.

20th March.—"Applications of Electronics on British Railways," by Mr. D. R. Turner.

11th April.—"Mathematics—a Realistic Approach," by Mr. R. New.

Make a note of these dates, as your support is needed. It is not fair to expect the speakers to give up valuable time to talk to a handful of people, and it is embarrassing for both speaker and organisers.

The London Centre Committee extend their congratulations to Messrs. Froude, Smith and Vaughan for their success in receiving Senior Section Awards for Papers read at Centre meetings, recorded on p. 246 of this Journal.

The L.P. Reg. Section have added further laurels to their achievements with the Papers by Messrs. Froude and Smith, while the Test Section have collected their second award in two years with Mr. Vaughan's Paper.

If any Associate Section member feels that he would like to make the venture into presenting a paper, either at a Local or a Centre meeting, would he please contact P. Sayers on LTK 6932 for further information. This applies particularly to members in the L.T. Reg., whose papers during the last five years total one!
P. S.

Aylesbury (late Chiltern) Centre

Two interesting and popular visits have been made this session, one to G.E.C.'s Telephone Works at Coventry and one to "Air Trainers" local factory.

A full programme of talks has not been possible, but members' interest has been sustained by two film shows, one on motor-car testing and travel, and one on "Bees," with a talk by Mr. J. M. Hurn.

Two outstanding talks (both well attended) were "Planning for the next 5-7 years," by Mr. R. C. Such, our Area Engineer, and "Development of the Telephone," by Mr. C. Hartwell. In November Mr. A. D. V. Knowers, Telephone Manager, gave a talk on "Area Policy."

The programme for 1956 is shaping well, and we hope complete details will be available at the annual general meeting in December, together with particulars of our summer visit, which we hope will include a visit to the factory of Standard Telephones and Cables, Ltd.
H. J. T.

Edinburgh Centre

At the opening meeting of the Centre, Mr. J. Fergusson gave an excellent talk on the "Electrical Side of the Motor Car," and thereby set a high standard for the rest of our meetings this year. The October meeting took the form of a film show, when a grand programme of interesting films was shown by our Centre "movie-expert" Mr. D. Plenderleith. Mr. R. J. Hines, C.R.E., and Mr. H. Stevenson, Area Engineer, were guests of the Centre that evening, and during a break in the programme the C.R.E. presented Mr. J. R. Haggart with an I.P.O.E.E. Certificate of Merit.

Two very successful visits were made during the past month to the B.B.C. Transmitting Station, Westerglen, and to the engineering works of Bruce Peebles, Ltd. Visits are very popular in the Edinburgh Centre, and quite a few equally interesting trips have been arranged for the near future.
J. R. H.

Glasgow and Scotland West Centre

The programme for 1955-56 is now under way and the session promises to be a very successful one.

"Elements of Electronic Switching," by Mr. J. J. Loughlin, A.M.I.E.E., S.E.E., Edinburgh, and "Law and Order," by Detective Superintendent George MacLean, of the Identification Bureau of the City of Glasgow Police, have both taken place and were very well received.

The remainder of the programme is as follows:—

18th November.—"Post Office Finance," by Miss V. Smithies, S.E.O., Edinburgh.

8th December.—"Across Canada by Canadian Pacific."
A colour film.

10th January.—Theatre Night.

20th January.—"Heredity," by Dr. A. W. M. Coombs, Post Office Research Station.

14th February.—"Radio Links," by Mr. T. Moxon, S.E.E., Edinburgh.

16th March.—"Practical TV," by Mr. R. H. Garner, B.Sc., A.M.I.E.E., Principal, School of Engineering, Burnbank.

19th April.—"Plastics," by I.C.I.

The Committee feel that the remainder of the programme still to be delivered will be as interesting and enjoyable as the items now past, and that the mixture of social events, non-technical lectures and technical lectures will result in large attendances and enjoyable evenings.
J. F.

Dundee Centre

The 1955/56 Session commenced with a visit to the S.H.F. Radio Link (television) Station at Craigowl Hill, and two very interesting lectures on Transistors and Photography.

If the remaining items in the programme attain the high standard already set we shall have a most successful session, especially as our membership has risen to approximately 120.
J. O. P.

Staff Changes

Promotions

Name	Region	Date	Name	Region	Date
<i>C.R.E. to Asst. Engineer-in-Chief</i>			<i>Tech. Offr. to Asst. Engr.—continued.</i>		
Warren, A. C.	S.W. Reg. to E.-in-C.O.	1.9.55	George, G.	W.B.C.	12.4.55
<i>Regional Engr. to C.R.E.</i>			Wadsworth, P. H.	W.B.C.	12.4.55
Morrill, A. E.	S.W. Reg.	22.9.55	Hayward, A.	W.B.C.	2.4.55
<i>Asst. Staff Engr. to Staff Engr.</i>			Smith, D. L.	Scot.	14.9.55
Taylor, F. J. D.	E.-in-C.O.	17.10.55	Tolmie, R. G.	Scot.	20.9.55
<i>Snr. Exec. Engr. to Asst. Staff Engr.</i>			Warrington, T. N.	N.W. Reg.	31.10.55
Piggott, J.	E.-in-C.O.	12.9.55	<i>Tech. Offr. to Inspector</i>		
<i>Snr. Exec. Engr. to Principal</i>			Lewington, H. W.	H.C. Reg.	29.12.55
Goldsmith, F. H.	E.-in-C.O. to P.D.	7.11.55	Hedges, R. J. P.	H.C. Reg.	2.3.55
<i>Exec. Engr. to Snr. Exec. Engr.</i>			MacDonald, W. F.	Scot.	1.8.55
Loughlin, J. J.	Scot.	5.8.55	Adams, T.	Scot.	1.8.55
Aucott, A. T.	L.P. Reg. to Mid. Reg.	22.9.55	Wallis, E. A.	Mid. Reg.	15.8.55
Birss, R. R.	N.E. Reg. to Scot.	29.8.55	McHarg, J. T.	Scot.	5.9.55
Froom, R. P.	E.-in-C.O.	5.8.55	Walker, J.	Scot.	19.9.55
Berge, M.	L.T. Reg.	21.6.55	Forster, H.	N.E. Reg.	1.5.55
Bennett, R. O.	E.-in-C.O.	3.8.55	Hirst, K. W.	N.W. Reg.	5.10.55
Carnson, L. B.	L.T. Reg. to N.I.	22.8.55	Keys, P. H.	S.W. Reg.	12.9.55
Gerry, P. R. C.	H.C. Reg.	4.5.55	Bowden, M. A. H.	S.W. Reg.	10.9.55
Hix, K. W.	E.-in-C.O.	2.9.55	Pasco, M. J.	S.W. Reg.	19.9.55
McDowell, D.	E.-in-C.O.	29.8.55	Johnson, W. H.	N.W. Reg.	27.10.55
<i>Asst. Engr. to Exec. Engr.</i>			<i>Tech. I. to Inspector</i>		
Glover, W. A.	S.W. Reg. to L.P. Reg.	18.8.55	Reynolds, V. J.	H.C. Reg.	1.5.55
Long, J. H.	E.-in-C.O. to L.T. Reg.	2.8.55	Holliday, F.	L.P. Reg.	28.5.55
Lowne, H. R. B.	E.-in-C.O.	15.8.55	Adams, G. L.	L.P. Reg.	20.8.55
Farmer, K. C. D.	E.-in-C.O.	5.8.55	Orchard, C. J.	H.C. Reg.	22.7.55
Akester, K. M.	E.-in-C.O.	1.9.55	Day, J.	H.C. Reg.	22.7.55
Crump, S. G.	H.C. Reg.	31.5.55	Shorrocks, H.	N.W. Reg.	5.8.55
Childe, P. F.	N.W. Reg. to E.-in-C.O.	5.9.55	Duncan, D. W.	Scot.	1.8.55
Toomer, R. A.	H.C. Reg.	5.8.55	Evans, B. H. W.	L.T. Reg.	2.7.55
Bird, J. R.	H.C. Reg.	1.8.55	Birchmore, A. L.	L.T. Reg.	11.7.55
<i>Inspector to Asst. Engr.</i>			Musker, H. J.	W.B.C.	15.6.55
Pleasants, L. H.	H.C. Reg.	22.7.55	Williams, D. R.	W.B.C.	6.6.55
Griffiths, H.	W.B.C.	1.4.55	Wood, E. T.	W.B.C.	15.6.55
Thomas, J. L.	W.B.C.	9.5.55	Alderson, W.	W.B.C.	15.6.55
Long, E.	N.E. Reg.	8.8.55	Mills, R. G. L.	W.B.C.	8.6.55
Myers, S.	N.W. Reg.	24.9.55	Henry, W. L.	Scot.	1.8.55
John, G. L.	W.B.C.	1.10.55	Gordon, J. E. M.	Scot.	1.9.55
<i>Tech. Offr. to Asst. Engr.</i>			Ingram, A.	Scot.	1.8.55
Barber, J.	H.C. Reg.	30.6.55	Devlin, F. J.	N.I.	2.6.55
Clarke, W. R.	E.-in-C.O.	8.8.55	George, P. H.	N.E. Reg.	1.5.55
Bond, A. H.	H.C. Reg.	22.7.55	Cooper, C.	N.E. Reg.	1.10.55
Gillett, D. S.	H.C. Reg.	22.7.55	Bowers, C. E.	N.W. Reg.	19.9.55
Henderson, G. G.	Scot.	1.8.55	Coulthard, H. B.	N.W. Reg.	19.9.55
Parsons, S. E.	Mid. Reg.	15.8.55	Spiers, B. N.	N.W. Reg.	29.9.55
Beastall, W. A.	Mid. Reg.	22.8.55	Moggeridge, A.	L.T. Reg.	23.10.55
Peake, W.	Mid. Reg.	23.5.55	Williams, C. H.	W.B.C.	22.2.55
Hull, A. E.	Mid. Reg.	1.6.55	Bayley, H. R.	W.B.C.	4.7.55
Smith, P. E.	Mid. Reg.	22.5.55	Lloyd, C.	W.B.C.	9.7.55
Evans, M. P. J.	E.-in-C.O.	13.8.55	Prichard, W.	W.B.C.	8.8.55
Dungworth, E.	N.E. Reg.	19.9.55	<i>Snr. Sc. Offr. (Open Competition)</i>		
Hill, J. D.	N.E. Reg.	28.3.55	Ellis, A. S.	E.-in-C.O.	17.8.55
Fish, H. W.	N.E. Reg.	1.5.55	<i>Sc. Offr. to Snr. Sc. Offr.</i>		
Sefton, R. C.	N.E. Reg.	19.9.55	Harrison, J. C.	E.-in-C.O.	19.7.55
Scrivener, L. W.	E.T.E.	18.6.55	Hastie, R. A.	E.-in-C.O.	19.7.55
Sheldrake, R. P. G.	E.T.E.	18.6.55	<i>Exptl. Offr. to Snr. Exptl. Offr.</i>		
Crowther, J. L.	E.T.E.	18.6.55	Child, M. R.	E.-in-C.O.	17.8.55
Faulkner, H. N.	E.T.E.	18.6.55	<i>Exptl. Offr. (Open Competition)</i>		
Parrish, T. R.	W.B.C.	2.3.55	Jordan, K. A.	E.-in-C.O.	26.9.55
Mathias, H.	W.B.C.	10.6.55	Trafford, D. J.	E.-in-C.O.	7.10.55
Sutherland, N. R.	Scot.	4.9.55	<i>Asst. Exptl. Offr. to Exptl. Offr.</i>		
Holdway, A.	Mid. Reg.	1.10.55	Elliott, C. R.	E.-in-C.O.	19.7.55
Hewitt, H. S.	L.T. Reg.	12.4.55	<i>Asst. Exptl. Offr. (Open Competition)</i>		
Wilson, J.	L.T. Reg.	24.2.55	Hilton, V. M. (Miss)	E.-in-C.O.	7.10.55
Dell, A. G.	L.T. Reg.	25.4.55	<i>Asst. Exptl. Offr. (Limited Competition)</i>		
Jackson, T. A.	W.B.C.	9.5.55	Parker, A. E.	E.-in-C.O.	16.6.55
Milne, J. L.	Scot.	8.8.55			
Irvine, W. F.	Scot.	13.8.55			
Bowley, J. L.	Mid. Reg.	30.9.55			

Retirements and Resignations

Name	Region	Date	Name	Region	Date
<i>Asst. Engineer-in-Chief</i>			<i>Asst. Engr.—continued.</i>		
Reading, J.	E.-in-C.O. (<i>Resigned</i>)	31.8.55	Barton, A. L.	N.E. Reg.	30.8.55
<i>Asst. Staff Engr.</i>			Evans, W. H.	W.B.C.	30.9.55
Gill, O. W.	E.-in-C.O.	11.9.55	Gooch, J. V. L.	L.T. Reg.	1.10.55
<i>Snr. Exec. Engr.</i>			Easthill, C. F.	L.T. Reg.	3.10.55
Hedges, E. W.	E.T.E.	31.8.55	Collins, W. J.	L.T. Reg.	29.10.55
Phillips, S. A.	E.-in-C.O. (<i>Resigned</i>)	31.8.55	Mitchell, H. B.	L.T. Reg.	31.10.55
Parker, J. D.	On loan to Control Com- mission in Germany (<i>Resigned</i>)	31.8.55	Loader, S. F.	L.T. Reg.	31.10.55
<i>Exec. Engr.</i>			Lindsay, H. L.	Scot.	31.10.55
Brandrum, W. H.	L.P. Reg.	17.8.55	Marsland, J. P.	N.E. Reg.	4.11.55
Diggie, A.	N.E. Reg.	31.8.55	Blackhall, W. A. C.	E.-in-C.O.	11.11.55
Smallwood, W. K.	E.T.E.	30.9.55	<i>Inspector</i>		
Davidson, W. B.	Scot.	12.10.55	Watson, H.	N.E. Reg.	9.8.55
Tudor-Owen, R. L. T.	E.-in-C.O. (<i>Resigned</i>)	21.10.55	Howitt, J. T.	Mid. Reg.	24.8.55
<i>Asst. Engr.</i>			Fraser, J.	Scot.	31.8.55
Barnes, H.	S.W. Reg.	12.8.55	Joiner, W. J.	Mid. Reg.	30.9.55
Wrenn, H. G.	Mid. Reg.	15.8.55	Irving, E.	N.W. Reg.	30.9.55
Forty, S. C.	H.C. Reg.	31.8.55	Adams, W.	L.T. Reg.	30.9.55
Appleby, W. J. H.	E.-in-C.O. (<i>Resigned</i>)	13.8.55	Briscoe, H. R.	N.E. Reg.	3.10.55
Taylor, E. R.	H.C. Reg. (<i>Resigned</i>)	26.8.55	Storey, H. W.	H.C. Reg.	7.10.55
Griffiths, G. G.	Mid. Reg. (<i>Resigned</i>)	31.8.55	White, A. W.	H.C. Reg.	8.10.55
Williams, H.	L.T. Reg.	4.8.55	Campbell, T. M.	Scot.	31.10.55
Wright, C. W.	L.T. Reg.	19.8.55	<i>Exptl. Offr.</i>		
Millyard, R.	E.T.E.	23.8.55	Butterworth, J.	E.-in-C.O. (<i>Resigned</i>)	31.10.55
Utting, A. P.	E.-in-C.O.	16.9.55	<i>Asst. Exptl. Offr.</i>		
Colvin, M.	Scot.	24.9.55	Rogers, R. A.	E.-in-C.O. (<i>Resigned</i>)	26.9.55
Hall, H.	Mid. Reg.	30.9.55	<i>Asst. (Sc.)</i>		
Bell, T. H.	L.T. Reg.	30.9.55	Charnock, J. D.	E.-in-C.O. (<i>Resigned</i>)	6.8.55
Cleary, E. J.	N.W. Reg.	2.10.55	Clark, I. D.	E.-in-C.O. (<i>Resigned</i>)	14.8.55
Rawlings, J. E.	N.E. Reg.	3.10.55	<i>Temp. Asst. (Sc.)</i>		
Spencer, W. C.	N.W. Reg.	3.10.55	Holland, A. R.	E.-in-C.O. (<i>Resigned</i>)	13.7.55
Barker, C. W.	E.-in-C.O. (<i>Resigned</i>)	30.9.55	McKenzie, M. (Miss)	E.-in-C.O. (<i>Resigned</i>)	30.9.55

Transfers

Name	Region	Date	Name	Region	Date
<i>Snr. Exec. Engr.</i>			<i>M.T.O. III</i>		
Hamilton, R. N.	Loan to B.A.O.R. to E.-in-C.O.	20.8.55	White, G.	E.-in-C.O. to N.I.	1.8.55
French, E. J.	Scot. to S.W. Reg.	29.8.55	<i>Asst. Engr.</i>		
Dixon, J.	Scot. to N.W. Reg.	12.9.55	Bird, S. G.	E.-in-C.O. to Min. of Supply	29.8.55
German, A. G.	E.-in-C.O. to E.T.E.	1.11.55	Prout, A. G.	E.-in-C.O. to Iran (approved employment)	15.8.55
<i>Exec. Engr.</i>			Waters, J. I.	H.C. Reg. to Iran (approved employment)	14.8.55
Kitchenn, R. G.	E.-in-C.O. to Australia	27.3.51	Robinson, J. J.	E.-in-C.O. to L.T. Reg.	4.9.55
Meredith, T. E.	E.-in-C.O. to W.B.C.	23.8.55	Dellar, A. S.	L.T. Reg. to H.C. Reg.	8.8.55
Crank, F. G.	E.-in-C.O. to Colombia (approved employment)	1.9.55	Crowley, S. E.	E.-in-C.O. to Admiralty	20.8.55
Gregory, M. S. E.	E.-in-C.O. to Min. of Supply	1.9.55	Meed, R. H.	L.T. Reg. to S.W. Reg.	26.9.55
Blakey, R.	E.-in-C.O. to Iran (approved employment)	10.9.55	Wallace, A.	E.-in-C.O. to H.C. Reg.	2.10.55
<i>M.T.O. II</i>			Fuller, J. A.	E.-in-C.O. to H.C. Reg.	30.10.55
Finney, C. W. M. S.	E.-in-C.O. to Min. of Trans- port and C.A.	3.8.55			

Deaths

Name	Region	Date	Name	Region	Date
<i>Asst. Engr.</i>			<i>Inspector</i>		
Cork, H. E.	L.T. Reg.	21.8.55	Dunleavy, P. L.	Mid. Reg.	13.8.55
Bowers, R.	Mid. Reg.	24.8.55	Toovey, E. A. W.	L.T. Reg.	11.9.55
Brown, J.	Scot.	29.9.55			
Dickman, R. W.	Mid. Reg.	29.9.55			
Hiseman, A. E.	L.T. Reg.	30.9.55			

Post Office Electrical Engineers' Journal

Volume 48, April 1955—January 1956

INDEX

	PAGE NO.		PAGE NO.
A		D (continued)	
Accelerated Life Tests in the Investigation of Mechanical Performance	198	Dover-Deal Experimental Cable, The Part 1.—Description of Cable, Factory Tests, Installation and Jointing	224
Aerial-Systems, Short-Wave Directional	29	Drum Trailer, A New Cable-	202
Aids for External Work, Portable Generating Set and Low-voltage Electrical	143	E	
Amplifier, A Negative Impedance Converter for use as a Two-Terminal	97	Electronic Digital Computer, "Mosaic"—An	114, 137, 212
Anti-Side-Tone Telephone Circuits, Some Principles of	208	Electronic Programme Clock, An	12
Area Planning and General Purpose Vehicle, An	112	Equipment for Measurement of Inter-Channel Crosstalk and Noise on Broad-Band Multi-Channel Telephone Systems	127
Associate Section Notes	61, 120, 186, 254	Experiments in Cleaning Exchange Equipment by Blowing	34
Automatic Sub-Centres for the New Telex Service	17	F	
B		Field Trial of Pressurised Cable System	7
Bassett, H. G. The Transistor (Part 6)	47	Fielding, H. Protection of Telecommunication Lines from Induced Voltages by the Use of Gas Discharge Tubes	76
Belton, R. C. A New Type of Telegraph Power Plant	71	Filter, A Ten-Kilowatt Low-Pass	94
Blowing, Experiments in Cleaning Exchange Equipment by	34	Forster, A. E. T., and C. A. R. Turbin. Automatic Sub-Centres for the New Telex Service	17
Book Reviews .. 11, 21, 25, 35, 42, 70, 86, 101, 113, 153, 158, 211, 228, 238, 239, 245		Forth Bridge, Provision of New Trunk Cables Across the	65
British Post Office Speaking Clock, Mark II, The	154	Forty, A. J., and F. A. Milne. The British Post Office Speaking Clock, Mark II (Part I)	154
Part 1.—Design and Performance	154	Frequency Generating Equipment for Large Coaxial and Carrier Stations, Carrier	148, 216
Part 2.—Layout, Manufacture and Packing for Export	229	Frequency Modulator for Broad-Band Radio Relay Systems, A	108
Broad, E. R., and E. J. P. May. A Ten-Kilowatt Low-Pass Filter	94	Frequency Standardisation Abroad, Post Office Quartz Oscillators for Use in Time and	26
C		G	
Cable, Completion of the First Transatlantic Telephone	230	Gammon, P. W. J., and W. Dolman. Modernisation of Radio and Radar Equipment in H.M. Telegraph Ships	204
Cable-Drum Trailer, A New	202	Garbutt, A. W. N. A Dial Pulse Generator	84
Cable System, Field Trial of Pressurised	7	Gas Discharge Tubes, Protection of Telecommunication Lines from Induced Voltages by the Use of	76
Cable, The Dover-Deal Experimental	224	Generating Set and Low-voltage Electrical Aids for External Work, Portable	143
Cable, Transatlantic Telephone—Inaugural Ceremonies and the First Laying Operation	174	Generator, A Dial Pulse	84
Cables across the Forth Bridge, Provision of New Trunk	65	Gerrard, J. Provision of New Trunk Cables Across the Forth Bridge	65
Call Office Unit, A Mobile	172	Gould-Bacon, F. C., and R. F. Purves. Developments in Exchange Ringing Equipment	150
Carrier Frequency Generating Equipment for Large Coaxial and Carrier Stations	148	Granger, S. H. The New Independent-Television Network	191
Part 1.—General Features, Rack Equipment and Changeover Circuits	148	Grant, C. G., and F. V. Partridge. London Trunk Kingsway Exchange	87
Part 2.—The 124 kc/s Master Oscillator, the Frequency Divider and the Frequency-Comparison and Alarm Apparatus	216	Greening, F. C. G., and E. R. Collings. A Mobile Call Office Unit	172
Cartridge-Fired Hammer Guns	164	Guns, Cartridge-Fired Hammer	164
C.C.I.R. Study Group IX, Geneva, September, 1954, Meeting of	53	H	
C.C.I.R. Study Groups I and XI, Brussels, March/April, 1955, Meetings of	142	Halsey, R. J. Completion of the First Transatlantic Telephone Cable	230
Cleaning Exchange Equipment by Blowing, Experiments in Clock, An Electronic Programme	12	Halsey, R. J. Transatlantic Telephone Cable—Inaugural Ceremonies and the First Laying Operation	174
Clock, Mark II, The British Post Office Speaking	154, 229	Harris, E. T. C., and S. Munday. Carrier Frequency Generating Equipment for Large Coaxial and Carrier Stations	148, 216
Cobbe, D. W. R. Noise Interference from External Sources	39	Hayes, H. C. S. The Dover-Deal Experimental Cable (Part I)	224
Collings, E. R., and F. C. G. Greening. A Mobile Call Office Unit	172	Hitchin, E. J. T., L. A. Missen and R. A. Snook. Thanet Cordless Switchboard	102
Colour and Colour Television, Light	22	Hubbard, E. W. C., and M. Mitchell. Accelerated Life Tests in the Investigation of Mechanical Performance	198
Completion of the First Transatlantic Telephone Cable	230	Hysteresis Loops, Magnetic Materials with Rectangular	1
Computer, "Mosaic"—An Electronic Digital	114, 137, 212	I	
Contact Resistance under Dynamic Conditions, A Method of Recording	240	Impedance Dialling	110
Coombs, A. W. M. "Mosaic"—An Electronic Digital Computer	114, 137, 212	Independent-Television Network, The New	191
Cross, P. C., and A. W. Rance. Experiments in Cleaning Exchange Equipment by Blowing	34	Institution of Post Office Electrical Engineers	56, 117, 177, 246
Crosstalk and Noise on Broad-Band Multi-Channel Telephone Systems, Equipment for Measurement of Inter-Channel	127	Instrument for the Measurement and Display of V.H.F. Network Characteristics, An	81
Crystals, The Laboratory Production of Large Water-Soluble	219	Interference from External Sources, Noise	39
D		Isle of Wight Television Link, Stage One, The London-	36
Developments in Exchange Ringing Equipment	159		
Dial Pulse Generator, A	84		
Dialling, Impedance	110		
Dobbie, A. K. An Electronic Programme Clock	12		
Dolman, W., and P. W. J. Gammon. Modernisation of Radio and Radar Equipment in H.M. Telegraph Ships	204		
Donovan, J. G., and R. Tharby. Portable Generating Set and Low-voltage Electrical Aids for External Work	143		

K	PAGE NO.
Keep, J. F. Field Trial of Pressurised Cable System ..	7
Kilvington, T. The London-Isle of Wight Television Link, Stage One	36
King, F. A. A New Routiner for Outgoing Trunk and Junction Circuits	14
Kingsway Exchange, London Trunk	87

L	
Laboratory Production of Large Water-Soluble Crystals, The	219
Laver, F. J. M. Light, Colour and Colour Television ..	22
Lawrence, C., and D. S. Longmore. A Transportable Artificial- Traffic Equipment	133
Life Tests in the Investigation of Mechanical Performance, Accelerated	198
Light, Colour and Colour Television	
Part 2.—Human Vision and Colour Television ..	22
London-Isle of Wight Television Link, Stage One, The ..	36
London Trunk Kingsway Exchange	87
Longmore, D. S., and C. Lawrence. A Transportable Artificial- Traffic Equipment	133

M	
McClements, J. S. Post Office Quartz Oscillators for Use in Time and Frequency Standardisation Abroad	26
Magnetic Materials with Rectangular Hysteresis Loops ..	1
Materials with Rectangular Hysteresis Loops, Magnetic ..	1
May, E. J. P., and E. R. Broad. A Ten-Kilowatt Low-Pass Filter	94
Measurement and Display of V.H.F. Network Characteristics, An Instrument for the	81
Measurement of Inter-Channel Crosstalk and Noise on Broad-Band Multi-Channel Telephone Systems, Equip- ment for	127
Meeting of C.C.I.R. Study Group IX, Geneva, September, 1954	53
Meetings of C.C.I.R. Study Groups I and XI, Brussels, March/ April 1955	142
Method of Recording Contact Resistance under Dynamic Conditions, A	240
Milne, F. A., and A. J. Forty. The British Post Office Speaking Clock, Mark II (Part 1)	154
Missen, L. A., R. A. Snook, and E. J. T. Hitchin. Thanet Cordless Switchboard	102
Mitchell, M., and E. W. C. Hubbard. Accelerated Life Tests in the Investigation of Mechanical Performance	198
Mobile Call Office Unit, A	172
Modernisation of Radio and Radar Equipment in H.M. Telegraph Ships	204
Modulator for Broad-Band Radio Relay Systems, A Frequency	108
Moffatt, J. J. A New Cable-Drum Trailer	202
Morris, D. W., W. G. Shaddick and E. W. Thurlow. Short- Wave Directional Aerial-Systems	29
"Mosaic"—An Electronic Digital Computer	
Part 1.—The Store and Arithmetic Units	114
Part 2.—The Control and Input-Output Units	137
Part 3(a).—The Art of Programming	212
Munday, S., and E. T. C. Harris. Carrier Frequency Generat- ing Equipment for Large Coaxial and Carrier Stations	148, 216

N	
Negative Impedance Converter for Use as a Two-Terminal Amplifier, A	97
New Cable-Drum Trailer, A	202
New Independent-Television Network	191
New Routiner for Outgoing Trunk and Junction Circuits, A	14
New Type of Telegraph Power Plant, A	71
Noise Interference from External Sources	39
Noise on Broad-Band Multi-Channel Telephone Systems, Equipment for Measurement of Inter-Channel Crosstalk and	127
Notes and Comments	55, 117, 177, 247
Notes, Associate Section	61, 120, 186, 254
Notes, Regional	57, 118, 170, 249

O	
Opening of New Rugby Radio Station	170
Oscillators for Use in Time and Frequency Standardisation Abroad, Post Office Quartz	26
Outside Broadcasts, The Provision of Circuits for Television	166, 234

P	PAGE NO.
Parkin, B. G., Magnetic Materials with Rectangular Hysteresis Loops	1
Partridge, F. V., and C. G. Grant. London Trunk Kingsway Exchange	87
Polio Sufferer, Telephone Service for a	38
Portable Generating Set and Low-voltage Electrical Aids for External Work	143
Post Office Quartz Oscillators for Use in Time and Frequency Standardisation Abroad	26
Power Plant, A New Type of Telegraph	71
Pressurised Cable System, Field Trial of	7
Production of Large Water-Soluble Crystals, The Laboratory	219
Protection of Telecommunication Lines from Induced Voltages by the Use of Gas Discharge Tubes	76
Provision of Circuits for Television Outside Broadcasts, The Part 1.—Video Transmission on Telephone Line Plant	166
Part 2.—Injection of Vision Signals at Intermediate Points on Main Cable Links	234
Provision of New Trunk Cables Across the Forth Bridge ..	65
Pulse Generator, A Dial	84
Purves, R. F., and F. C. Gould-Bacon. Developments in Exchange Ringing Equipment	159

R	
Radio and Radar Equipment in H.M. Telegraph Ships, Modernisation of	204
Rance, A. W., and P. C. Cross. Experiments in Cleaning Exchange Equipment by Blowing	34
Ravenscroft, I. A., and R. W. White. A Frequency Modulator for Broad-Band Radio Relay Systems	108
Regional Notes	57, 118, 179, 249
Resistance under Dynamic Conditions, A Method of Recording Contact	240
Ringing Equipment, Developments in Exchange	159
Roberts, F. F., and J. R. Tillman. The Transistor (Part 5)	43
Routiner for Outgoing Trunk and Junction Circuits, A New	14
Rugby Radio Station, Opening of New	170

S	
Sewter, J. B., and M. B. Williams. The Provision of Circuits for Television Outside Broadcasts	166, 234
Shaddick, W. G., E. W. Thurlow and D. W. Morris. Short- Wave Directional Aerial-Systems. (Part 2.)	29
Sheppard, S. H., and T. F. A. Urben. A Method of Recording Contact Resistance under Dynamic Conditions	240
Ships, Modernisation of Radio and Radar Equipment in H.M. Telegraph	204
Short-Wave Directional Aerial-Systems	
Part 2.—Further Types of Aerial; Ground Effects; Impedance Matching	29
Slater, G. H. An Area Planning and General Purpose Vehicle	112
Smith, E. E. M. Cartridge-Fired Hammer Guns	164
Smith, R. L. The British Post Office Speaking Clock, Mark II (Part 2)	229
Snook, R. A., E. J. T. Hitchin and L. A. Missen. Thanet Cordless Switchboard	102
Some Principles of Anti-Side-Tone Telephone Circuits ..	208
Spencer, H. J. C. Some Principles of Anti-Side-Tone Telephone Circuits	208
Staff Changes	62, 123, 187, 256
Sub-Centres for the New Telex Service, Automatic	17
Switchboard, Thanet Cordless	102

T	
Taylor, E. A. The Laboratory Production of Large Water- Soluble Crystals	219
Telephone Circuits, Some Principles of Anti-Side-Tone ..	208
Telephone Service for a Polio Sufferer	38
Television, Light, Colour and Colour	22
Television Link, Stage One, The London-Isle of Wight ..	36
Television Network, The New Independent-	191
Television Outside Broadcasts, The Provision of Circuits for	166, 000
Telex Service, Automatic Sub-Centres for the New	17
Ten-Kilowatt Low-Pass Filter, A	94
Thanet Cordless Switchboard	102
Tharby, R., and J. G. Donovan. Portable Generating Set and Low-voltage Electrical Aids for External Work	143
Thurlow, E. W., D. W. Morris and W. G. Shaddick. Short- Wave Directional Aerial-Systems. (Part 2.)	29
Tillman, J. R. A Negative Impedance Converter for use as a Two-Terminal Amplifier	97
Tillman, J. R., and F. F. Roberts. The Transistor. (Part 5.)	43
Time and Frequency Standardisation Abroad, Post Office Quartz Oscillators for Use in	26

T (continued)	PAGE NO.	V	PAGE NO.
Traffic Equipment, A Transportable Artificial-Trailer, A New Cable-Drum	133	Vehicle, An Area Planning and General Purpose	112
Transatlantic Telephone Cable, Completion of the First	202	V.H.F. Network Characteristics, An Instrument for the Measurement and Display of	81
Transatlantic Telephone Cable—Inaugural Ceremonies and the First Laying Operation	174	W	
Transistor, The		White, R. W., and I. A. Ravenscroft. A Frequency Modulator for Broad-Band Radio Relay Systems	108
Part 5.—Properties and Limitations	43	White, R. W., and J. S. Whyte. Equipment for Measurement of Inter-Channel Crosstalk and Noise on Broad-Band Multi-Channel Telephone Systems	127
Part 6.—Applications	47	Whyte, J. S. An Instrument for the Measurement and Display of V.H.F. Network Characteristics	81
Transportable Artificial-Traffic Equipment, A	133	Whyte, J. S., and R. W. White. Equipment for Measurement of Inter-Channel Crosstalk and Noise on Broad-Band Multi-Channel Telephone Systems	127
Trunk Kingsway Exchange, London	87	Williams, M. B., and J. B. Sewter. The Provision of Circuits for Television Outside Broadcasts	166, 234
Turbin, C. A. R., and A. E. T. Forster. Automatic Sub-Centres for the New Telex Service	17	Wroe, H. N. Impedance Dialling	110
U			
Urban, T. F. A., and S. H. Sheppard. A Method of Recording Contact Resistance under Dynamic Conditions	240		

Additions to the Library—continued from p. 248.

- 2297 *How to Lie with Statistics*. D. Huff (Brit. 1955).
A normal manual of self-defence against statisticians.
- 2298 *Atomic Energy Research at Harwell*. (Brit. 1955).
Covers the period from 1951 to date, and some of the work done earlier.
- 2299 *The Practice of O & M*. H.M. Treasury (Brit. 1954).
Designed as a training manual for civil servants engaged on organisation and methods work.
- 2300 *Transistors and Other Crystal Valves*. T. R. Scott (Brit. 1955).
Gives a clear picture of the general stage of development at the present time; aimed at the user rather than the engineer concerned with developing or designing them.
- 2301 *Introduction to Nuclear Engineering*. R. L. Murray (Amer. 1955).
Intended as an introduction to the new developments in atomic energy with special reference to the engineering problems involved.
- 2302 *Technical Publications: their Purpose, Preparation and Production*. C. Baker (Brit. 1955).
A guide to the writing of technical information.
- 2303 *Magnetic Materials in the Electrical Industry*. P. R. Bardell (Brit. 1955).
Seeks to bridge the gap between an academic study of the properties of magnetic materials and the limited treatment of the subject possible in most textbooks for engineers.
- 2304 *Introduction to U.H.F. Circuits and Components*. M. S. Kiver (Amer. 1955).
Presents the concepts of ultra-high-frequency circuits as logical outgrowths of the more-familiar low-frequency equipment.
- 2305 *Applied Electronics*. T. S. Gray (Amer. 1954).
A revised presentation of the subject by the staff of the Department of Electrical Engineers at the Massachusetts Institute of Technology.
- 2306 *Questions and Answers on Automobile Engines*. D. J. Smith (Brit. 1955).
Covers the operation and maintenance of all types of automobile engines.
- 2307 *The Atom*. G. Thomson (Brit. 1955).
An up-to-date account aimed at the non-specialist.
- 2308 *Joint Consultation Over 30 Years*. C. G. Renold (Brit. 1950).
A personal record of the evolution of the machinery of joint consultation in one industrial company.
- 2309 *Radiant Heating, including Cooling and Heat-Pump Applications*. R. W. Shoemaker (Amer. 1954).
Explains and clarifies the general subject of radiant heating and cooling as applying to present-day building.
- 2310 *Automotive Chassis and Body Construction, Operation, and Maintenance*. W. H. Crouse (Amer. 1955).
A detailed and comprehensive exposition of the subject.

BOARD OF EDITORS

- D. A. BARRON, M.Sc., M.I.E.E., Chairman.
W. WEST, O.B.E., B.A., M.I.E.E.
L. F. SCANTLEBURY, Whit.Sch., A.C.G.I., D.I.C., M.I.E.E.
H. G. BEER, Whit.Sch., A.C.G.I.
C. E. CALVELEY, O.B.E., E.R.D., B.Sc.(Eng.), M.I.E.E.
A. F. STOLLARD.
A. E. BAVIN A.M.I.E.E.
W. A. HUMPHRIES, T.D., A.M.I.E.E., Managing Editor.
J. H. BROADHURST, A.M.I.E.E.
E. DAVIS, A.M.I.E.E. } Assistant Editors.
A. J. HUTCHISON, Secretary-Treasurer.

Copyright

The entire contents of this JOURNAL are covered by general copyright, and special permission is necessary for reprinting long extracts, but Editors are welcome to use not more than one-third of any article, provided credit is given at the beginning or end thus: "From the *Post Office Electrical Engineers' Journal*."

The Board of Editors is not responsible for the statements made or the opinions expressed in any of the articles in this JOURNAL, unless such statement is made specifically by the Board.

Communications

All communications should be addressed to the Managing Editor, *P.O.E.E. Journal*, Engineer-in-Chief's Office, Alder House, Aldersgate Street, London, E.C.1. Telephone: HEADquarters 1234. Remittances should be made payable to "*The P.O.E.E. Journal*" and should be crossed "& Co."

Binding Cases

Cases for binding are available, and may be obtained from the Local Agents for 3s. Subscribers can have their copies of volumes bound, at a cost of 10s. 6d., by sending the complete set of parts to the Local Agents or to the *P.O.E.E. Journal*, Engineer-in-Chief's Office, Alder House, Aldersgate Street, London, E.C.1. Orders for binding for Vols. 1-19 should indicate whether the original binding case with black lettering, or the later pattern with gold, is required. Cases with gold lettering are the only type stocked from Vol. 20 onwards.

Back Numbers

The price of the JOURNAL, which is published quarterly, is 2s. 6d. (2s. 9d. post free) per copy, or 11s. per annum, post free. Back numbers can be supplied, subject to availability of stocks, at 2s. 6d. each (2s. 9d. post free). Orders for back numbers may be sent to the *P.O.E.E. Journal*, Engineer-in-Chief's Office, Alder House, Aldersgate Street, London, E.C.1, or to the Publishers.

Employees of the British Post Office can obtain the *Journal* through Local Agents at the reduced price of 2s. per copy.

Advertisements

All communications relating to space reservations should be addressed to the Advertisement Editor, *P.O.E.E. Journal*, Alder House, Aldersgate Street, London, E.C.1. Communications regarding advertisement copy, proofs, etc., should be addressed to the Publishers, Messrs. Birch & Whittington (Prop. Dorling & Co. [Epsom] Ltd.), 49 Upper High Street, Epsom, Surrey.

INDEX TO ADVERTISERS

	PAGE
Adcola Products, Ltd.	iii
Airmec, Ltd.	xxxii
Alton Battery Co., Ltd., The	iv
Austinlite, Ltd.	xxvi
Automatic Coil Winder & Electrical Equipment Co., Ltd.	xxxii
Automatic Telephone & Electric Co., Ltd.	xii-xiii, xxviii-xxix
Bennett College, The	xxxvii
British Electric Resistance Co., Ltd., The	xxvii
British Institute of Engineering Technology	ii
British Insulated Callender's Cables, Ltd.	v
Crown Agents for the Colonies	iii
Edison Swan Electric Co., Ltd., The	xxxviii
Ericsson Telephones, Ltd.	viii
General Electric Co., Ltd., Thex-xi, xviii-xix
Gibbins, Richard C., & Co., Ltd.	xxx
Great Northern Telegraph Co., Ltd.	xxv
Hackbridge Cable Co., Ltd.	xxxv
Hivac, Ltd.	xxxiii
Marconi's Wireless Telegraph Co., Ltd.	xxii
Marconi Instruments	xxiv
Muirhead & Co., Ltd.	xxxviii
Mullard, Ltd.	xxiii
Painton of Northampton	xxi
Pirelli-General Cable Works, Ltd.	xxxv
Pitman, Sir Isaac, & Sons, Ltd.	ii
Pye, Ltd.	xxxiv, xxxvi
Redifon, Ltd.	ii
Siemens Brothers & Co., Ltd.xiv-xv
Siemens Electric Lamps and Supplies, Ltd.	xx
Skillman, T. S., & Co., Ltd.	xvi-xvii
Smith, Frederick, & Co.	xxxvii
Standard Telephones & Cables, Ltd.	vi-vii
Sullivan, H. W., Ltd.	xxxii
Telephone Manufacturing Co., Ltd.	xxxii
Tungstone Products, Ltd.	ix
Turner, Ernest	xxxvii
Vickers, Ltd.	xxvii
Westinghouse Brake & Signal Co., Ltd.	xxxiii
Winn & Coales, Ltd.	xxvii

SENIOR INSTRUCTOR required for the **POST & TELECOMMUNICATIONS DEPT., GOLD COAST LOCAL CIVIL SERVICE** for two tours of 18 to 24 months in the first instance. Consolidated salary scale £1,330 rising to £1,680 a year. Gratuity at the rate of £150 a year. Outfit allowance. Liberal leave on full salary. Free passages. Candidates must have sound general knowledge of overhead and underground distribution, subscribers installations, manual and automatic telephone exchanges, carrier systems and teleprinters and have practical experience in at least two of these subjects. Write to the Crown Agents, 4 Millbank, London, S.W.1. State age, name in block letters, full qualifications and experience and quote M2C/41190/PAA.

**SOLDERING INSTRUMENTS
and ALLIED EQUIPMENT by**



TRADITIONAL BRITISH QUALITY

British, U.S.A., Canadian & Foreign Pats.
Registered Designs, etc.

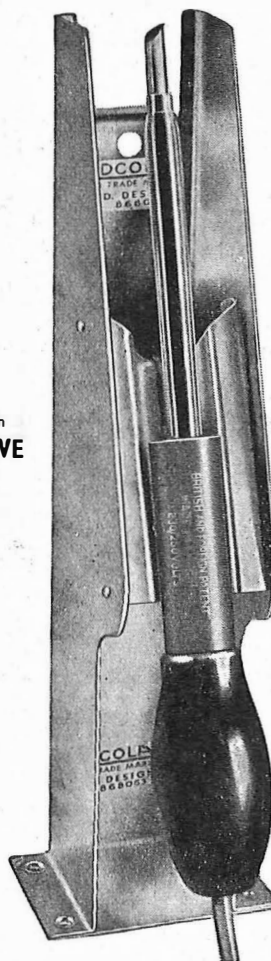

Reg. Design
**PROTECTIVE
SHIELD**
List 68

$\frac{3}{16}$ " Dia.
**DETACHABLE
BIT
INSTRUMENT**
List 64
As illustrated

**SUPPLIED FOR ALL VOLTAGES.
DESIGNED FOR FACTORY BENCH LINE
ASSEMBLY RADIO, TV, DEAF AID, ETC.**

.....Write for Catalogues.....

HEAD OFFICE, SERVICE AND SALES

ADCOLA PRODUCTS LTD
GAUDEN RD., CLAPHAM HIGH ST., LONDON, S.W.4

Phone: MACaulay 3101, 4272



Farmers sometimes grumble, it's said, about quite a number of things.

But you never heard a farmer say 'Trouble with the land, is work-shy men'. You never will—while his men are countrymen. Nobody stands at the countryman's elbow to see that he sticks to the job. Nobody needs remind him that this job or that will call for patience and skill. Nobody had to persuade him to welcome the Machine. All he has said of each new box-of-tricks is 'show me how to work it'. Alton, where Alton batteries are made, is a country town where men are countrymen. Men who haven't yet learnt to believe that what's near enough right is well enough done. Men who are happy to marry the old hand skills to the use of modern machines. Men whose personal standards of workmanship have helped to build a world-wide reputation for Alton Batteries.

ALTON *Batteries of Merit*

Alton stationary batteries: 10 to 15,000 ah. Also in regular production, renewal plates for all makes of battery, British and Continental.

THE ALTON BATTERY COMPANY LIMITED, ALTON, HANTS · Telephone : ALTON 2267 and 2268 · Telegrams : BATTERY, ALTON

A.30

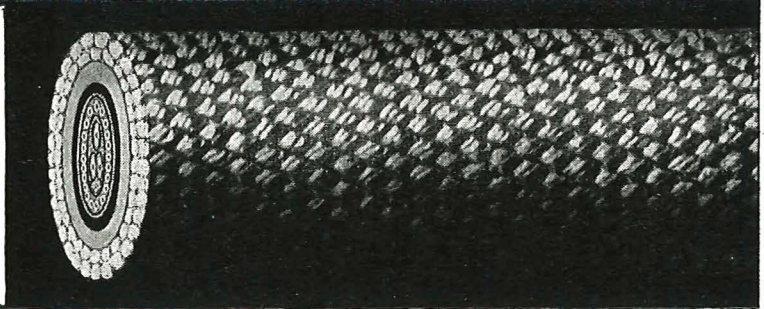
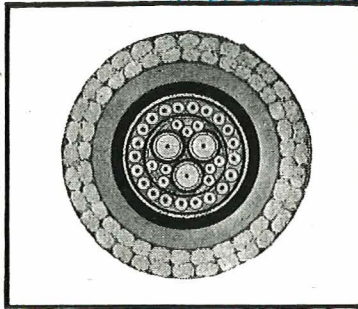

This cable carries

BICC Combined Camera Cable and Lifting Rope for underwater use.

This special multicore T/V camera cable is also used as a rope. It contains all the necessary electrical circuits and supports the full weight of the underwater T/V Camera by means of an overall hemp loom braid. It was designed and manufactured by BICC to meet the requirements of Messrs. Pye Ltd.

During recent trials the camera was repeatedly lowered and operated by this cable. Depths of 83 fathoms were reached and clear pictures obtained. Throughout the trials the cable was subjected to many severe tests. ***ALL CIRCUITS REMAINED INTACT.**

BICC ARE ALWAYS PREPARED TO DESIGN AND MANUFACTURE CABLES TO MEET SPECIAL REQUIREMENTS.

weight

** It withstood a 2½ cwt. shock drop of 20 ft. out of water ; towed the camera at speeds up to 12 knots ; raised and lowered the camera at 250 ft. per minute over narrow diameter pulleys and capstan.*

Subsequent examination proved the cable and coupling to be completely waterproof, resistant to twisting and electrically intact.

BICC T/V CAMERA CABLES

BRITISH INSULATED CALLENDER'S CABLES LIMITED 21 Bloomsbury Street · LONDON · WC1

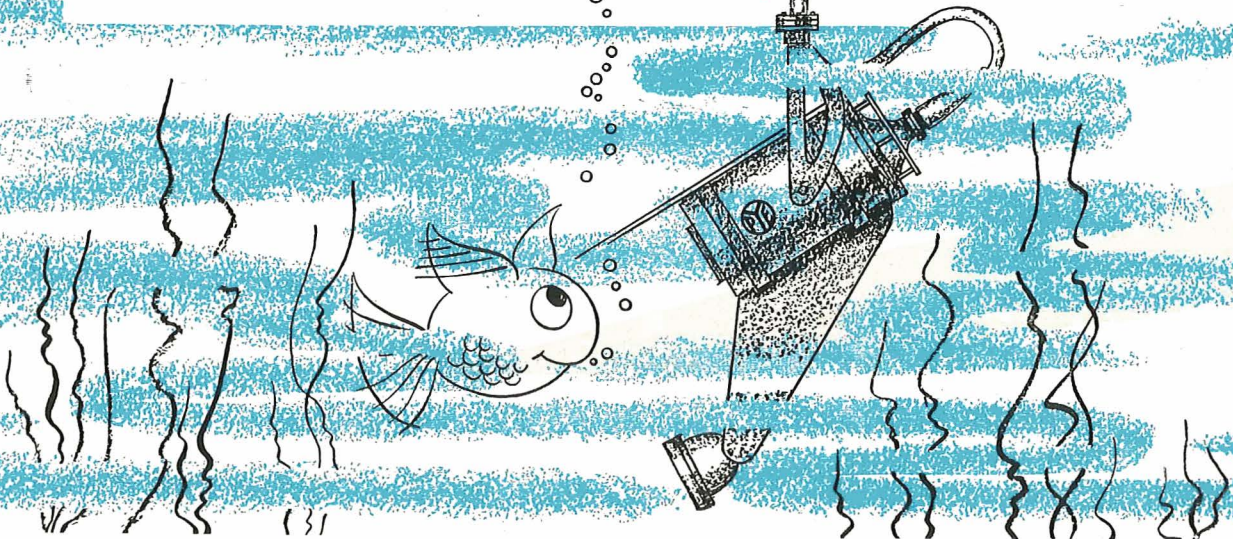

A remarkable
NEW *head telephone set*
by Standard

Here's the most interesting telephone news for years! A new, lightweight, one-piece head telephone set moulded in nylon plastic and weighing only 4 oz!

Available in black or ivory finish, this revolutionary instrument, designed, developed and manufactured by *Standard Telephones & Cables, Limited*, for telephone switchboard operators, introduces an entirely new concept in comfort, elegance, economy and operational efficiency.

No other operator's head telephone set available to-day has all these additional advantages:—

*Ask for brochure T.D.16
which fully describes the*



Standard Telephones and Cables Limited

Registered Office: Connaught House, Aldwych, W.C.2

TELEPHONE DIVISION

- * **Self-contained nylon moulding incorporating high - quality, super-sensitive transmitter and receiver.**
- * **Weight only 4 oz! (compare this with the 15-oz weight of the conventional head and breast-type operators' set).**
- * **Attractive appearance.**
- * **Only one instrument cord required.**
- * **Finely balanced to ensure comfort and stability.**
- * **Mechanical shock absorber to avoid breakage at transmitter horn junction.**
- * **Adjustable head grip with resilient band.**
- * **Moulded frame for operator's identification label.**



4406

Telephone Head Set

another advance by
Standard

OAKLEIGH ROAD · NEW SOUTHGATE · LONDON N.11.

'OPTIMUM SOLUM SUFFICIT'

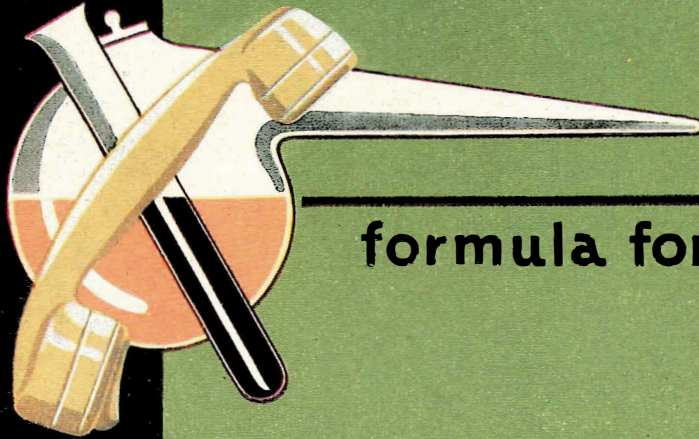

formula for quality

'GOOD ENOUGH' is our standard, established as firmly today, as it has been throughout the past. For over half a century, Telecommunication Equipment by ERICSSON has always borne the seal of high quality. Throughout the whole of our Works, appreciation of this has become an endowment that sets a background to every phase of design and production. Modern Plant allied to the highest technical resources is the 'sine qua non' for the exacting standards imposed by modern conditions.

An outstanding example of the unity of these essential ingredients becomes apparent in the finish of all our products. Electro depositions and organic surface coatings are formulated and controlled directly by an extensive PROCESS LABORATORY so that at every stage expert knowledge is applied to ensure the superfine finishes which stand up to the most arduous conditions of service and climate.

What better FORMULA FOR QUALITY?



HEAD OFFICE: 22, LINCOLNS INN FIELDS, LONDON W.C.2
WORKS: BEESTON, NOTTINGHAM & SUNDERLAND

DESIGNED to meet *G.P.O. specification*

TUNGSTONE PLANTÉ CELLS are being regularly supplied to the British Post Office and Post and Telegraph Departments in many countries overseas. They conform fully to G.P.O. Standard specifications.

OPEN TYPE CELLS

Similar to the illustration here, these are available in glass and/or lead lined wooden boxes in capacities from 100 a.h. to 5000 a.h.

REPLATALS

We are in a position to supply plates for the replating of existing Planté Batteries.

ENCLOSED TYPE CELLS

As illustrated below, these are in moulded glass boxes with sealed-in lid. Capacity range from 10 a.h. to 200 a.h.

PORTABLE TYPE BATTERIES

A range of portable type Batteries is in regular production, made to G.P.O. specifications, for ancillary duties.

Overseas customers are invited to cable or write their enquiries for batteries or parts. Visitors to London are welcome at our offices. (Just off Fleet Street.)

50 Cells. BSSDW. 25.
1200 a.h. at the 9-hour rate.
Installed for the
General Post Office

TUNGSTONE

REG^d TRADE MARK

BATTERIES

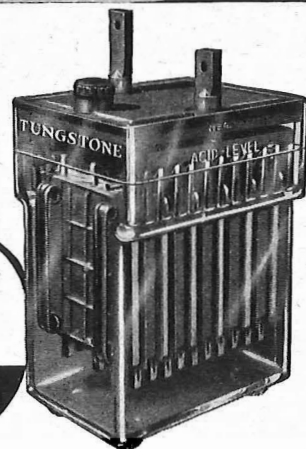



Britain's microwave leaders announce

The New 60/120-CIRCUIT U.H.F. TELEPHONY SYSTEM SPO 5500

THIS FREQUENCY-MODULATED SYSTEM, conveying either 60 or 120 circuits, operates in the 1700-2300 Mc/s band. Long systems show a minimum of modulation distortion since non-demodulating repeater stations are used. The system handles two super groups of 60 circuits each, with a total signal/noise performance in the worst channel only 6 db. below that recommended for C.C.I.F.

international coaxial cable networks.

The most modern construction practice permits all panels to slide into place on guides, being connected into service by plug-in sockets. Wiring is not disconnected for the removal of a panel.

Each rack has a meter panel, giving readings of anode and grid currents, crystal currents, RF amplifier output power and all non-mains

voltages.

No voltage higher than 300V is encountered in the equipment.

The use of coaxial cable for feeders eliminates the expense of wave-guides.

A rack complete with transmitter and receiver is single-sided, so that two racks may be mounted side-by-side or back-to-back. They are economical of floor space, occupying only 20½ in. × 8½ in.

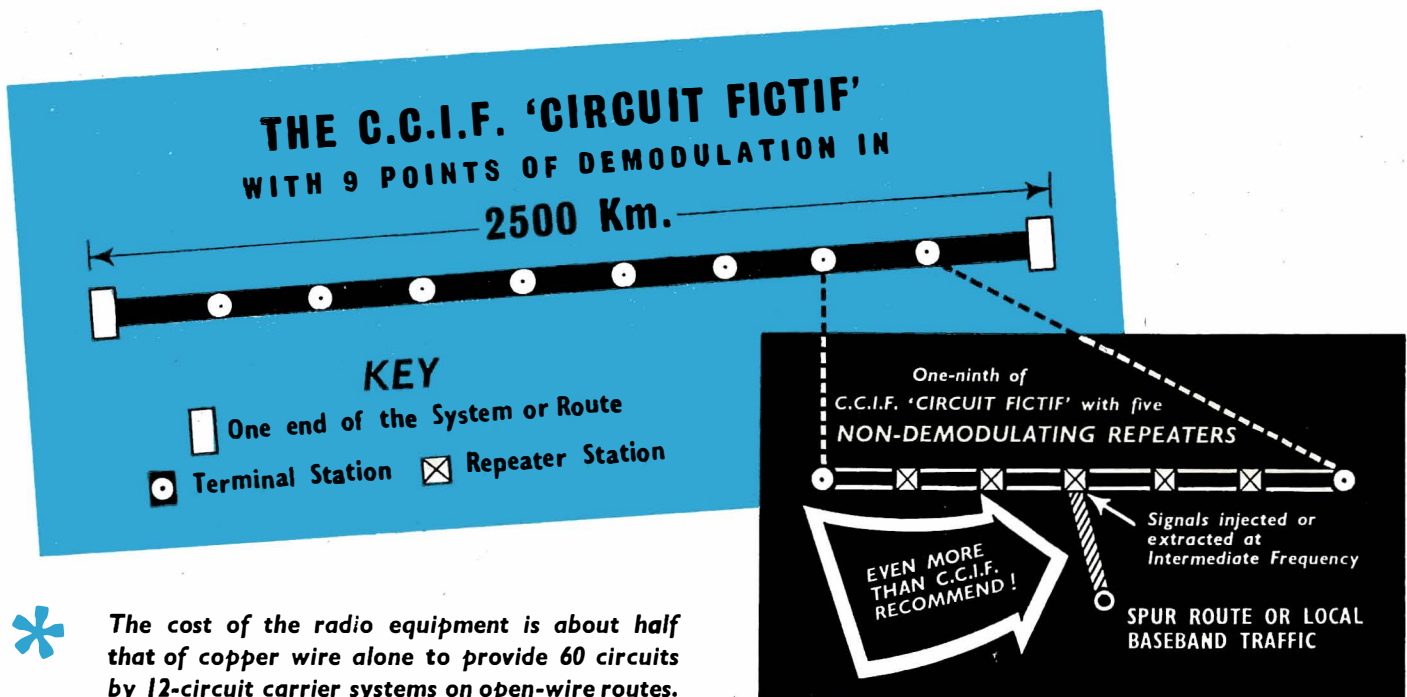

* The cost of the radio equipment is about half that of copper wire alone to provide 60 circuits by 12-circuit carrier systems on open-wire routes.

★ Conveying one super-group of 60 circuits, the SPO 5500 system achieves, in all respects, the performance laid down by C.C.I.F. for international co-axial cable networks.

★ In addition, the channel spacing, intermediate frequency and transfer levels comply with the standards laid down in the C.C.I.R. Documents 66 and 69.

★ Spur routes and local base-band traffic are catered for in the design of the system, since at repeater stations any signal from the baseband is injected or extracted without demodulation of the "through traffic."

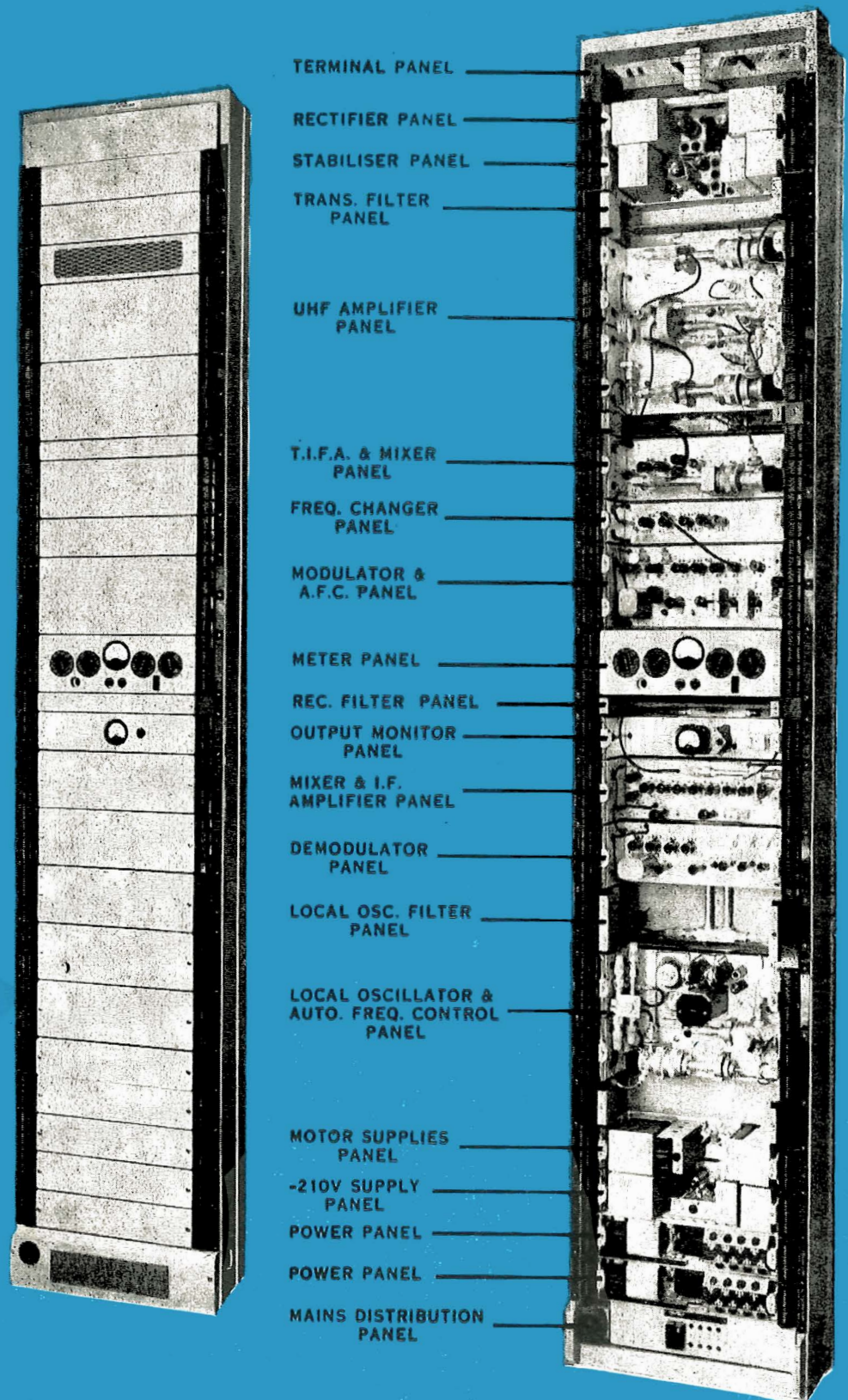

lead the march of progress in the microwave radio field.

In addition to telephony, G.E.C. television links are playing vital roles in many national and international networks, and are in continuous manufacture both at home and abroad. Up-to-date equipment design promotes economy of space, accessibility of components, and ease of maintenance in all G.E.C. telephone and television transmission equipment.

ANOTHER STROWGER EXCHANGE

Telephone Bhavan is the new telecommunications centre in the heart of Calcutta built to accommodate two automatic exchanges and a trunk exchange. Its opening marks the completion of stage two in the conversion programme of the Calcutta area from manual to automatic working. The system chosen is Strowger two-digit Director working and will ultimately comprise 15 automatic exchanges serving an initial total of 60,000 subscribers.

The installation of the five exchanges in stages one and two of the scheme was carried out by A.T. & E. Co. Ltd. who also supplied the bulk of the automatic switching equipment. This Company is actively associated with Indian Telephone Industries Ltd. who will be responsible for the future manufacturing programme to the requirements of the Indian Posts & Telegraphs Department. The Type 32A Mark II selector is the basic selecting mechanism. Its maintenance requirements are limited to regular lubrication and the performance of simple operational tests. Its performance and capabilities are more than adequate for all modern requirements. It is reliable. These are the factors upon which the administration and the subscriber both depend for economic service and continuous operation.

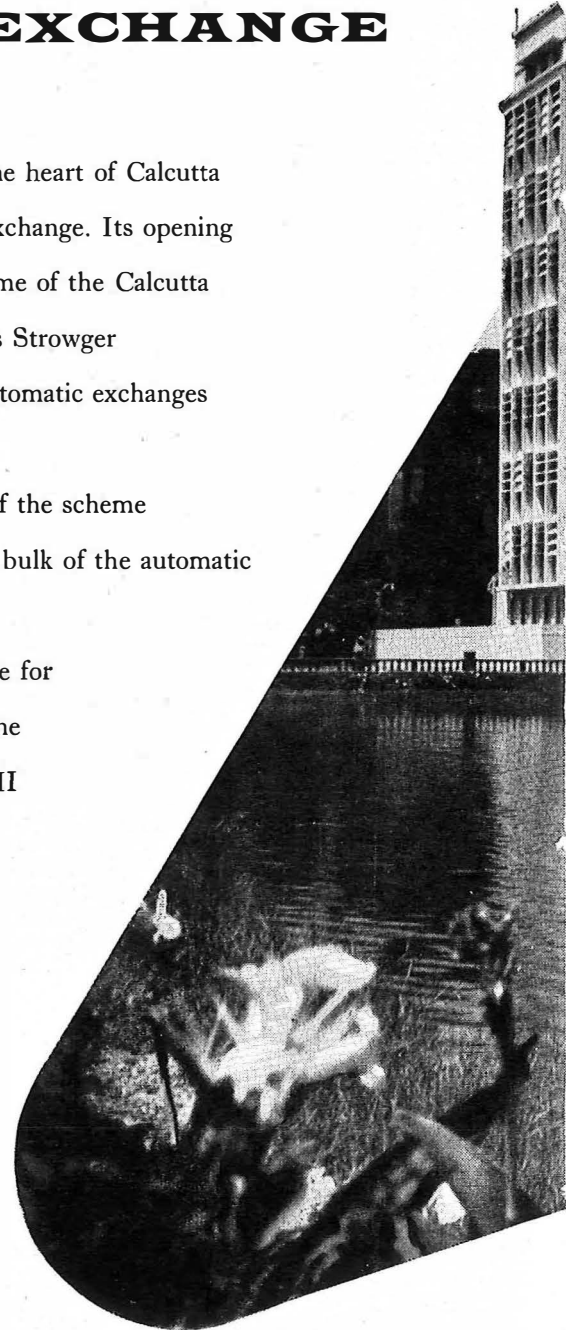

AUTOMATIC TELEPHONE & ELECTRIC
LONDON - LIVERPOOL



ERIC CO., LTD



1 V.F.

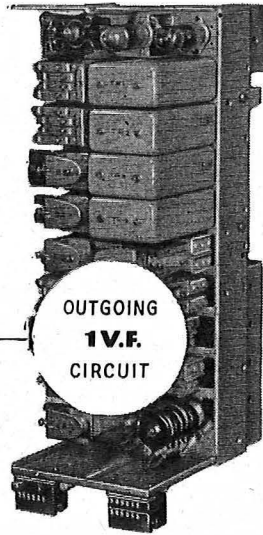
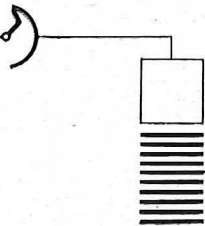

CARRIER CHANNELS
RADIO LINKS
LONG D.C. JUNCTIONS
D.C. ISOLATED LINES
TELEPHONE PHANTOMS
ETC. ETC.

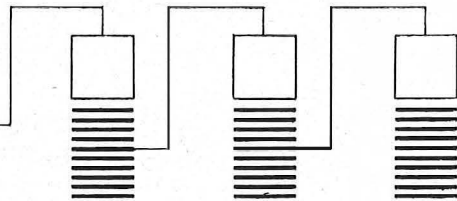
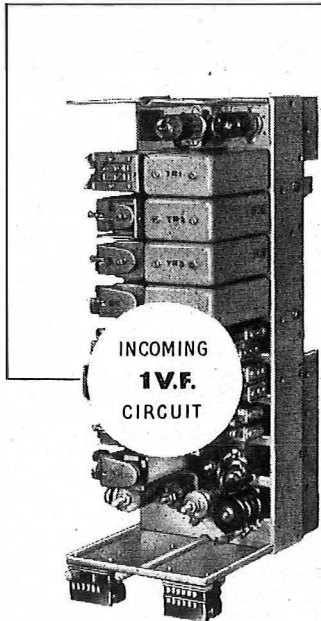

SIEMENS

TELEPHONE BRANCH.

SIGNALLING & DIALLING SYSTEM

Siemens Brothers Single Voice Frequency (1 V.F.) System has been designed to provide signalling and dialling facilities over commercial speech channels and possesses the following major advantages :—

- * The system can be applied to any speech channel.
- * The overall loss on single or tandem links can be ignored provided speech is acceptable.
- * The system is basically simple and does not complicate the line terminal or channelling equipment.
- * The system conforms to C.C.I.F. performance recommendations.
- * The standard design is suitable for trunk or junction operation.
- * The system can be arranged for unidirectional or both way signalling and dialling.
- * The equipment is relay-set mounted in accordance with latest telephone exchange practice.
- * The voice frequency receiver is incorporated in the terminal relay set.
- * The equipment can be installed with the telephone equipment and served from exchange power supplies.
- * The latest standard components are used throughout.
- * The system requires negligible maintenance attention.
- * The system is designed to provide the required facilities on a strictly economic basis.

BROTHERS & CO. LIMITED

WOOLWICH, LONDON, S.E.18.

Telephone: Woolwich 2020

Member of the A.E.I. Group of Companies.

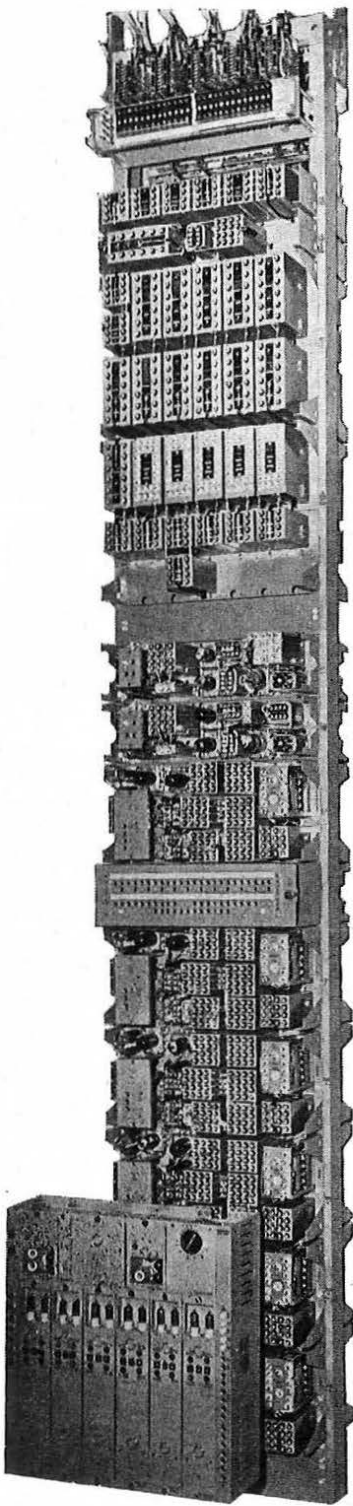

SKILLMAN

Short Distance Carrier

With UAX/RAX Signalling!

- * Extra Channels for new or existing Rural Automatic Exchanges with all signalling facilities necessary for parent and dependent exchange working.
- * Rural exchanges may be converted to dial working without increasing the number of line pairs required for junctions.
- * Steady-state signals for the basic line signals with ancillary signals by V.F. tones. Complete voice immunity on all signals with no elaborate timing or guard circuits.
- * For use on cable or open-wire with 4 or 5 kc/s channel spacing, giving circuits of zero transmission loss.
- * Systems supplied complete with relay sets giving the normal junction signalling conditions of the Unit Automatic Exchange 12, 13 or 14, for connection to the normal junction equipment at parent exchange and U.A.X.

← The small panel on the left is the same as that on the right and replaces the entire bay shown behind. →

T. S. SKILLMAN & CO. LTD., 199 Uxbridge Road, Hanwell, London, W.7

T. S. SKILLMAN & CO. PTY. LTD., Cammeray, Sydney, N.S.W.

SKILLMAN CARRIER EQUIPMENT HAS BEEN SUPPLIED TO ENGLAND FOR OTHER THAN G.P.O. APPLICATIONS, TO AUSTRALIA, NEW ZEALAND, BELGIUM AND EGYPT, AND ENQUIRIES ARE INVITED FOR REPRESENTATIVES ELSEWHERE



Full signalling facilities for:

Bothway Dialling

**Coin Collecting Box
Discrimination**

**Routing to Auto or Manual
Equipment at the Parent
Exchange**

**Manual Hold on calls to the
Parent Exchange**

**Trunk Offering to the UAX
subscriber**

Dependent Exchange Working

Normal line from U.A.X. to parent exchange. This is cut at "X" and reconnected as shown

Five new lines with all discriminating facilities and superior transmission. Connections at each end are identical with connections for D.C. Junction.

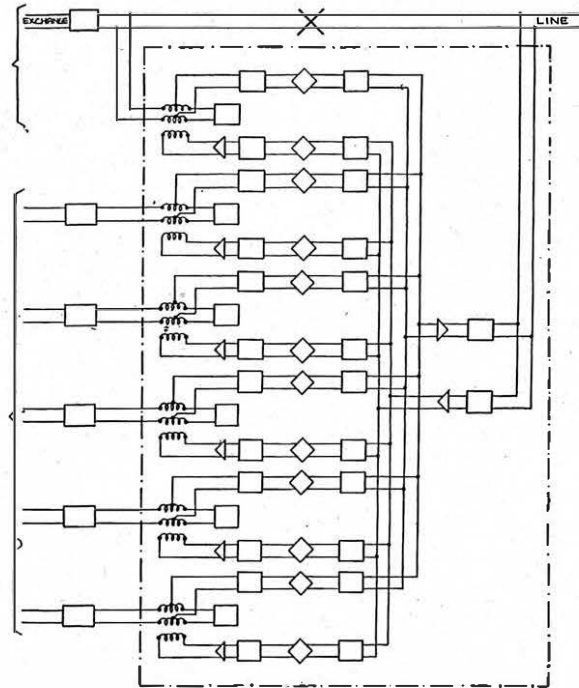

All the equipment within the dotted line is mounted on the panel shown below.

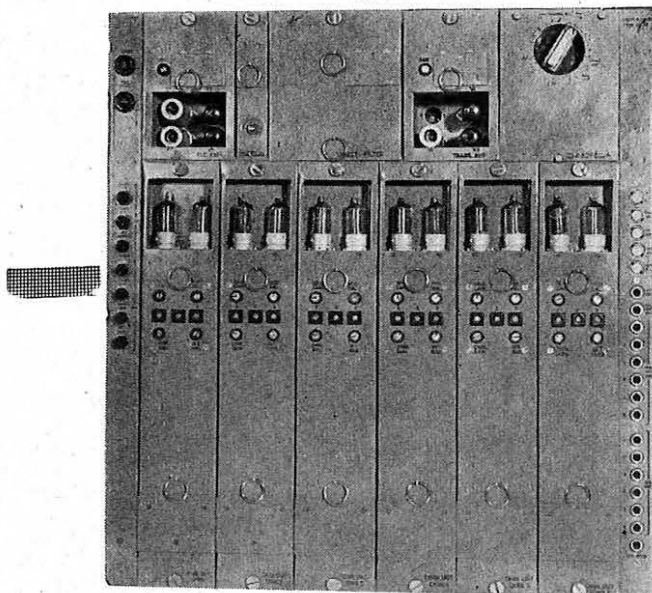

SKILLMAN'S are world pioneers of short haul or "junction" carrier systems. Over £500,000 worth of the old style equipment indicated opposite is in service, much of it for over 4 years.

The miniaturised form is now available, on a 21" panel with 60 channel ends plus power supply on one 19" rack. Installation involves connecting only new junction relay groups, power (A.C.) and carrier supply and deloading the junctions.



SE50 Selector...

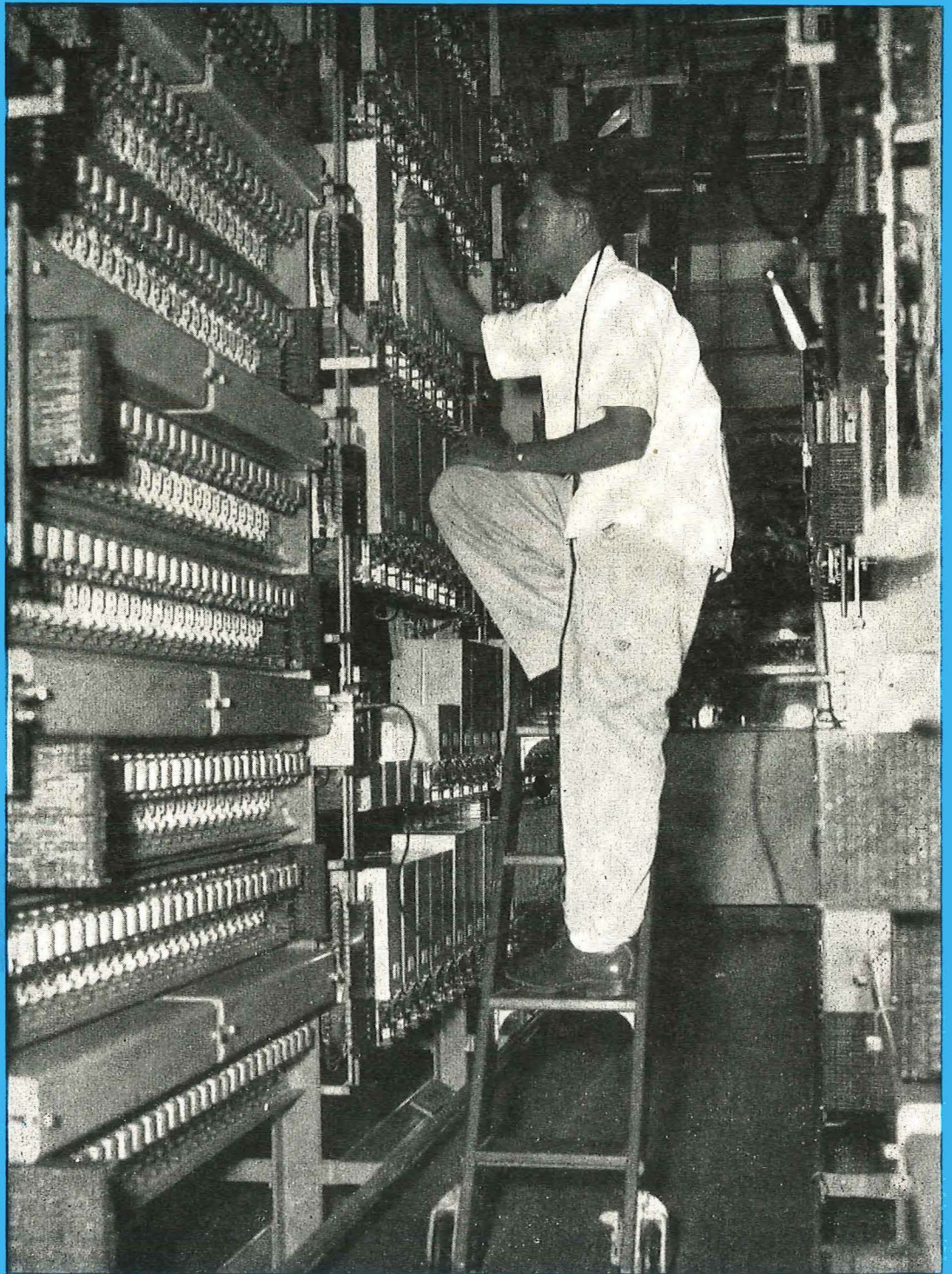

Local technician at work on the new exchange at Kuching — the first exchange to use SE50 Selectors in S.E. Asia.

..now cutting maintenance costs in South-East Asia!

THE NEW automatic exchange at Kuching, Sarawak, in the Island of Borneo, is the first main exchange using SE50 Selectors to be commissioned in South-East Asia. The initial capacity of the exchange is 800 subscribers, but it is designed to have a capacity of 2,000 subscribers. SE50 Selectors have been life-tested to five times the British Post Office requirements for two-motion selectors, and their remarkable life, extraordinary reliability and ease of maintenance render them particularly suitable for an installation of this kind. The SE50 sets new standards in automatic exchange equipment. The mechanism is robust and simple; all adjustments are independent and can be made without disturbing those previously carried out. These characteristics mean that the SE50 can be maintained by less-skilled staff—providing yet another saving in maintenance costs.

- ★ Each unit can be removed from the frame for adjustment and replaced without affecting its own or other settings.
- ★ Drift adjustments are eliminated and all adjustments are independent.
- ★ Auxiliary contact spring/sets are identical with those used in G.E.C. P.10 type relays (British Post Office 600 type). No special adjustment technique is required.

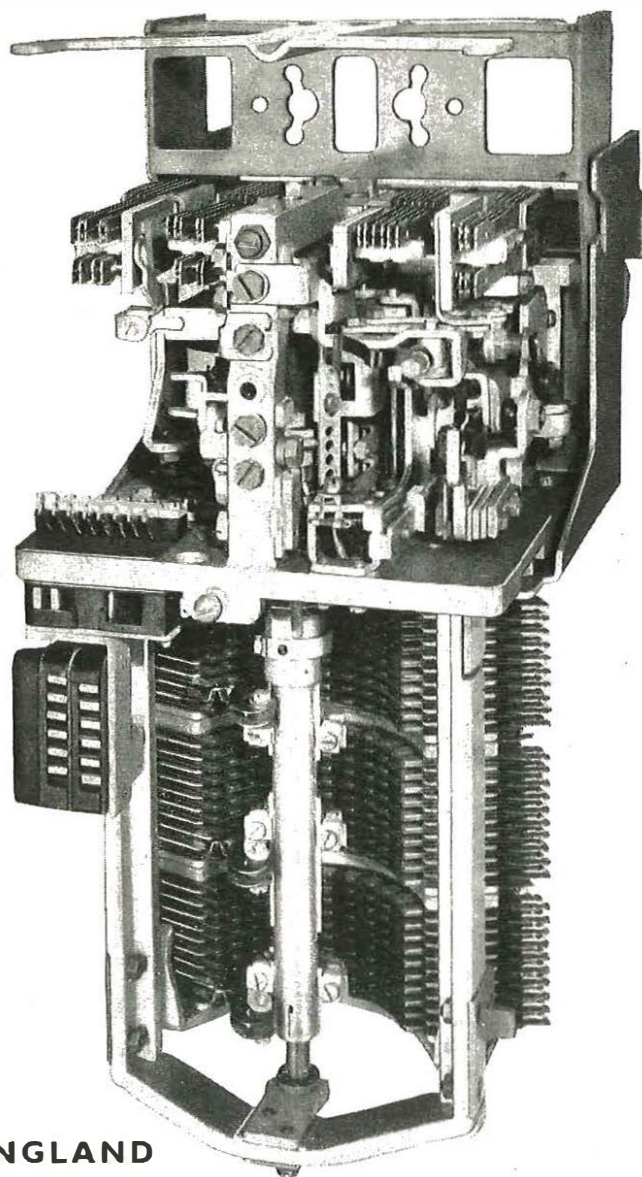

THE GENERAL ELECTRIC CO. LTD. OF ENGLAND
TELEPHONE, RADIO AND TELEVISION WORKS, COVENTRY, ENGLAND.

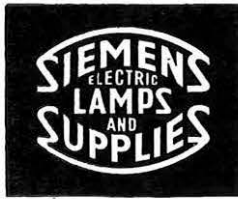

COLD CATHODE DIODES

First of a new range of miniature Cold Cathode Diodes, the Siemens 2N1a is applicable to a variety of electronic functions including :—

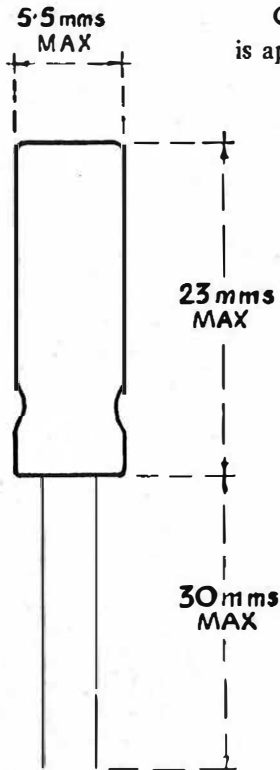

Simple relaxation oscillators

Simple Pulse generating circuits

Gating circuits

DC. level changers (*for use in direct coupled amplifiers, etc.*)

Information storage

Test Probes

Radio Frequency Indicators

Coupling Devices

Low current stabilizers

Blown Fuse indicators

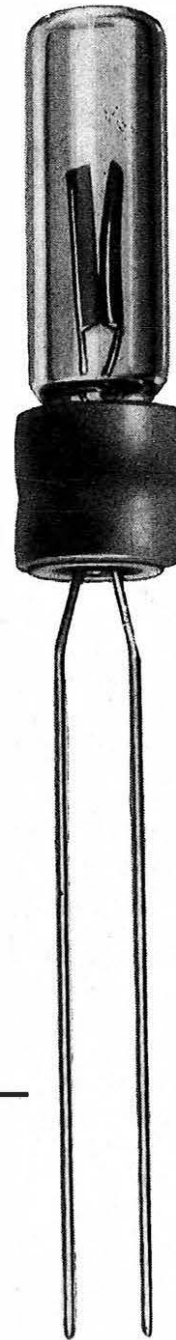

CHARACTERISTICS

Maximum Striking Voltage	=	85 V
Maximum Maintaining Voltage at 0.5mA	=	65 V
Maximum Continuous Current	=	1 mA
Nominal Ionisation Time	=	50 μ s
Nominal Deionisation Time	=	150 μ s

Details of application and further information from :—

SIEMENS ELECTRIC LAMPS & SUPPLIES LIMITED

38-39 UPPER THAMES STREET, LONDON, E.C.4.

Member of the A.E.I. Group of Companies.



By Appointment to the Professional Engineer

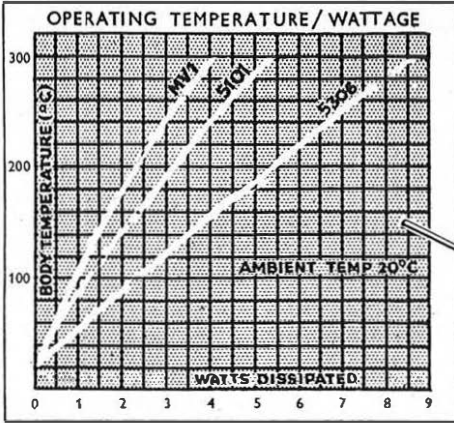

MIDGET WIREWOUND VITREOUS RESISTORS

MINIATURE EQUIPMENTS
DEMAND **MIDGET** RESISTORS

Dimensionally
Painton **MIDGET** resistors
offer the **MAXIMUM WATTAGE DISSIPATION**
MAXIMUM OHMIC RANGE
MAXIMUM SAFETY FACTOR

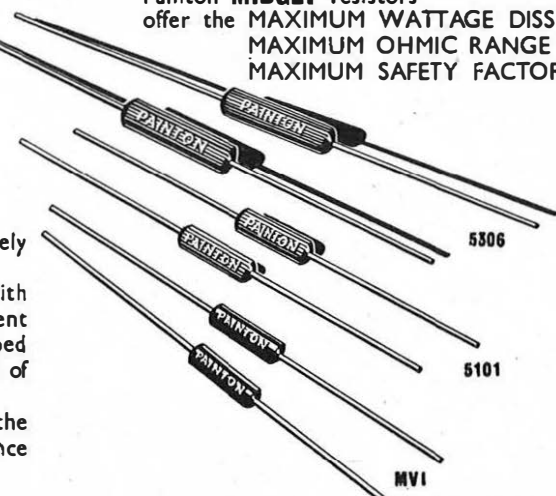

In the Heavy Duty **MIDGET** Range, the extremely high wattage dissipation is achieved by:
(a) the use of a sintered alumina ceramic former, with thermal conductivity approximating steel (Patent 626128), in conjunction with a Painton glaze developed to match the thermal and mechanical properties of sintered alumina,
(b) the exceptional strength and conductivity of the Painton "Intermediate Wire Process" of resistance termination (Patent 575297).

Range	Type	Resistance Range Ohms		Tol.	Rating Watts		Max. Working Temp.	Temperature Coefficient	DIMENSIONS			
		Min.	Max.		Normal 20 °C.	Tropical 70 °C.			Length	Diam.	Lead	
											Length	Material
Standard	MVI	1 10	9.99 4700	10% 5%	4	3	300 °C.	BELOW 100°— NEGLIGIBLE ABOVE 100°— 0.01%/°C.	15" 32	12" 64	1" 4	20 S.W.G.
Heavy Duty	5101	1 10	9.99 4700	10% 5%	5.5	4	350 °C.	BELOW 100°— NEGLIGIBLE ABOVE 100°— 0.01%/°C.	15" 32	12" 64	1" 4	Silver Clad
Heavy Duty	5306	10	15,000	5%	8.5	7	350 °C.	BELOW 200°— NEGLIGIBLE ABOVE 200°— 0.01%/°C.	13" 16	9" 32	1 1/2"	Copper Wire

PAINTON
Northampton England

ATTENUATORS AND FADERS · STUD SWITCHES · TOGGLE SWITCHES · PUSH BUTTON SWITCHES
FIXED AND ADJUSTABLE WIREWOUND RESISTORS · HIGH STABILITY CARBON RESISTORS
"METLOHM" STABILITY RESISTORS · WIREWOUND POTENTIOMETERS · MIDGET R.F. CHOKES
· KNOBS, DIALS & POINTERS · TERMINALS · PLUGS AND SOCKETS

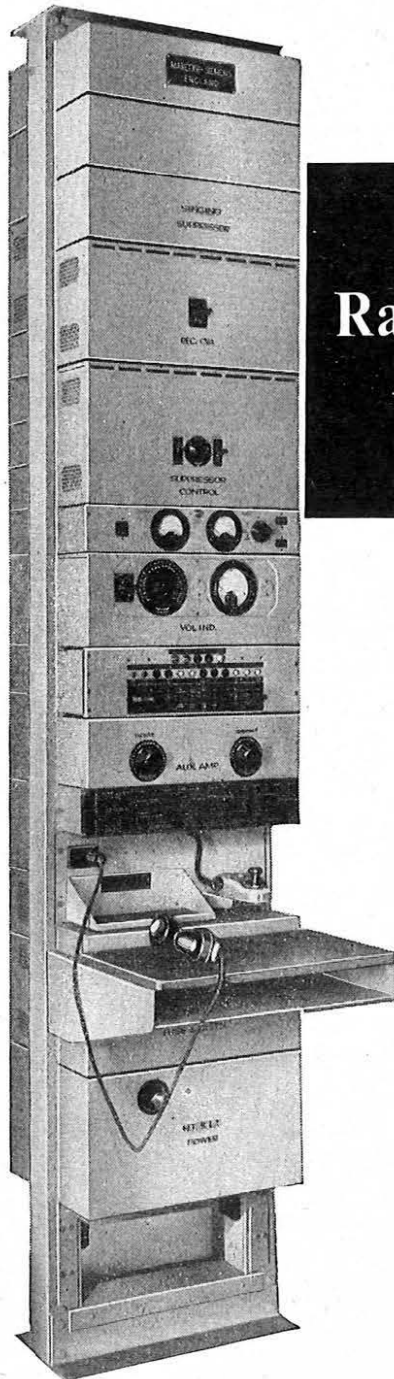

MARCONI-SIEMENS
Radio Telephone Terminal
TYPE B
(HW 21)

The type B (HW 21) terminal provides a satisfactory junction of HF radio with line or cable telephone and telegraph circuits. Its primary function is to eliminate the unstable conditions due to the inherently high gain in the radio link by ensuring that the radio circuit is operative in one direction only at any one instant. It also provides facilities for controlling the signal levels to the line or to the radio transmitters for discriminating against line and radio noises, and for simple privacy working. Its features include semi-automatic operation, two or four-wire line connection, electronic VF switching, radio calling facilities, and centralised test and monitoring facilities. It is self-contained for AC mains supply.



THE LINK BETWEEN RADIO AND LINE COMMUNICATIONS

Full details of this and other Marconi-Siemens equipment, which provides completely integrated radio and line telegraph and telephone systems may be obtained from either—



MARCONI'S WIRELESS TELEGRAPH COMPANY LIMITED, CHELMSFORD, ESSEX
 OR SIEMENS BROTHERS & CO., LIMITED, WOOLWICH, LONDON, S.E.18
 MS 1

Improved filter units

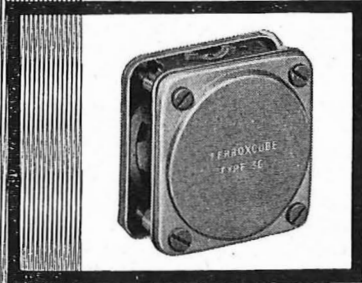
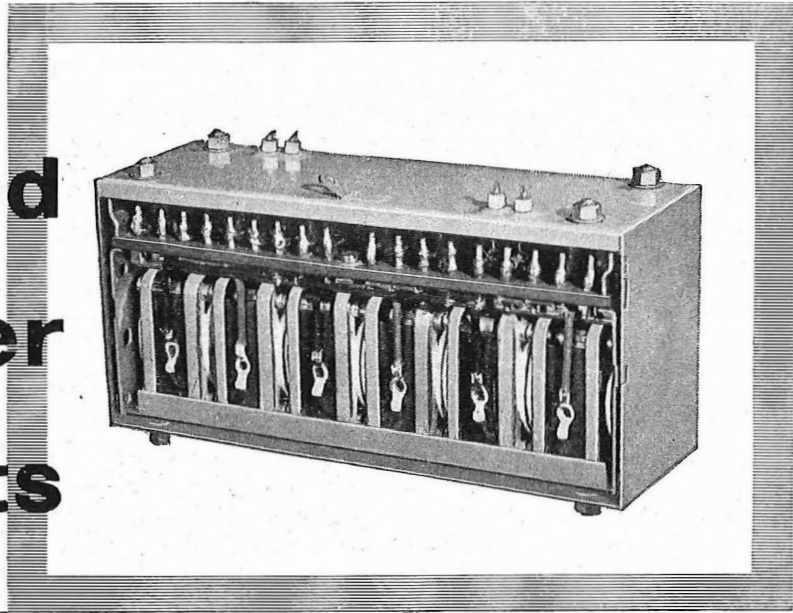

with Ferroxcube pot cores

- 1 *High performance combined with small size and light weight.*
- 2 *Designed and built to customers' individual requirements.*
- 3 *Long term stability, even under conditions of temperature variation.*

High quality electrical filter units built around Ferroxcube cores can now be supplied to communications equipment designers' individual specifications. These filter units have significant advantages over comparable types designed without the use of Ferroxcube, particularly in the frequency range 300 c/s to 500 kc/s. For audio frequencies the use of Ferroxcube cores permits the winding of compact coils with very high inductances. This results in a considerable reduction in the size and cost of the associated condensers and hence of the filter unit as a whole. The high Q values obtained for a given volume, especially above 10 kc/s, enable sharp cut off characteristics and low pass-band losses to be achieved, while negligible stray flux facilitates the production of compact and mechanically robust filters. Electrical filter units are among a number of high quality components now being made available by Mullard. Full details of the complete series of components will be gladly supplied upon request.

Mullard



'Ticonal' alloy permanent magnets
Magnadur permanent ceramic magnets
Ferroxcube ferro-magnetic cores.

MULLARD LTD · COMPONENTS DIVISION · CENTURY HOUSE · SHAFTESBURY AVENUE · WC2

(M1463A)

Ah! the 1956
MARCONI
INSTRUMENTS
Catalogue



25 NEW INSTRUMENTS INCLUDED

The publication of a new edition of the Complete Catalogue of Marconi Instruments is an annual event which is eagerly awaited by everyone in the world of electronics. The 1956 edition, now being distributed, once again brings the record of developments in the radio communication and industrial fields up to date, and provides a comprehensive survey of all Marconi measuring and test equipment, including twenty-five new instruments.

The demand for the catalogue is greater than

ever, and reflects the confidence of users of Marconi instruments everywhere. The reason for this confidence in our products is not hard to find: we believe in paying meticulous attention to detail in all phases of design, development and manufacture, ensuring that Marconi instruments combine supreme reliability with outstanding technical merit, plus that little extra in the way of operational convenience. Our new catalogue has been produced in the same spirit.

MARCONI
INSTRUMENTS

AM & FM SIGNAL GENERATORS · OSCILLATORS · VALVE
VOLTMETERS · POWER METERS · Q METERS · BRIDGES
WAVE ANALYSERS · FREQUENCY STANDARDS · WAVEMETERS
TELEVISION AND RADAR TEST EQUIPMENT · AND SPECIAL
TYPES FOR THE ARMED FORCES

MARCONI INSTRUMENTS LTD., ST. ALBANS, HERTFORDSHIRE. TELEPHONE: ST. ALBANS 6160/9

30 Albion Street, Kingston-upon-Hull, Telephone: Hull Central 16144. 19 The Parade, Leamington Spa, Telephone: 1408

Managing Agents in Export: MARCONI'S WIRELESS TELEGRAPH CO. LTD., MARCONI HOUSE, STRAND, LONDON, W.2.
TC73

G.N.T.

MORSE TRANSMITTERS

MODEL 113 Speed range: ►
5-35 words per minute

MODEL 112 Speed range:
13-250 words per minute
▼

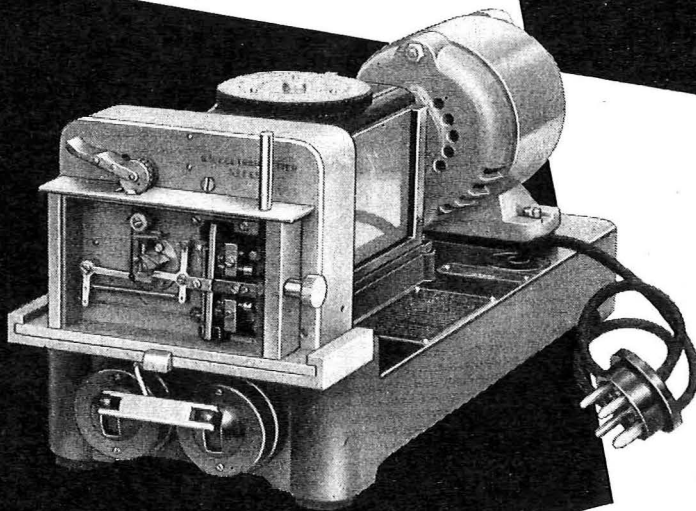
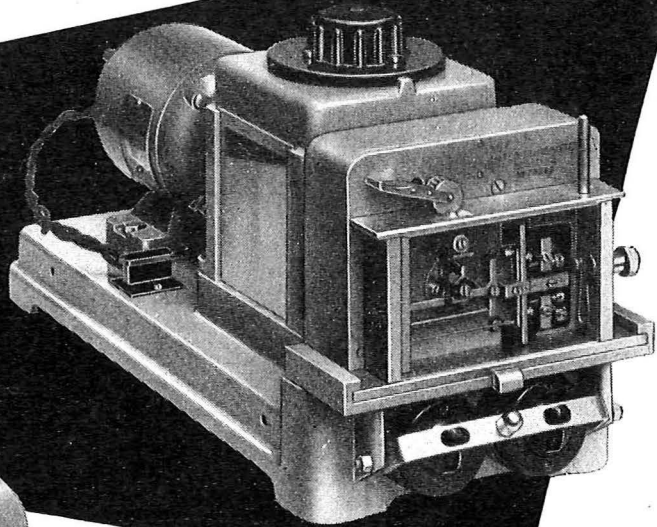

Absolutely constant speed at
all settings notwithstanding
large voltage variations.

Noted for easy maintenance
and quick adjustment.

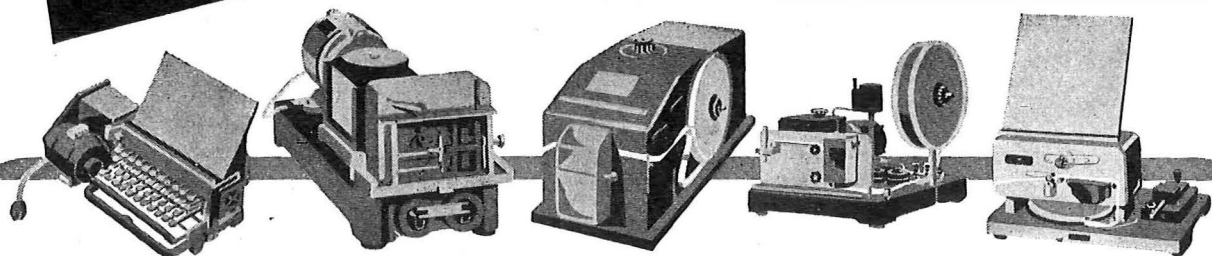

GREAT NORTHERN TELEGRAPH WORKS

DIVISION OF THE GREAT NORTHERN TELEGRAPH CO. LTD.

4, SYDHAVNS PLADS
COPENHAGEN SV, DENMARK

LONDON OFFICE: 5, ST. HELEN'S PLACE
LONDON E. C. 3.

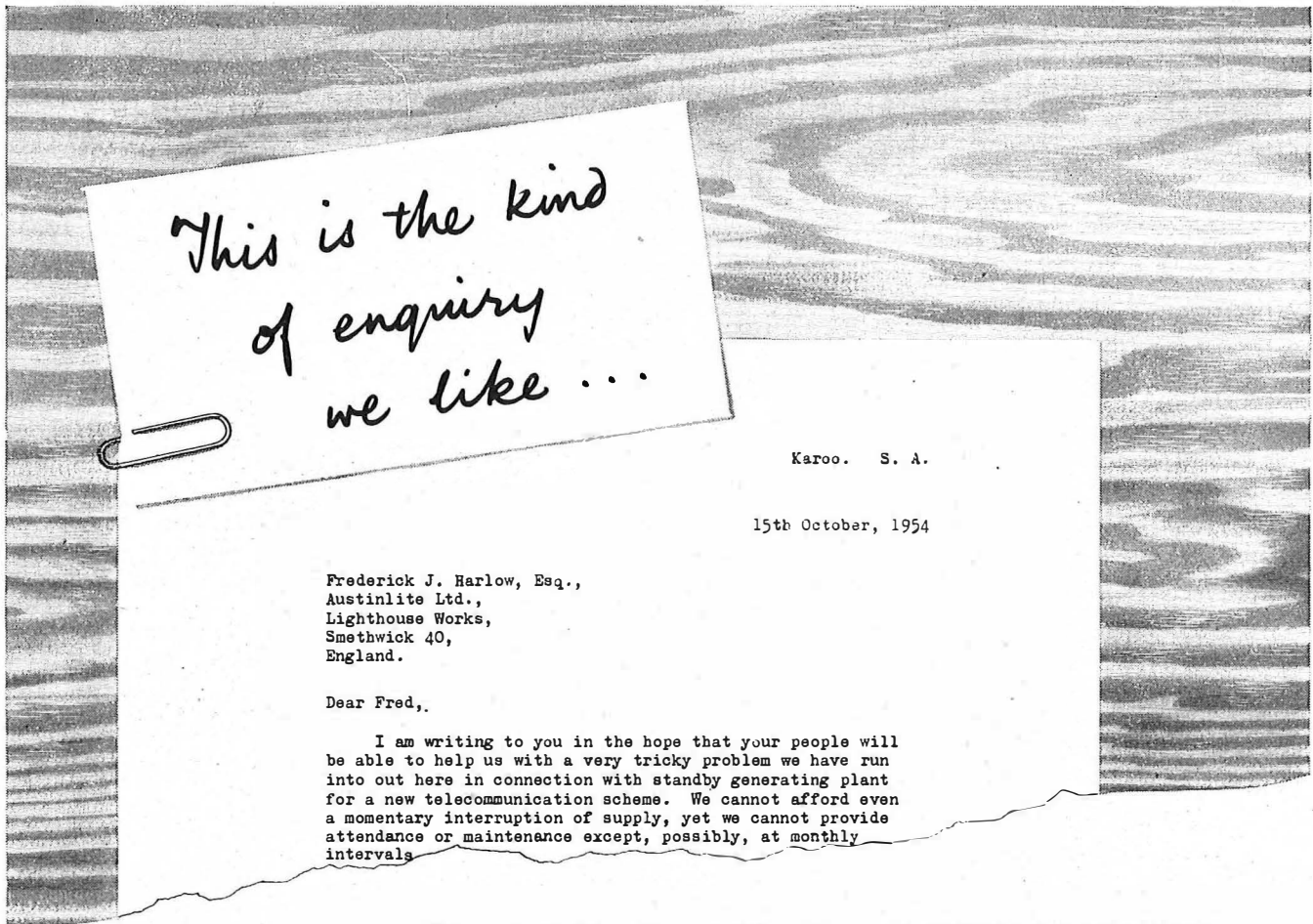

This is the kind
of enquiry
we like ...

Karoo. S. A.

15th October, 1954

Frederick J. Harlow, Esq.,
Austinlite Ltd.,
Lighthouse Works,
Smethwick 40,
England.

Dear Fred,

I am writing to you in the hope that your people will be able to help us with a very tricky problem we have run into out here in connection with standby generating plant for a new telecommunication scheme. We cannot afford even a momentary interruption of supply, yet we cannot provide attendance or maintenance except, possibly, at monthly intervals

The more tricky the problem, the more arduous the conditions under which the equipment must operate, the better we like it. Difficult, unusual generating plant is our metier. It does not matter how long it must run without attention. It does not matter whether there is a mains supply or not. Nor if the supply is erratic and unreliable. Even if the requirements do not come within our standard range Austinlite plant can be designed which will ensure continuous, steady and extremely reliable supply.

During the past 25 years Austinlite plant has been steadily developed, always with the emphasis on quality and dependability. We can now provide automatic generating plant of many types in sizes from 1.4 to 250kVA, for continuous unattended operation, or for mains standby work — to the strictest no break specification where necessary. However difficult a particular problem may be, we have good reason for the confidence with which we affirm that Austinlite can tackle it.

In this country our plant is used by the G.P.O., the Ministry of Civil Aviation and British Railways. It is installed in many parts of the world in lighthouses where reliability is vital. It is in operation in South Africa, Australia, Denmark, the U.S.S.R., Malta, Syria, New Zealand and Norway; as well as a number of tropical countries including Nigeria, Malaya and Borneo.

Austinlite **AUTOMATIC GENERATING PLANT Tailor-made by STONE-CHANCE LTD.**

(The makers of Sumo Pumps and Stone-Chance Lighthouses)

28 ST. JAMES'S SQUARE, LONDON, S.W.1. Telephone: TRAFALGAR 1954

There's much to be said for . . .

CONSTRUCTION: Toroidally wound auto-transformers, with tracks formed on one face of the windings.

CORE: Wound from a continuous strip of low loss electrical steel in a similar manner to the well-known C core construction.

INSULATION: Specially processed plastic mouldings ensure minimum shrinkage due to heat and continuous use, and prevent any possibility of the turns slackening.

WINDING: Of high conductivity copper, insulated with a synthetic enamel of the polyvinyl acetal-phenal formaldehyde resin type, giving good space factor, exceptionally high abrasion resistance and prolonged heating resistance.

FRAME: Of die cast aluminium, incorporating long spindle bearings and mounting feet to ensure accuracy and rigidity of the mechanism in relation to the fixing holes.

BRUSHES: The brushes are of a special carbon chosen for its contact resistance characteristics, shaped to give minimum loss, maximum strength and longest life.

There are 4 models of the Berco Rotary Regavolt available :-

Model	Max. Input Volts at 50/60 cycles	Max. Output Voltage Range at no load	Rated Current	Weight	PRICE £ s.
41A	250	0-250	0.8	4½ lbs.	6 12
41B	115	0-135	2.25		
42A	250	0-270	2.0	6½ lbs.	7 18
42B	115	0-135	5.0		

The Berco Rotary Regavolt provides a highly economical, compact and reliable means of obtaining a continuously variable output voltage, without the heat losses associated with resistances. Its outstanding advantage over resistance control is that any alternating current load within normal rating can be controlled from zero to full voltage without the necessity of special designing for individual applications. Thus, one rotary Regavolt can be used in place of a number of adjustable resistances. In addition, an increase in voltage, above the main supply, can be obtained with three of the four Regavolt models. This is an especially valuable feature when the supply voltage is low.

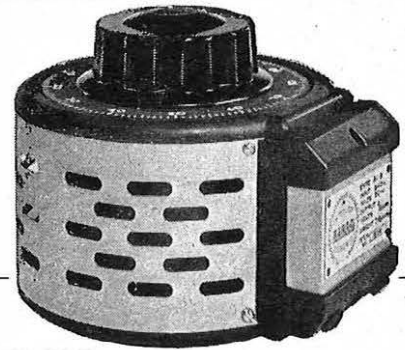

...BERCO ROTARY REGAVOLT



★ For full details and prices write to:-

THE BRITISH ELECTRIC RESISTANCE CO. LTD.,

Queensway, Ponders End, Middlesex. Telephone: HOWard 2411. Telegrams: Vitrohm, Enfield
Specialists in the control of current and voltage for more than 25 years

BR1291-AH

PYPECOVER

a quicker, cheaper, better way to protect bunched wires and cable connections

JUST ZIP IT ON AND OFF

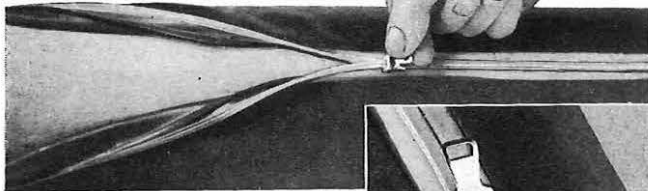

This new patented covering was originally developed for covering pipes and ducts and is now used extensively for covering bunched wires and cable connections to switchboards in the Radio, Television, Telephone and Telegraph industries. Pypecover has many outstanding advantages over the conventional methods of protection.

Pypecover consists of Poly-Vinyl Chloride Sheet with a longitudinal airtight and waterproof Flexigrip slide fastener. It is supplied in lengths up to 100 ft. and in widths up to 75 in. Pypecover can be fitted in a fraction of the time necessary to protect bunched cables by the old method. Suitable for temperatures from -60°F to +200°F. Non-flammable and will not support combustion. Insulation resistance 100,000 megohms. Can be removed and replaced without damage to cover or cables JUST ZIP IT ON AND OFF.

LOCKS IN PLACE



SAMPLE LENGTH with technical details and prices on request

Sole Licensees: **VICKERYS** LIMITED

4 LAMBETH PALACE ROAD, LONDON, S.E.1

Telephone: Waterloo 7041/2

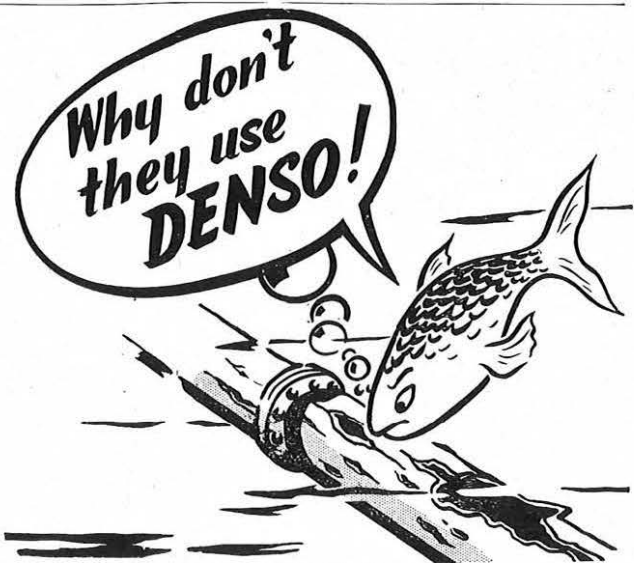

DENSO

Industry's protection against CORROSION

Full information from

WINN & COALES LTD.

DENSO HOUSE · CHAPEL ROAD · LONDON, S.E.27

Telephone: GIPsy Hill, 4247 (3 lines)



Telegrams: Denselte, Westnor, London.

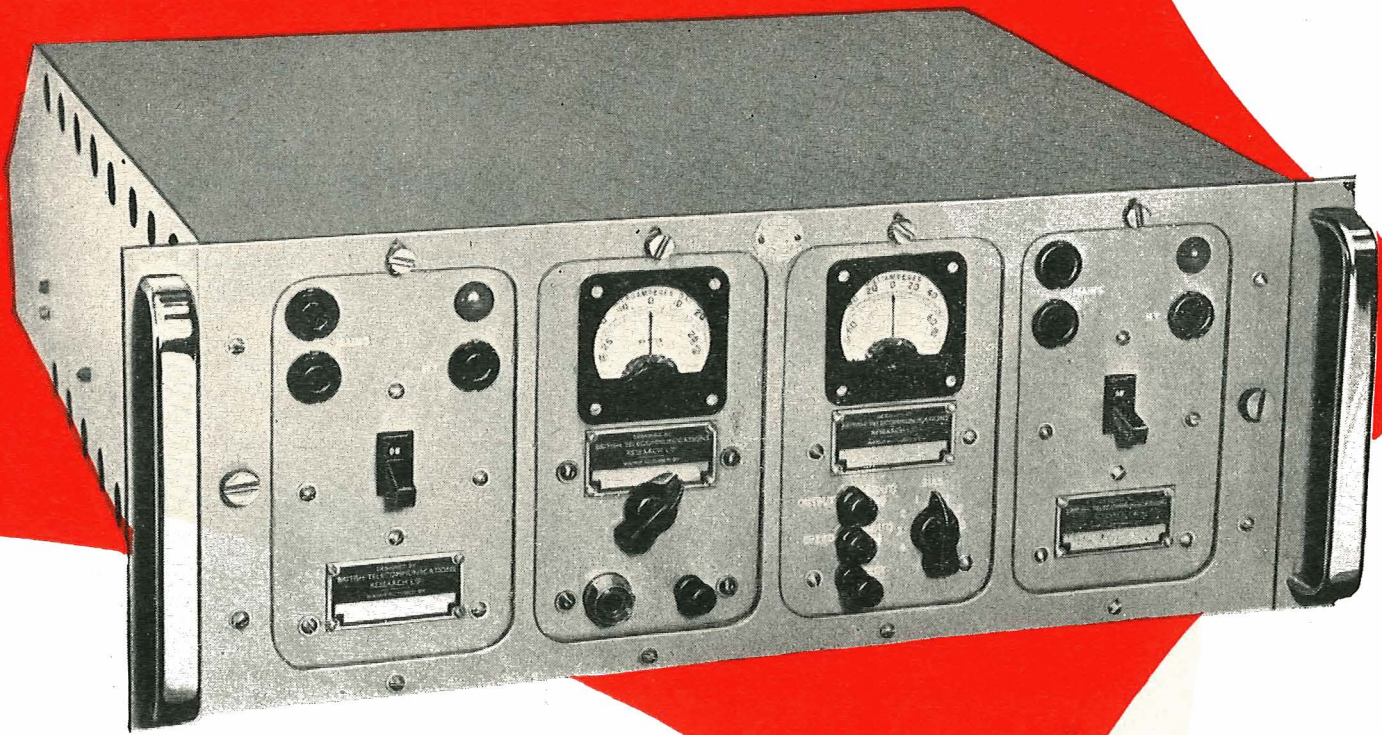

The unit illustrated is a single receiver converter: dual or triple-diversity converters can also be supplied. All can be worked on bandwidths from 10 to 200 cps. In addition, plug-in discriminators have been developed, which enable the equipment to be used on orthodox wide shift F.S. circuits.

Pilot Carrier

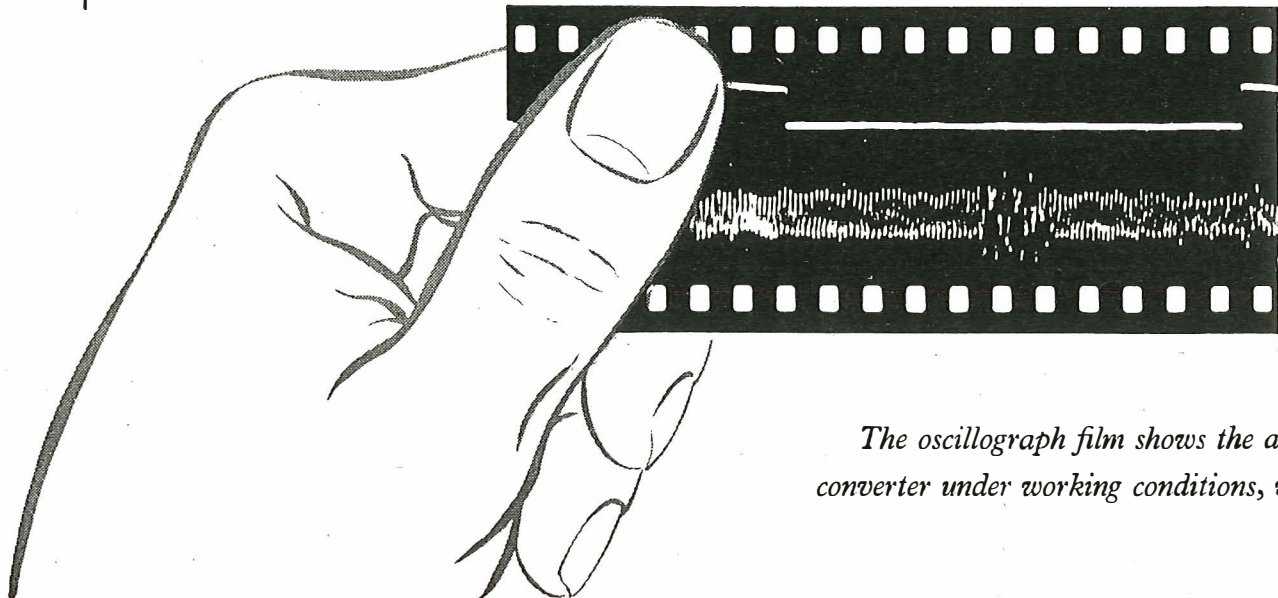

The oscillograph film shows the a converter under working conditions, :

Telephone: TEMple Bar 9262
Cablegrams: STROWGEREX · LONDON



AUTOMATIC TELEPHONE

* *Reduces errors by a ratio of 4:1*

* *Is unaffected by fading of as much as 85 db*

* *Is unaffected by receiver frequency drift*

Working on an exceptionally narrow bandwidth of only 50 cps, instead of the conventional 850 cps, the new P.C.F.S. equipment operates with unprecedented efficiency despite high noise and interference levels. On live circuit operation, errors are reduced by a ratio of 4:1, whilst fading of as much as 85 db has no effect on reception.

NARROW BAND

Frequency Shift Equipment

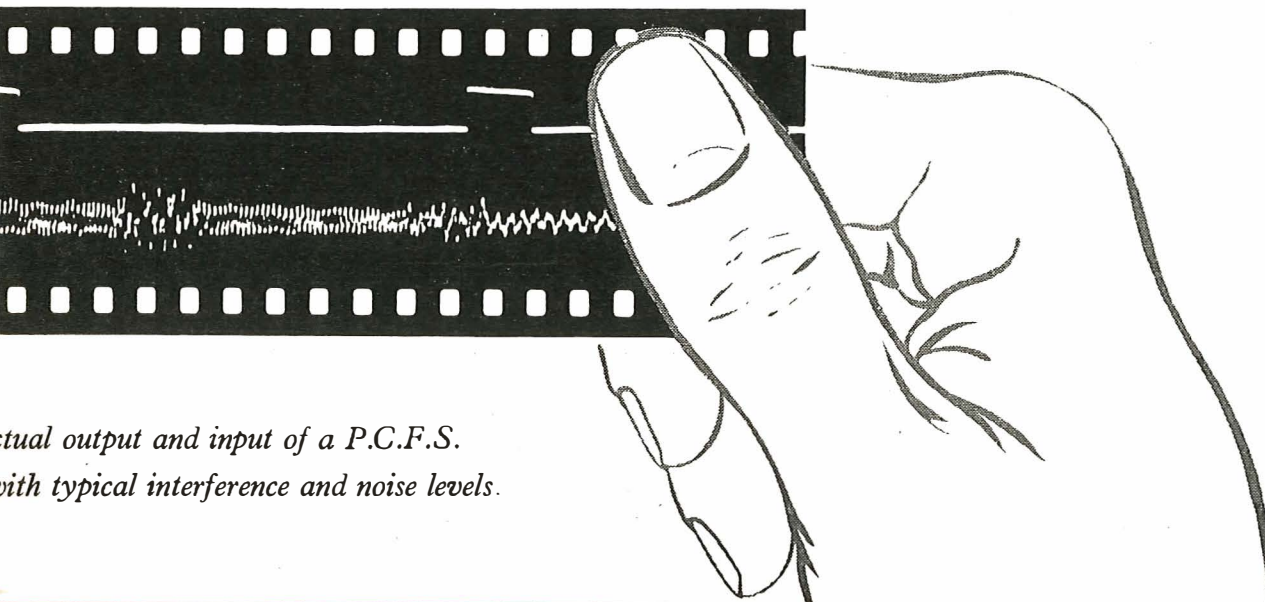

*Actual output and input of a P.C.F.S.
with typical interference and noise levels.*

& ELECTRIC CO. LTD.

**RADIO AND TRANSMISSION DIVISION,
STROWGER HOUSE, ARUNDEL STREET, LONDON, W.C.2.**

INLAND CABLE-LAYING EQUIPMENT BY GIBBINS

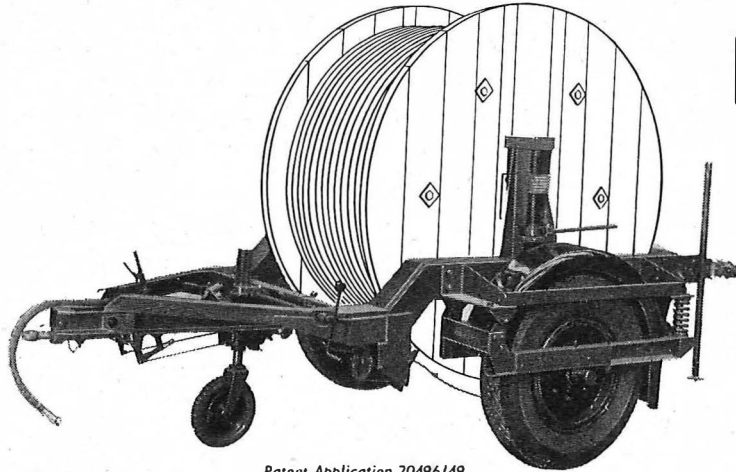

Patent Application 20496/49
(U.K. and Abroad)

'PILOT' CABLE DRUM TRAILER

Always, the large type of cable drum has presented a handling problem. The drums are heavy, and awkward things to transport and manoeuvre. By means of the 'PILOT' cable drum trailer cable drums from 14 cwt. to 4 tons in weight can be lifted, mounted on the trailer, transported and manoeuvred into the position from which the cable is to be paid out, quickly and easily, without manual effort, and without the aid of lifting gear.

The trailer can accommodate drums of 3' to 7' 6" diameter and up to 3' 8" in width. A cable drum is raised from the ground and mounted in position by means of ratchet-operated jacks which are an integral component of the trailer chassis.

(The photographs reproduced here are by courtesy of the Postmaster General.)

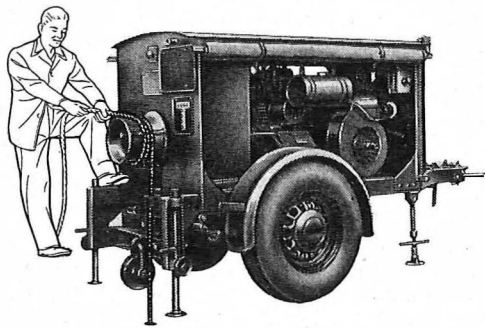

'PILOT' POWER
PULLING WINCH

'PILOT' POWER PULLING WINCH

This winch provides power-assisted haulage and its capacity, operating through a warping bollard is at low speed $2\frac{1}{2}$ tons and at high speed $\frac{3}{4}$ ton. Fuel consumption is $4\frac{1}{2}$ pints/hr. at full load. The design takes into account the heavy usage to which such equipment is generally subjected.

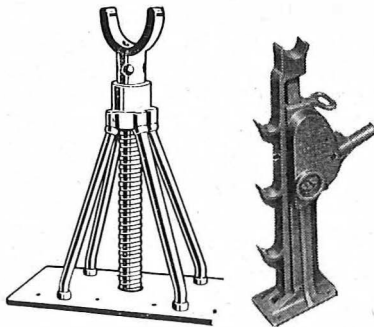

CABLE DRUM
JACKS

CABLE DRUM JACKS

Despite the advent of the 'PILOT' cable drum trailer, a set of jacks should always be carried in inland cable-laying, repair or maintenance operations. We supply screw-type jacks to lift up to 20 tons and ratchet-types to lift up to 5 tons.

We also supply Pole Jacks, another essential item in a cable laying contractor's kit, which exert a pull of 5 tons.

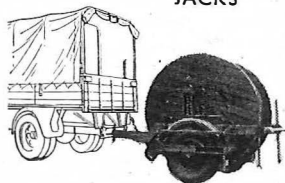

Illustrated literature is available for these various items of inland cable-laying equipment and will be sent to you on request.

Please address enquiries to:—**RICHARD C. GIBBINS & Co. Ltd.**
43 Berkley Street, BIRMINGHAM, 1
Telephone: Midland 6183/4



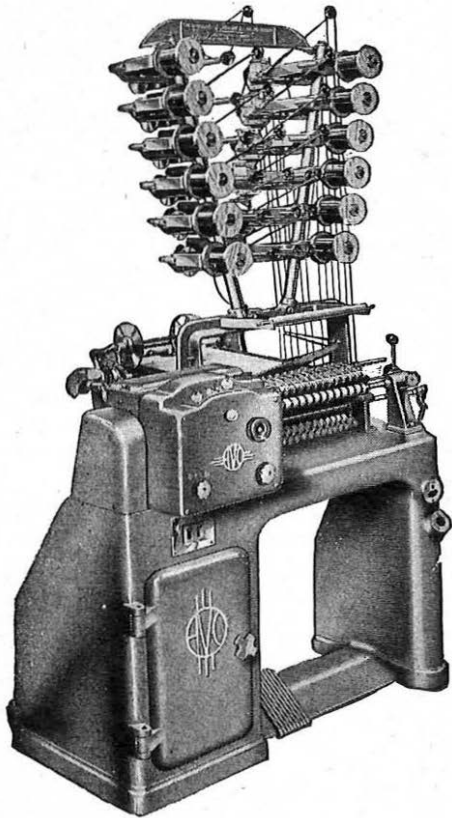

DOUGLAS AND MACADIE

Automatic
COIL WINDERS

The large illustration depicts the improved "Douglas" Fully Automatic Multi-Winder, specially developed for the high speed production of large quantities of coils with or without paper interleaving. It will produce round, square

or rectangular coils up to 6 in. each in length and up to 4½ in. diameter. As many as 12 smaller coils can be wound simultaneously within the total available winding length of 15 in. at headstock speeds of between 600 and 2,000 r.p.m.

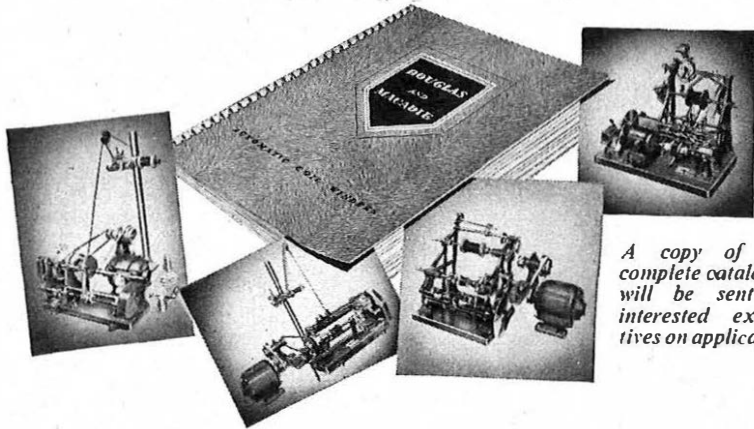

A copy of our complete catalogue will be sent to interested executives on application

Sole Proprietors and Manufacturers

THE AUTOMATIC COIL WINDER & ELECTRICAL EQUIPMENT CO., LTD

Avocet House, 92-96 Vauxhall Bridge Road, London, S.W.1

Victoria 3404 (9 lines)

Z1/PZ/ZWS



OSCILLATOR *Type 858*
30 kc/s - 30 Mc/s

THE Oscillator Type 858 is a general purpose CW oscillator with special characteristics of very low harmonic distortion, high frequency stability and constant output level. These features make it particularly suitable for use as a calibrating oscillator.

Three standard output levels are available from separate sockets, and the incorporation of a variable control enables any output between 0.5 mV and 0.5 volts to be obtained.

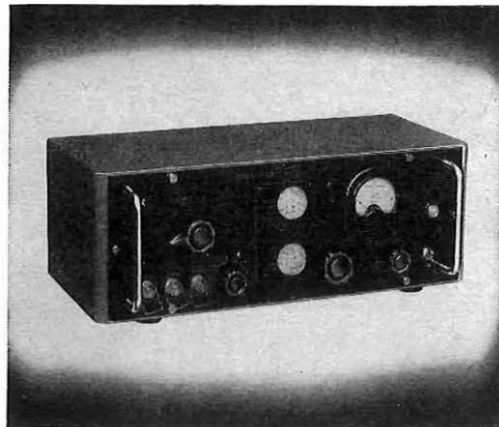

FREQUENCY RANGE:

30 kc/s-30 Mc/s in 7 ranges

FREQUENCY STABILITY:

Considerably better than 0.05 per cent. with mains change from 200-250 V

HARMONIC DISTORTION:

In general, less than 1 per cent.

OUTPUT LEVEL:

Remains constant within ± 1db over complete frequency range

OUTPUTS:

500 mV, 100 mV and 10mV standard. A slidewire attenuator enables a continuous output coverage to be obtained from 500 μV to 500 mV

DIMENSIONS:

The instrument which is suitable for both bench use and forward rack mounting is 19 in. wide, 7 in. high and 10 in. deep (over projections)

Full details of this or any other Airmec instrument will be forwarded gladly upon request

AIRMEC
L I M I T E D

HIGH WYCOMBE BUCKINGHAMSHIRE ENGLAND

Telephone: High Wycombe 2060.

Cables: Airmec, High Wycombe.

CARPENTER

POLARIZED RELAYS

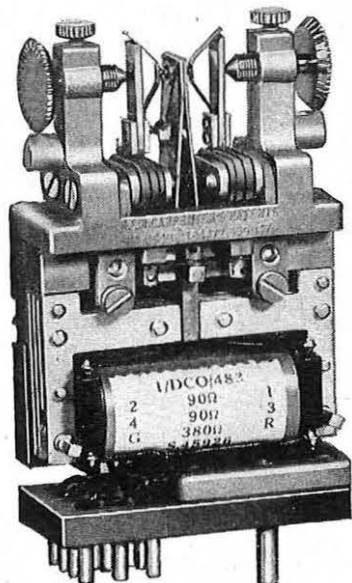

have these outstanding features

- HIGH OPERATIONAL SPEED • HIGH SENSITIVITY
- FREEDOM FROM CONTACT REBOUND
- NO POSITIONAL ERROR • HIGH CONTACT PRESSURES
- ACCURACY OF SIGNAL REPETITION
- EASE OF ADJUSTMENT

The Carpenter Polarized Relay will respond to weak, ill-defined or short-duration impulses of differing polarity, or it will follow weak alternating current inputs of high frequencies and so provide a continuously operating symmetrical changeover switch between two different sources.

Dimensionally the Type 4 relay illustrated is interchangeable with the type "3000" Relay and can be supplied to fit directly to the drilling normally provided for the "3000" Relay.

Manufactured by the sole licensees

TELEPHONE MANUFACTURING CO. LTD

Contractors to Governments of the British Commonwealth and other Nations



HOLLINGSWORTH WORKS, DULWICH, LONDON, SE21

Telephone GIPsy Hill 2211

IMPROVEMENT IN THE ACCURACY OF DECADE RESISTANCES

We have pleasure to announce that the well-known and novel

SULLIVAN and GRIFFITHS

DUAL DIAL DECADE RESISTANCE BOXES

FOR ALL FREQUENCIES

Moreover, the windings are now of Manganin in order to reduce the temperature coefficient; more important still, to improve the long period of stability and make them as suitable for all direct-current purposes as they are for alternating currents of all frequencies.

Screened Resistances of guaranteed accuracy exactly similar to our well-known Decade Resistances but specially arranged so that one box of a given number of dials gives many different values of maximum resistance. Thus a three-dial box (as illustrated) may be used for instance for

- | | |
|---|-------------------------|
| three decades of Thousands, Hundreds and Tens | a total of 10,000 ohms. |
| or three decades of Hundreds, Tens and Units | a total of 1,000 ohms. |
| or three decades of Tens, Units and Tenths | a total of 100 ohms. |
| or three decades of Units, Tenths and Hundredths, | a total of 10 ohms. |

have now been improved in accuracy to

0.05 PER CENT

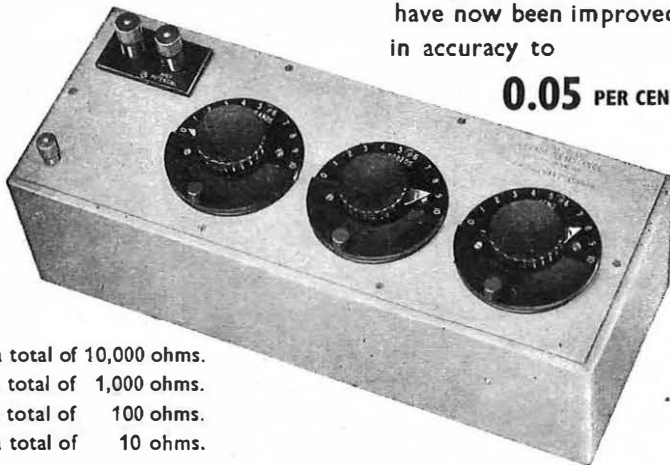

H. W. SULLIVAN LIMITED

LONDON, S.E.15

Telephone: New Cross 3225 (P.B.X.)

The advantages of such a system will be obvious, for in addition to the economy involved much space is saved and the residual resistance and inductance is much reduced.

The resistances are available in 3-dial, 4-dial and 5-dial types with subdivision of 0.001% down to 0.001 ohm if necessary, depending of course on the number of dials incorporated.



BARRETTETTER XBI

The Hivac miniature BARRETTETTER XBI maintains a steady current of 0.3 Amps over a range of 9 to 16 Volts. It is intended to stabilize the heater circuits of valves under conditions of fluctuating supply voltages.

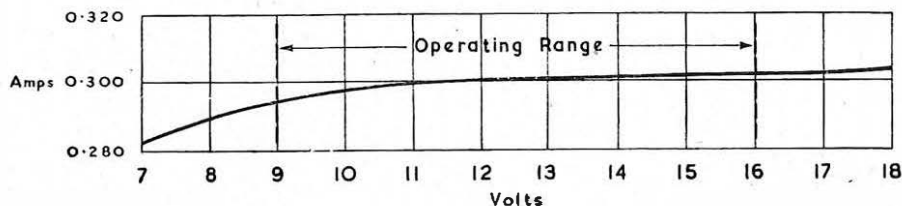

Hivac Limited

STONEFIELD WAY, VICTORIA ROAD, SOUTH RUISLIP, MIDDLESEX
Telephone: Ruislip 3366



DC Voltage limits $\pm 1\%$ despite:—

- * AC voltage fluctuations of -10 to $+6\%$.
- * Frequency variations of 48 to 52 cps.
- * Load variations of 5% to 100% and self-protecting on overload.

The above are typical limits of our range of constant DC voltage equipments. Electronic, magnetic or mechanically regulated equipments are available and can also be designed to meet customers' specific requirements. Consult us for the most satisfactory solution to your problems—take full advantage of the WESTINGHOUSE SERVICE.



CONSTANT POTENTIAL RECTIFIERS

Write for details to:—

Dept. P.O.I, WESTINGHOUSE BRAKE & SIGNAL CO. LTD., 82 York Way, King's Cross, London, N.1
Telephone:— TBRminus 6432

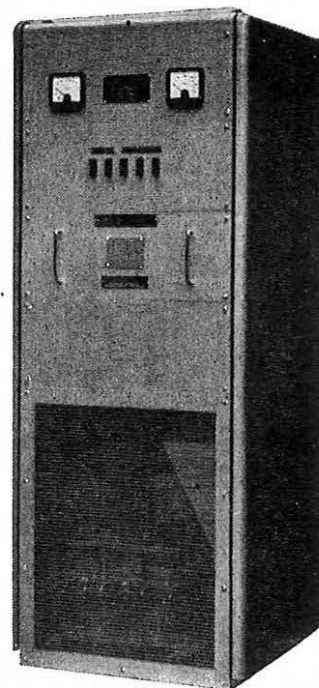

Typical Transbooster

Pye Telecommunications announce a **NEW TWO-WAY RADIO EQUIPMENT**

Demonstrations of a new equipment, designed in Cambridge, have been given in London recently to representatives of Police and Fire Services, Local Authorities and Industrial Organisations. This equipment has been designed to defeat the chronic shortage of two-way radio channels.

Known as the Pye "Ranger" it is the solution to the frequency shortage which is hamstringing mobile radio users in Great Britain!

The new equipment operates on a channel spacing of only 25Kc/s—a quarter of the customary spacing—thus potentially quadrupling the number of mobile radio channels. Robust construction, excellent performance and carefully selected components make it capable of operating under arduous conditions and in any weather.

This mobile radio is designed for fitting in the dashboard of ordinary cars and vehicles. The price of the equipment, notwithstanding its many-times improved specification, is approximately the same as that of earlier equipments which it now replaces.

Please write for full details



PYE TELECOMMUNICATIONS LTD., NEWMARKET ROAD, CAMBRIDGE. TELEPHONE: TEVERSHAM 3131

HACKBRIDGE CABLES



FOR ALL PURPOSES

Contractors to the

G.P.O. — NATIONAL COAL BOARD — BRITISH RAILWAYS.
C.E.A. and BRITISH & DOMINION GOVERNMENT DEPTS.

HACKBRIDGE CABLE CO. LTD.

KELVIN WORKS — HACKBRIDGE — SURREY

In Association with BRYCE ELECTRIC CONSTRUCTION COMPANY LTD.

TELEPHONE DISTRIBUTION

EQUIPMENT

ENGINEERS WHO ARE INTERESTED
IN TELEPHONE DISTRIBUTION EQUIP-
MENT ARE INVITED TO REQUEST
SECTION T.C.13 OF OUR TELECOM-
MUNICATION CABLES CATALOGUE.

TELEPHONE:
SOUTHAMPTON
22141 (5 lines).

PIRELLI GENERAL
CABLE WORKS, Ltd., SOUTHAMPTON

TELEGRAMS
"PIGEKAYBEL
SOUTHAMPTON"



PRECISION MONITOR



*Photograph
by courtesy of
the B.B.C.*

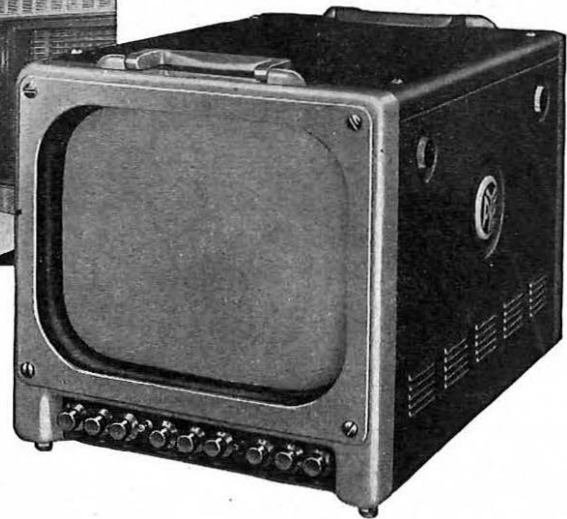

FEATURES

- ★ Built to an exacting specification as a precision video monitor and designed for either studio or field use.
- ★ Extra bright pictures are produced on a 14-inch (36 cm.) straight gun cathode ray tube specially designed for high quality pictures.
- ★ Wide frequency response to enable the monitor to be used for picture quality checks.
- ★ Will operate on either a composite signal or separate video and synchronising waveforms.
- ★ Separate heater and power transformers with dual primary windings to cover wide range of a.c. power input voltages.
- ★ Design incorporates stabilised B+ supply and a 14 kV regulated high voltage system for the cathode ray tube.
- ★ Optional use of either a d.c. restorer or a black level clamp by means of internal plug and socket selector switch.
- ★ All picture controls are arranged on the front recessed panel.
- ★ Front panel controls for d.c. operated vertical and horizontal picture shift circuits.
- ★ Provided with easily removable top, bottom and side panels to facilitate maintenance.
- ★ Silent extractor fan on rear panel ensures stable temperatures during long periods of operation.
- ★ Mobile adjustable stand, waterproof hood, and rack mounting attachment available as accessories.

*PYE are supplying 200 of
these Monitors to the B.B.C.*

Other customers include:

Ministry of Works

The G.P.O.

High Definition Films Ltd.

Bristol Aeroplane Co.

U.K. Atomic Energy Authority

Associated Broadcasting Co.

Associated Rediffusion Ltd.

Granada TV Network Ltd.

Independent Television Authority

P Y E L I M I T E D · C A M B R I D G E · E N G L A N D

Pye (New Zealand) Ltd.,
Auckland C.I., New Zealand.

Pye Canada Ltd.,
Ajax, Canada.

Pye Pty. Ltd.,
Melbourne, Australia.

Pye (Ireland) Ltd.,
Dublin, Eire.

Pye Radio & Television (Pty) Ltd.,
Johannesburg,
S. Africa.

Pye Limited,
Mexico City.

Pye Limited,
Tucuman 829,
Buenos Aires,
Argentina

Pye Corporation of America,
270, Park Avenue,
New York.

Cables: Pyetelecom, Cambridge

Telephone: Teversham 3131



The

DETECTOR No. 4 Mk. 10

—a TURNER instrument produced for Post Office engineers and combining a high level of sensitivity with accuracy and robust design for work in the field.

ERNEST TURNER ELECTRICAL INSTRUMENTS LTD.

HIGH WYCOMBE BUCKS ENGLAND

Telephone: HIGH WYCOMBE 1301-2.3

Telegrams: GORGEOUS, HIGH WYCOMBE

for the right connection

ANACOS
REGD.

telephone line wire

FREDERICK SMITH & COMPANY
ANACONDA WORKS, SALFORD, 3, LANCS.
Incorporated in The London Electric Wire Company and Smiths Limited.
Associated with The Liverpool Electric Cable Co. Ltd. and Vactite Wire Co. Ltd.

FREE! *to YOU! —if you seek SUCCESS!*

If you lack qualifications which would get you a better job, more pay and faster progress; if you really want to succeed in your studies for the City & Guilds Certificates . . . send now for this recently published, important book —“Train your Mind to SUCCESS.”

HERE is the amazing story of The Famous Bennett College, its awards, scholarships, medals. Read what eminent educationists have to say about Personal Postal Tuition—The Bennett College way!

READ actual cases taken from its half a million success stories —from Bricklayer to Assistant Manager, from Draughtsman to Director—and many others!

SEE how you will learn when you enrol—how your own personal tutor watches over every step of your progress—how your success is *guaranteed*. **POST THIS COUPON NOW!**

“I GUARANTEE TUITION UNTIL YOU HAVE PASSED”

Preliminary Course
Telecommunications
Principles I - V
Radio I - IV
Telegraphy I & II
Line Transmission I & II
Mathematics for Telecommunications
Radio Servicing Certificate

BENNETT COLLEGE
(DEPT. A.24.F.), SHEFFIELD

Please send me, without obligation, a free copy of “Train your mind to SUCCESS” and the College Prospectus on:

SUBJECT _____
NAME _____
ADDRESS _____
AGE (if under 21) _____

Please write in Black Letters

THIS DAY COULD BE THE TURNING-POINT IN YOUR LIFE.

THIS COUPON COULD BE YOUR PERSONAL PASSPORT TO SUCCESS. *Send it NOW!*

EDISWAN

Telephone Line Protectors

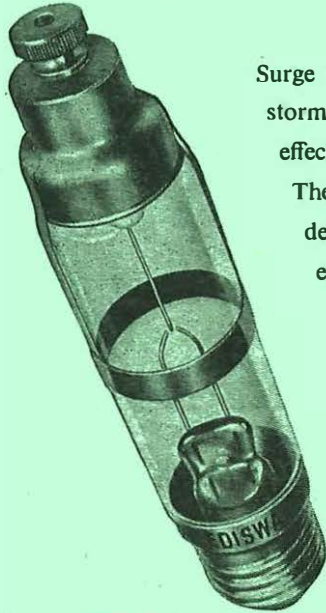

Surge currents induced on telephone lines by electric storms or breakdowns on neighbouring power lines may be effectively controlled by Ediswan telephone line protectors.

These special electrode gas discharge tubes have been developed in collaboration with G.P.O. Engineers to provide economical and effective protection for telephone systems without impairing the service.

Full details of these protectors and their application is given in the Ediswan publication C.1581 which is available on application.

THE EDISON SWAN ELECTRIC CO., LTD.

155 CHARING CROSS ROAD, LONDON, W.C.2

Member of the A.E.I. Group of Companies

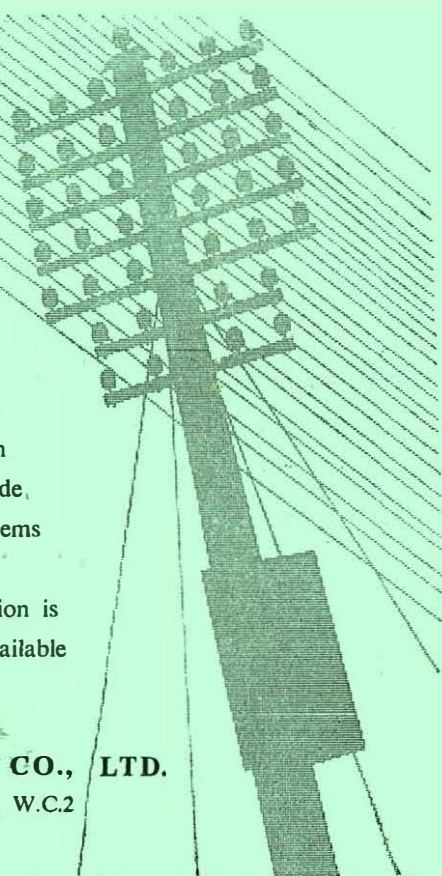

TE107

THIS INTERESTING QUARTERLY WILL BE MAILED FREE TO ANY PART OF THE WORLD

For almost a century Muirhead & Co. Limited have manufactured precision electrical instruments, and to-day the range of products include measuring instruments for education and industry, synchros and remote control systems and facsimile transmitters and recorders.

Each issue of "Technique" contains details of the newest Muirhead products and of scientific developments in which Muirhead instruments have played an important part. If you think this publication would interest you, we shall be pleased to place your name on our mailing list. Write under your business letterhead to the address given below.

MUIRHEAD

PRECISION ELECTRICAL INSTRUMENTS

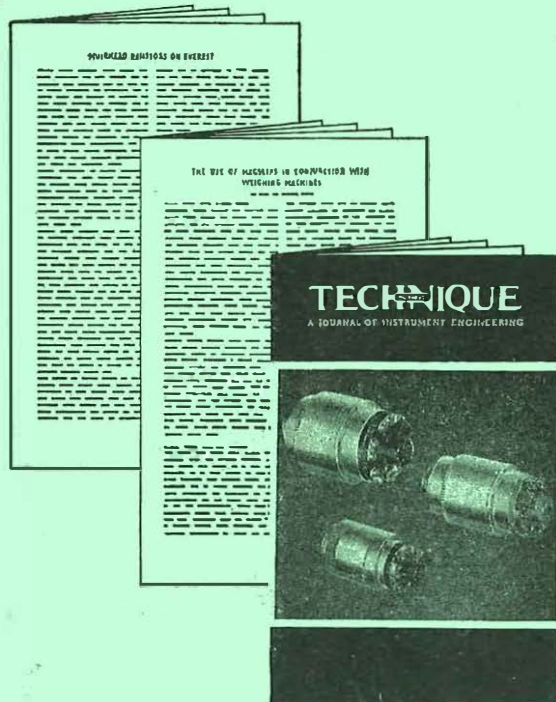

136

MUIRHEAD & CO. LIMITED • BECKENHAM • KENT • ENGLAND