

# THE POST OFFICE ELECTRICAL ENGINEERS' JOURNAL

**VOL. 39**

**OCTOBER, 1946**

**PART 3**

## CONTENTS

	PAGE
UNIT TYPE CABLE FOR SUBSCRIBERS' DISTRIBUTION SCHEMES—R. E. Taylor .. .. .	81
EXTENSION OF DIALLING-OUT FACILITIES IN THE LIVERPOOL DIRECTOR AUTOMATIC AREA—F. M. McDougald, A.M.I.E.E., and E. L. Perkins .. .. .	85
THE RESTORATION OF THE ANGLO-FRENCH TELEPHONE SERVICE, 1944-1945—J. C. Billen .. .. .	90
A SIMPLIFIED CABLE BALANCING INSTRUMENT—Part 2—Use of the Instrument in the Field—H. C. S. Hayes, A.M.I.E.E., and E. D. Latimer .. .. .	96
FLEXIBILITY UNITS FOR LOCAL LINE NETWORKS—Part 1—Pillars, Cabinets and Combined Units—J. J. Edwards, B.Sc.(Eng.), D.I.C., A.M.I.E.E., and J. P. Harding, B.Sc.(Eng.), A.M.I.E.E.	100
THE EXTENSION OF 2 V.F. TRUNK DIALLING FACILITIES—B. R. Horsfield, A.M.I.E.E., and G. R. Campbell .. .. .	105
SATURABLE CHOKE CONTROLLED RECTIFIERS—H. S. Double, B.Sc.(Eng.), A.M.I.E.E. .. .. .	110
HOW NEGATIVE FEEDBACK OPERATES—C. A. A. Wass, B.Sc., A.M.I.E.E., A.Inst.P. .. .. .	114
COMITÉ CONSULTATIF INTERNATIONAL TÉLÉPHONIQUE MEETINGS IN PARIS, JUNE AND JULY, 1946 .. .. .	117
NOTES AND COMMENTS .. .. .	119
REGIONAL NOTES .. .. .	123
INSTITUTION OF POST OFFICE ELECTRICAL ENGINEERS	124
JUNIOR SECTION NOTES .. .. .	125
BOOK REVIEWS .. .. .	109, 113, 126
STAFF CHANGES .. .. .	127

Price 1/- net

**THE INSTITUTION OF POST OFFICE ELECTRICAL ENGINEERS**

# GE CALLOY RADIO CORES

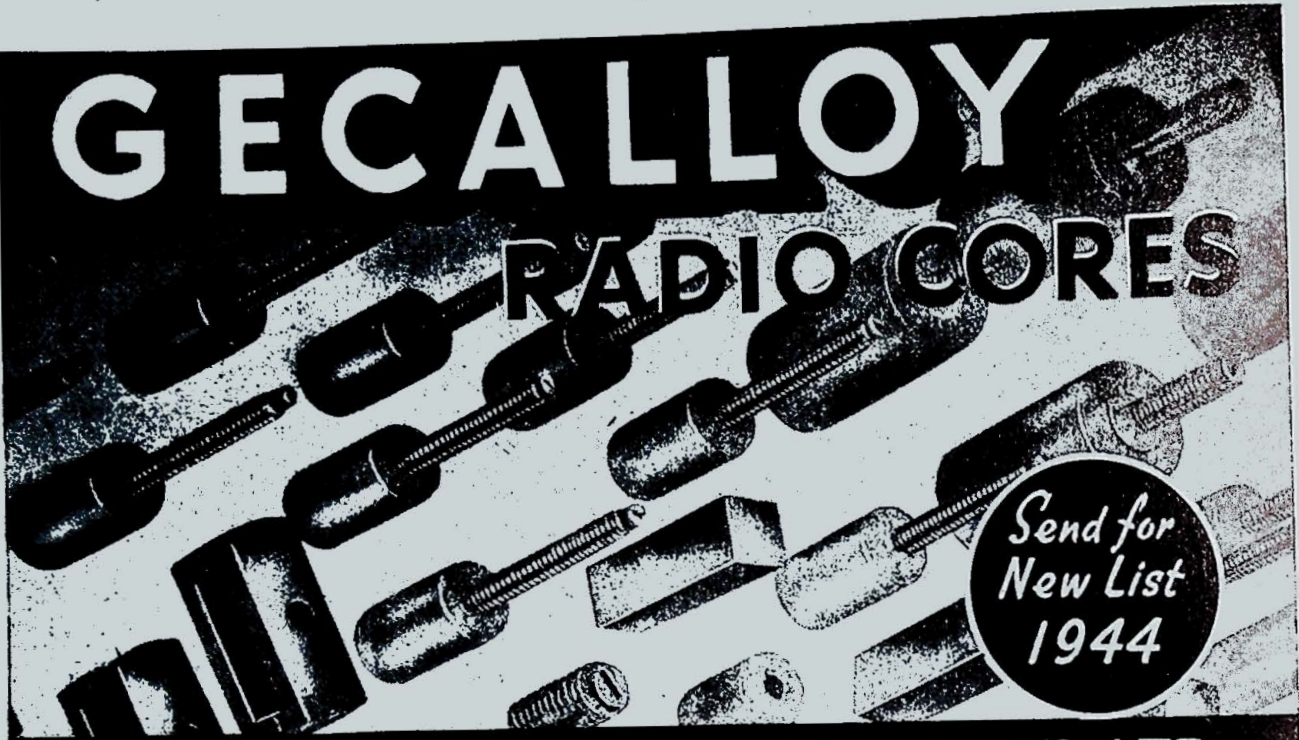

Send for  
New List  
1944

**SALFORD ELECTRICAL INSTRUMENTS LTD.**  
PEEL WORKS, SALFORD, 3. Telephones : BLAckfriars 6688 (6 lines). Telegrams and Cables : "Sparkless, Manchester"  
PROPRIETORS: THE GENERAL ELECTRIC Co. Ltd., OF ENGLAND

# EDISWAN

## TELEPHONE LINE PROTECTOR PANELS

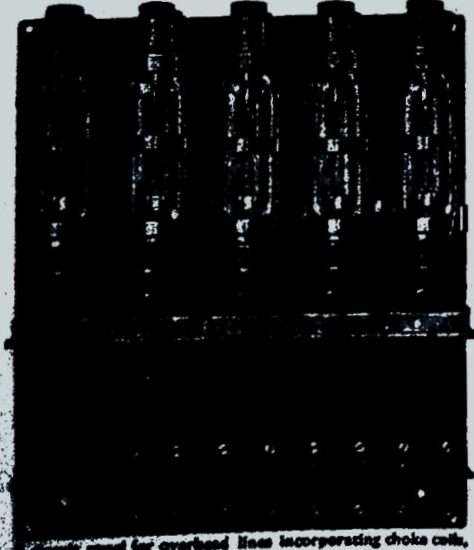

EDISWAN-SHOTTER-GREETHAM PATENT (British Patent No. 353924)

for the protection of telephone systems against surges induced by faults on neighbouring power lines

Of the difficulties attendant upon the employment of overhead systems one of the most serious is to ensure uninterrupted working of the telephone system, by providing adequate protection against induced surges caused by switching or line faults in adjacent power lines or by lightning.

The Ediswan Patent Protectors provide the solution. They are inert at the normal working pressure of the telephone line, they keep the voltage on the line down to a pre-determined figure by providing a path of low resistance to earth whereby the surge is cleared and they again become inert immediately the surge is cleared.

They ensure simultaneous discharge of both lines and are capable of clearing heavy discharges without detriment to the system or the protector.

Ediswan Telephone Line Protectors have now been in use by Supply Companies for many years.

Special panel for overhead lines incorporating choke coils, spark gaps, etc.

THE EDISON SWAN ELECTRIC CO. LTD., 155 CHARING CROSS ROAD, LONDON, W.C.2

# THE POST OFFICE ELECTRICAL ENGINEERS' JOURNAL

Vol. XXXIX

October, 1946

Part 3

## Unit Type Cable for Subscribers' Distribution Schemes

R. E. TAYLOR

U.D.C. 621.315.213 621.395.74

The author describes the general features of the unit type pair cable which has not previously been used in this country, and gives some details of modifications which have been introduced for Post Office use.

### Introduction.

UNIT type pair cable has now been in use for several years in America and some countries on the Continent for subscribers' distribution schemes. For ease of jointing, especially on multiplying schemes,<sup>1</sup> and because its electrical characteristics are so good, the unit type of pair cable has several advantages to offer over the standard types of cable at present used by the British Post Office for similar work. However, as the means of identification of pairs was inadequate for Post Office requirements, a similar type of cable, with considerable modification to the colour scheme, has been introduced on an experimental basis, and has been given an extensive field trial. It is intended to describe the unit type cable in some detail, and compare its electrical characteristics and some economic considerations with those of the standard P.C.Q.L. and P.C.T. types of cable which have so far been used for subscribers' distribution work in this country. Some of the results obtained on a field trial of the Post Office type of unit cable are also given.

### American Type of Unit Cable.

The cable consists of units containing 101 pairs (or 51 pairs in the smaller cables), and a number of these units is stranded together to form the complete cable. Each unit is made of pairs of wires twinned together, having the paper insulation (which is made of paper pulp) on one wire coloured and on the other white (i.e. neutral). The colours used to distinguish between units are red, green, and blue, as indicated in Fig. 1. The pairs are laid up in layers which all have the same direction of lay, and there is thus a considerable degree of flexibility enabling the units to take up whatever shape of cross-section is necessary. An open lapping of coloured cotton is applied

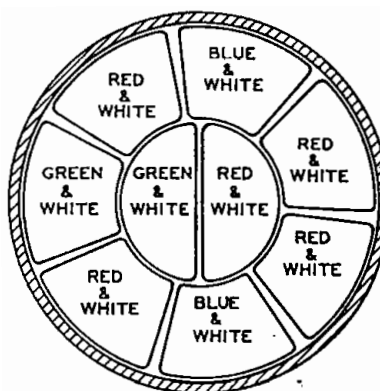

OUTSIDE UNITS LAPPED WITH ORANGE AND GREEN COTTON. INSIDE UNITS LAPPED WITH ORANGE COTTON.

FIG. 1.—909-PAIR AMERICAN TYPE UNIT CABLE (½ LB.).

to each unit, the colour indicating the gauge of conductor used.

One pair, known as a "tracer," having the insulating paper on one wire coloured red, and on the other wire blue, can be definitely identified in each

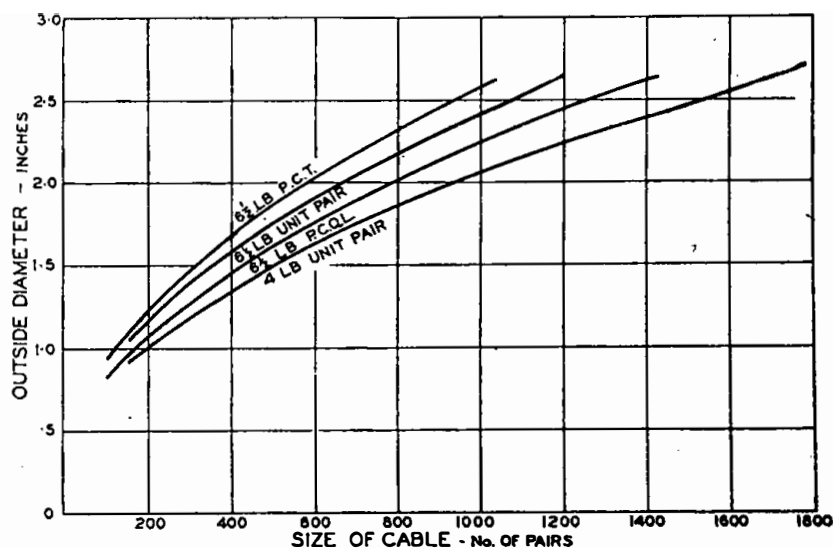

FIG. 2.—COMPARISON OF OUTSIDE DIAMETERS OF UNIT PAIR, P.C.T. AND P.C.Q.L. CABLES.

<sup>1</sup> I.P.O.E.E. Printed Paper No. 180.

unit, but other pairs, particularly those in the centre, cannot be identified. Tests on samples of this type of cable indicated that it is not uncommon for pairs in a drum length to be misplaced out of layer, probably because there are no lappings between layers. Six to eight per cent. of the pairs in the lengths tested were misplaced, and this, besides being liable to cause high crosstalk, is sufficient to make straight jointing of this type of cable impracticable. (It is understood that in America the pairs are jointed in a random manner within a unit and tapped out from the exchange to teed joints, etc., as required.) As all the pairs in a unit, except one, have the same markings, discrimination between wires with the same colour insulation, in adjacent pairs, is rather difficult, and there may be a chance of splitting pairs during jointing.

The cable is available with conductors of 2½, 4, 6½ and 10 lb. per mile, and for equal gauge of conductor is somewhat larger in overall diameter than P.C.Q.L. type of cable containing the same number of pairs. A comparison between the outside diameters of American type of unit pair cable (applicable also to the experimental Post Office type described later) and the standard P.C.Q.L. and P.C.T. types of cable is shown in Fig. 2. It will be seen that unit cable, although less economical in duct space than P.C.Q.L. is better than P.C.T. As a result of the different make-up of unit cable, its mutual electrostatic capacitance is higher than that of P.C.Q.L. or P.C.T. types of cable. The specified maximum values of M.E.C. for 6½ lb. P.C.Q.L., P.C.T., and Post Office type of unit cable are .075, .075 and .085 μF respectively.

The possibility of using 4 lb. conductors is important, as there are some exchange areas where 4 lb. cable might be used instead of 6½ lb., the smallest size so far used in this country. As shown in Fig. 2, 4 lb. unit type cable is more economical in duct space than 6½ lb. P.C.Q.L., it being possible to draw an 1,800 pair 4 lb. cable into a standard 3½ in. duct.

Although the colour scheme used does not permit of the ready identification of pairs for straight jointing, the general principle of the unit type of construction makes the jointing of large cables easier than with the standard P.C.Q.L. type of cable. For instance, only one unit need be prepared for jointing at one time (so helping to maintain the insulation up to standard). Also, when it is necessary to tee off 50 pairs at a distribution pillar, or a hundred pairs at a cabinet,<sup>2</sup> it is much easier to bring out one or more units complete than 25 or more quads out of a quad cable, with the probable splitting of layers, and complications due to the odd sizes of present cables.

The electrical characteristics measured on a drum length of unit cable compare favourably with those of P.C.Q.L. cables. The average capacitance un-

<sup>2</sup> I.P.O.E.E. Printed Paper No. 180

balance between adjacent pairs on the two drum lengths tested was only about 14 μμF, and between non-adjacent pairs was less than 5 μμF. The maximum value measured was 140 μμF (between adjacent pairs). Typical mean values obtained on 176 yard lengths of P.C.Q.L. cable are 74 μμF between pairs in the same quad, and 34 μμF between pairs in adjacent quads, with a maximum of 430 μμF between pairs in the same quad. Some representative figures for capacitance unbalance are given in Table 1.

TABLE 1  
PAIR TO PAIR CAPACITANCE UNBALANCE ON UNIT AND P.C.Q.L. TYPE CABLES  
(CORRECTED TO 176 YARDS).

	Adjacent Pairs μμF		Non-adjacent Pairs. No. of Cases equal to or greater than, μμF						
	Max.	Mean	5	10	15	20	30	40	50
4 lb. American type of unit cable (404 pr.)									
Within layer, centre	14	9	3	1	1	—	—	—	—
Within layer, 1	—	—	12	5	—	—	—	—	—
Within layer, 2	19	6	24	7	—	—	—	—	—
Within layer, 3	131	18	43	18	6	—	—	—	—
Within layer, 4	51	9	45	10	1	—	—	—	—
Within layer, 5	61	9	89	28	12	8	4	3	2 cases of 65 & 50 μμF
6½ lb. Post Office type of unit cable (909 pr.)*									
Within layer, centre	49	21	—	—	—	—	—	—	—
Within layer, 1	12	6	2	—	—	—	—	—	—
Within layer, 2	36	19	4	1	—	—	—	—	—
Within layer, 3	36	12	6	—	—	—	—	—	—
Within layer, 4	43	11	6	—	—	—	—	—	—
Within layer, 5	36	13	9	—	—	—	—	—	—
6½ lb. P.C.Q.L. (average values on several sizes of cable)									
Between pairs in the same quad	430	74							
Between pairs in adjacent quads	98	34							

\* Initial supplies had 101 pairs per unit.

Since crosstalk is a function of capacitance unbalance, the adoption of unit type pair cable would produce a considerable improvement in the general level of crosstalk on the subscribers' cable networks.

Figs. 3 and 4 show curves of the characteristic impedance and attenuation for the 4 lb. American type and for the 6½ lb. Post Office type of unit cable.

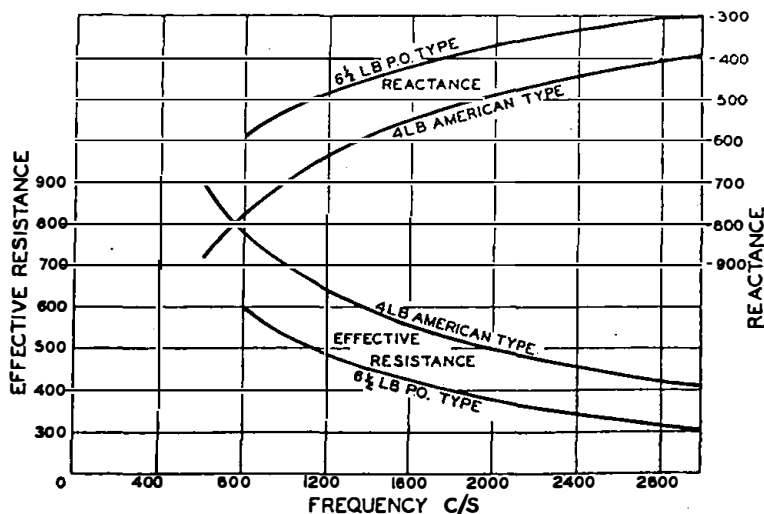

FIG. 3.—IMPEDANCE/FREQUENCY CHARACTERISTICS OF AMERICAN AND POST OFFICE TYPES OF UNIT CABLE.

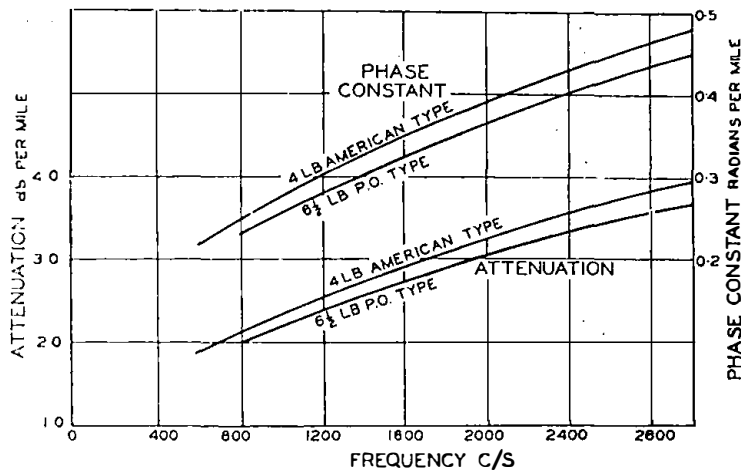

FIG. 4. ATTENUATION AND PHASE CONSTANT CHARACTERISTICS OF AMERICAN AND POST OFFICE TYPES OF UNIT CABLE.

*Post Office Experimental Unit Type Pair Cable.*

For use by the Post Office it has been decided that the balance of advantage lies in unit type cable having a colour scheme which enables any pair in the cable to be readily identified, so that :-

- (a) Tests can easily be made on all wires during inspection at the manufacturer's works, and faults thus found quoted on a label attached to the cable drum.
- (b) A cable which becomes faulty after installation can be changed over in colour rotation.

TABLE 2

MAKE-UP OF COMPLETE CABLES (4 LB., WHEN AVAILABLE, 6 1/2 LB., AND 10 LB.)

Number of Pairs in Cable		Number of Pairs in Unit	Total number of Units	Lay up of Units in Cable		
Nominal	Actual			Centre	1st Layer	2nd Layer
10	10	10	1	—	—	
15	15	15	1	—	—	
20	20	20	1	—	—	
30	30	30	1	—	—	
50	51	51	1	—	—	
75	76	76	1	—	—	
100	102	51	2	—	—	
150	153	51	3	—	—	
200	204	51	4	—	—	
300	306	51	6	—	—	
400	408	102	4	—	—	
600	612	102	6	—	—	
800	816	102	8	—	—	
900	918	102	9	—	—	
1000*	1020	102	10	—	—	
1200*	1224	102	12	—	—	
1400†	1428	102	14	—	—	
1800†	1836	102	18	—	—	

\* Only available with 4 lb. or 6 1/2 lb. conductors.  
 † Only available with 4 lb. conductors.

MAKE-UP OF UNITS.

Layer	Number of pairs in unit						
	10	15	20	30	51	76	102
Centre ..	2	1	1	4	1	4	2
1st ..	8	4	6	10	4	10	8
2nd ..	—	10	13	16	10	16	14
3rd ..	—	—	—	—	16	20	20
4th ..	—	—	—	—	20	26	26
5th ..	—	—	—	—	—	—	32

(c) If necessary, the unit type cable can be straight jointed to the present standard type of star-quad cable.

(d) Any chance there may be of splitting pairs during jointing is less than with the American colour scheme.

By incorporating several modifications to the American type of unit cable, the Post Office, in conjunction with the manufacturers, have evolved a type of unit cable which meets the above requirements, besides retaining the advantage of unit construction. A simplification of the manufacturing processes, and an improvement in the electrical characteristics have been achieved at the same time.

In sizes of 100 pairs or above, the cable is made up of several units stranded together to form standard cable sizes, which are shown in Table 2. Round each unit is an open helical lapping of cotton and also a paper tape bearing the number of that unit printed at frequent intervals along its length. The pairs in each unit are stranded together in layers, each with the same direction of lay (except in the small cables mentioned below), to form units of 51 or 102 pairs, and round each layer is a lapping of cotton so that the pairs of one layer are effectively segregated from those of the next. Marker and reference pairs are provided in each layer, and ring wire markings similar to those used on Post Office star-quad cable are employed to distinguish between the A and B wires of pairs. Any pair in a layer can be found by counting round from the marker to the reference pair in the usual manner. It is not difficult to joint it to ordinary star-quad cable if necessary. Table 3 gives details of the colour scheme and Fig. 5

TABLE 3

COLOUR SCHEME OF P.O. TYPE UNIT CABLE

	PAIR	PAIR						
		Marker	2	3	4	5	etc.	Reference
Centre and even layers	Colour of rings	Green	Red	Red	Red	Red	Red	Green
	No. of rings on "A" and "B" wires	1 & 2	1 & 2	3 & 4	1 & 2	3 & 4	etc.	3 & 4
Odd Layers	Colour of rings	Orange	Blue	Blue	Blue	Blue	Blue	Orange
	No. of rings on "A" and "B" wires	1 & 2	1 & 2	3 & 4	1 & 2	3 & 4	etc.	3 & 4

is a photograph of a cable end, clearly showing the unit construction.

The smaller cables, with 76 pairs or less, are made up in the same manner, except that they have only one unit in which adjacent layers are stranded in alternate directions.

Except for the numbered tape, every nominal 50 pair or 100 pair unit is exactly the same, so that during manufacture only one type of unit is required. Thus in producing a length of 918 pair cable, for example, the stranding machine making the units is loaded with sufficient material to produce about one mile of 102 pair unit. When a suitable length

has run through to make the first unit, the numbered tape is changed and the second unit is made. The remaining units follow in a similar manner. Then when all nine units are completed, they can be stranded together into one drum length of cable.

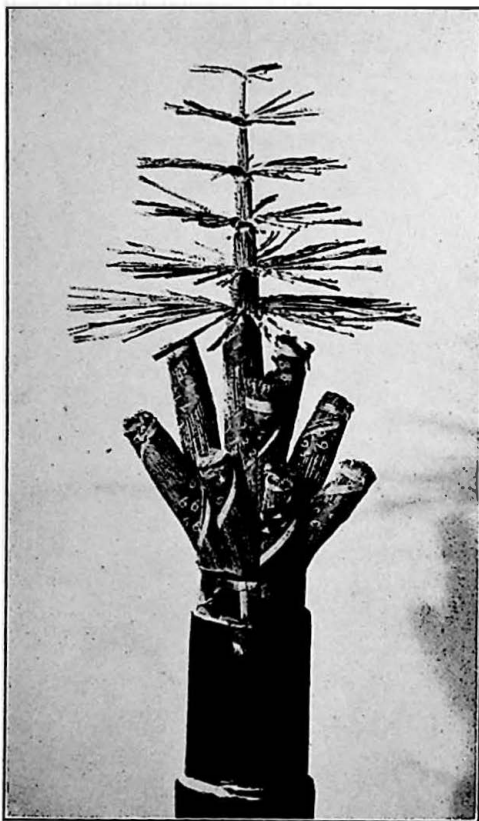

FIG. 5.—CABLE END SHOWING UNIT CONSTRUCTION.

Another useful feature of the unit identification scheme adopted is that each group of 102 pairs can immediately be identified by number. Therefore, if during installation it is necessary to number out the pairs with numbered sleeves, only the series 1 to 100 is required, instead of a variety of series dependent on the actual cable sizes. This will simplify the provision of stocks of numbered collets (when they are available).

To improve the capacitance unbalance between pairs and, therefore, the crosstalk characteristics of the cable, adjacent pairs in a layer have different lengths of lay, and pairs in one layer have different lays from those in an adjacent layer. The colour scheme is so arranged that any particular length of lay is restricted to particular pair markings, thus assisting accurate manufacture. The cotton whipping between layers, referred to above, by segregating the pairs into their proper layers at the joint, assists the identification of the pairs. In addition, it makes the intermixing of layers within the cable lengths much less likely, so improving the capacitance unbalance characteristics of the cable.

The mutual electrostatic capacitance of the 6½ lb. cable is specified as less than 085  $\mu\text{F}$  per mile, and

the capacitance unbalance between any two pairs as less than 250  $\mu\mu\text{F}$  on a 176 yard length.

The sizes of conductor available at present are 6½ lb. and 10 lb. per mile, but it is possible that other sizes will be used later, if the field trials are successful.

#### Field Trial of Post Office Experimental Unit Type Cable.

Arrangements were made for tests to be carried out on two one-mile lengths of 909<sup>3</sup> pair unit cable which were being laid as part of a field trial. The results of these tests showed that unit type pair cable is satisfactory for subscribers' distribution work; there is a great improvement in the crosstalk encountered as compared with that on quad local cable. Fig. 6 is a curve showing the distribution

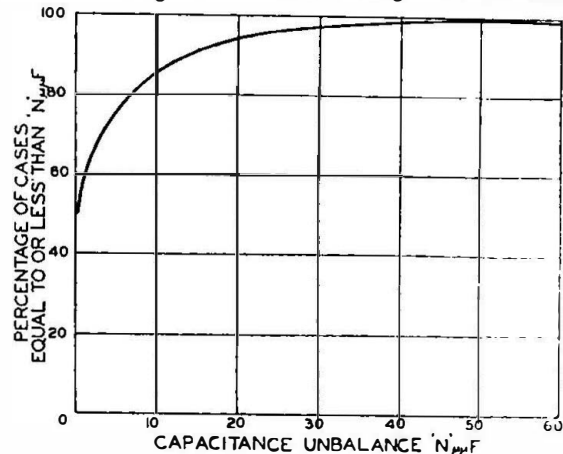

FIG. 6.—DISTRIBUTION OF CAPACITANCE UNBALANCES ON ONE UNIT OF 6½ LB. POST OFFICE TYPE UNIT CABLE. (LENGTH 1 MILE. STRAIGHT JOINTED. 5,050 CASES TESTED.)

of capacitance unbalances on a unit on which full tests were made. The values of capacitance unbalance are, in this case, numerically almost the same as the crosstalk in millionths. As can be seen from the figure, on 95 per cent. of the combinations, the capacitance unbalance is less than 20  $\mu\mu\text{F}$ , which is equivalent to a crosstalk level of 94 db. The general level of the worst values of crosstalk is about 70 or 72 db.

#### Conclusion.

It has been shown that the unit type of twin cable has many advantages over P.C.Q.L. for subscribers' distribution work, and provided the trial schemes are successful it will probably be widely used for such work in the future. War conditions have seriously restricted development work, but the cessation of hostilities has provided an excellent opportunity for introducing this unit type of twin cable on the many distribution schemes which are now urgently required. Experience with the schemes being tried will show whether the unit type cable can usefully be introduced as standard for subscribers' distribution schemes.

In conclusion, the author wishes to thank members of the Cable Test Section for co-operation during the preparation of this article, and for permission to reproduce test results.

<sup>3</sup> The experimental cable had 101 pair units as in the American type cable.

# Extension of Dialling-out Facilities in the Liverpool Director Automatic Area

F. M. McDOUGALD, A.M.I.E.E.,  
and E. L. PERKINS

U.D.C. 621.395.357

The delay in converting the Liverpool area to automatic working due to the war has necessitated an extension of the dialling-out facilities from the existing automatic exchanges to relieve the load on the Joint Trunk positions. The authors describe the measures taken.

## Introduction.

THE Liverpool director automatic system includes all the exchanges within a radius of 9½ miles from the Town Hall (see Fig. 1). There is a total of 40 exchanges within the

automatic exchanges to three manual exchanges only (viz., Anfield, Garston and Wallasey), supplemented by dialling-out from certain director exchanges to two other manual exchanges (viz., Birkenhead and Waterloo). Thus the total traffic to be completed on a dialled-out basis was small in relation to the total traffic within the area.

## Effects of the War.

The original conversion programme was first delayed by the outbreak of war and then, due to the effects of air raids, completely suspended while the urgent work of restoring the Trunk exchange and the Central, Bank and North exchanges received attention. Service for the Central, Bank and North subscribers was partially restored on an automatic basis using equipment originally installed for an adjacent exchange conversion with the temporary name of Advance. In the planning of these restoration measures, however, it was found necessary to extend the scope of dialling-out to relieve the "0" level of the large volume of traffic to the Royal and Birkenhead exchanges.

Full restoration of service to the "City" area was effected by completing the installation of the Central and North automatic exchanges and transferring the subscribers thereto. The Advance exchange was then closed. Seven other exchanges for which equipment had been manufactured and buildings were available were also opened, so that by April, 1943, there were nine director automatic exchanges working in the area.

The only further conversions which could be foreseen prior to 1950 were:—

Royal	} About 1946.
Gateacre	
Aintree	} About 1947
Irby	

Thus there would be only 13 director automatic exchanges working for a period of four to five years. Under these conditions a large volume of local (1d. to 4d.) calls would have been circulating via the "0" level for a much longer period than was

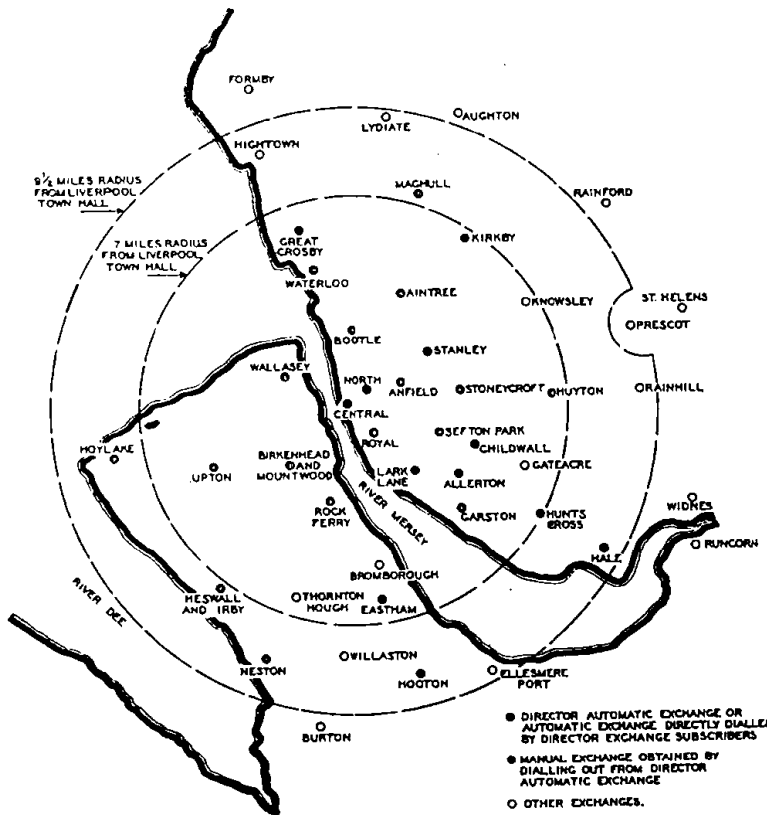

FIG. 1.—LIVERPOOL TELEPHONE AREA.

automatic area, 31 planned for conversion to director automatic working and the remainder to unit automatic equipment of the No. 14 type.

The original conversion programme was designed to provide for complete automatism within the period 1940-1943 with conversions arranged to coincide with directory issues in batches, varying in size from six exchanges in the early stages to two or three in the later stages. In these circumstances the facility of dialling-out from the director automatic exchanges to the remaining manual exchanges was adopted only to a very limited extent. The original scheme provided for dialling-out from all director

originally envisaged, involving double handling and the preparation of tickets with the subsequent sorting, pricing and charging operations. Apart from this, the large number of local calls (approximately 20,000 a day at the present time) had an adverse effect on the service given by the Joint Trunk exchange. It was therefore decided to examine the practicability of increasing dialling-out to the maximum possible extent.

Of the 20,000 calls daily, however, approximately 2,600 originated from coin-box lines, could not be diverted from the Joint Trunk positions, as these lines are barred access to dialling-out routes, and a further 2,500 originated from non-director exchanges and U.A.X's parented on the Joint Trunk exchange, had also to remain, as these exchanges cannot yet dial into the director system. This reduced the practicable scope for diversion to approximately 15,000 calls daily.

An analysis of the busy hour traffic on the Joint Trunk position is given in Table I, from which it

TABLE I.  
ANALYSIS OF BUSY HOUR TRAFFIC  
VIA THE JOINT TRUNK POSITIONS

FROM	Traffic before Extension			Traffic after Extension
	To Manual Exchanges in Director Area (excluding C.B.)	Other Calls	Total	
<i>Director Exchanges</i>				
ALLerton .. ..	140	43	183	93
CENtral .. ..	1110	1090	2200	1200
CHIldwall .. ..	264	81	345	182
EAStham .. ..	32	21	53	40
GREat Crosby .. ..	189	115	304	190
HUNts Cross .. ..	59	57	116	90
LARk Lane .. ..	181	120	301	215
NORth .. ..	233	229	462	250
STANley .. ..	88	78	166	105
<b>TOTAL (Director Exchanges) ..</b>	<b>2296</b>	<b>1834</b>	<b>4130</b>	<b>2365</b>
<i>Non-Directors and U.A.X.'s</i>				
Manual Exchange Trunk record circuits .. ..	—	—	476	476
	—	—	380	380
<b>GRAND TOTAL</b>	<b>—</b>	<b>—</b>	<b>4986</b>	<b>3221</b>

Proportion of non-coin box manual traffic from director exchanges to total manual board traffic 46%  
Reduction in traffic achieved .. .. . 35%

will be seen that, prior to the extension of dialling-out, 46 per cent. of the total traffic was from ordinary lines on director exchanges to manual exchanges in the director area and that after the extension the total manual board traffic was reduced by 35 per cent.

*Types of Manual Exchanges Involved.*

There are 25 manual exchanges in the director area at present with the following types of equipment :—

- 19 C.B. exchanges (including 2 hypothetical exchanges).
- 3 Magneto exchanges.
- 3 C.B.S. exchanges.

*Scope of Extended Scheme.*

In view of the extreme equipment and accommodation limitations at the magneto and C.B.S. exchanges and the relatively small amount of traffic concerned at most of them, it was decided to exclude these from the development of the scheme.

Of the nineteen C.B. exchanges, three (Anfield, Garston and Wallasey) were already available on a dialled-out basis to all director exchange subscribers and three (Birkenhead, Royal and Waterloo) were available on a dialled-out basis, but only from selected director exchanges. Thus the scheme fell naturally into two parts :—

- (a) To extend dialling-out from all director exchanges to Birkenhead, Royal and Waterloo.
- (b) To introduce dialling-out to the remaining 13 C.B. exchanges.

The extension of dialling-out referred to in (a) was found to be possible in two exchanges (Birkenhead and Waterloo) by straightforward extension of the existing dialling-out equipment, without unduly affecting the exhaustion dates of these two exchanges. Birkenhead is the parent for one of the hypothetical exchanges (Mountwood) and it was found possible to provide for the latter exchange also. These extensions thus catered for three additional exchanges to be made generally available on a dialled-out basis and this alone was estimated to relieve the Joint Trunk positions of approximately 1,000 calls daily. The inclusion of Royal, which would have relieved the Joint Trunk positions of a further 3,500 calls a day, would have involved a major extension at Royal which in view of its impending conversion was considered to be unwarranted.

Consideration of the remaining 12 C.B. exchanges was influenced largely by the fact that, owing to repeated deferment of conversion, apparatus rooms and switchrooms were severely congested. In addition, the exchanges were already in need of extension to meet normal development to the probable conversion date. It would obviously be undesirable to introduce dialling-out, if by so doing the exhaustion date of the manual exchange concerned was advanced to a date prior to that by which conversion could be effected and it was therefore necessary to make a full and detailed examination of each exchange.

On this basis dialling-out to seven of the remaining exchanges, including the other hypothetical exchange (Irby, on Heswall) was found to be practicable. To minimise the effect on the accommodation while ensuring the maximum flexibility, dialled-out terminations were provided on the existing jack ended "B" positions, universal cord circuits being used and metering being provided by a meter key and lamp associated with each junction. It was estimated that this extension would relieve the Joint Trunk positions of a further 1,100 calls daily.

The remaining five C.B. exchanges presented a major problem. These exchanges have considerable



community of interest with the existing director exchanges, to the extent of approximately 8,000/9,000 calls daily. The existing method of working from the Joint Trunk exchange to these manual exchanges was, however, order-wire, which meant that conversion to standard dialled-out working would involve a considerable increase in the positions required at the manual exchanges for which accommodation was not available. On the other hand, the inclusion of these exchanges was essential if material relief was to be afforded to the Joint Trunk positions. It was, therefore, decided to proceed with the development of a centralised manual board. Access to this switchboard would be obtained by dialling the first three letters of the objective exchange name as for direct dialling-out; the operator at the centralised manual board would answer with the name of the exchange required and would complete the call to the manual exchange on an order-wire basis, as at present.

*Development of Centralised Dialled-out Positions.*

An extension of the Joint Trunk positions was in progress at this time, restoring positions which had been previously withdrawn for emergency purposes, and the additional positions were being installed as the commencement of a new suite. The estimated dialled-out traffic to the five exchanges concerned proved to be within the capacity of this new suite at all stages of the proposed conversion programme and the resultant reduction in traffic on the Joint Trunk positions appeared to leave adequate margin for normal development. The conditions were, therefore, ideal, as a centralised sleeve control manual board of the right size could be made available almost immediately and staffing and circuit rearrangements could therefore be kept at a minimum. The main modifications which were found to be necessary are described in the following paragraphs:—

*Segregation of Incoming and Outgoing Circuits.—*

The provision of segregated incoming terminations presented no difficulty, as each suite in the Joint Trunk exchange is separately terminated on the I.D.F., a feature which enables a circuit to be connected to as many suites as desired by simple strapping.

Segregated outgoing terminations needed special wiring, however, as the arrangement of the outgoing multiples on the new suite provided for commoning with an existing suite on a subsidiary I.D.F. Fortunately, the commoning had not been completed and this work was stopped while a separate set of tag blocks was provided for the Trunk multiple of the new suite on the subsidiary I.D.F. To provide for ultimate restoration of the suite these additional tag blocks were wired with lengths of cable jointed to the multiple cables in such a manner that re-termination in accordance with the original specification could be effected when required. The Trunk multiple on the new suite

was then used to provide the segregated outgoing terminations necessary due to the inadequate capacity of the normal junction multiple. Incidentally, the selection of the Trunk multiple for the outgoing terminations was an advantage as operating stretch was kept at a minimum.

In addition to these segregated circuits to the exchanges concerned the circuits provided for the other suites were also available over the new positions due to the commoning of the outgoing junction multiple which had already been completed. These "common" circuits were used as an "overflow" channel to avoid the risk of calls being delayed by junctions being engaged. The normal method of reporting the "junction engaged" condition was in any case undesirable for dialled-out traffic, as the caller would be under the impression that he had already reached the manual exchange required.

*Automatic Metering.—*Provision for automatic metering of calls when the called subscriber answers was essential to enable the maximum savings in ticket preparation, accounting and clerical work to be achieved, but with the centralised dialled-out position operators completing calls by order-wire, the following problems had to be met:—

- (a) To prevent metering when the operator at the centralised manual board answered or supervised.
- (b) To ensure metering via the order-wire position and the centralised dialled-out position, when the called subscriber answered.
- (c) To prevent metering when the order-wire operator connected "engaged tone."

The normal "0" level circuit from automatic exchanges to the Joint Trunk positions was unsuitable, as it gives manual hold and non-metering conditions. It was therefore decided to use the dialling-in "0" level circuit (TL. 2157) and to prevent metering when the operator on the centralised board answers, the differentially wound relay DR (see Fig. 2) which normally operates when the speaking

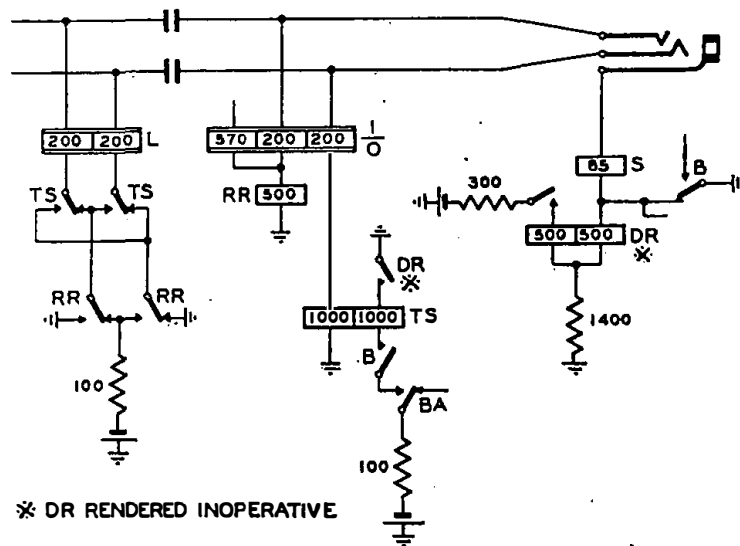

FIG. 2.—MODIFIED DIALLING-IN "0" LEVEL CIRCUIT.

key is thrown, was rendered inoperative by screwing up the residual screw. As this relay has only one function (i.e., to operate relay TS and reverse the current in the incoming line for supervision) no difficulty arises by putting it out of action.

The risk of metering when the order-wire operator connects to "engaged" tone arises from the fact that the inter-flash period of this signal is 750 mS and the interval between the S and Z pulses of the delayed metering circuit is 550 mS. Hence there is a strong possibility of premature metering if this latter interval should happen to be bridged completely by an inter-flash period. To overcome this the cam-profile of the "busy hold" springs of a Motor Generator No. 5 which are not required at the objective exchanges concerned was modified to provide a 400 mS make and a correspondingly lengthened break. These springs were used to close

Extended trials over normal junctions were then carried out with satisfactory results.

The provision of special equipment to prevent metering when the order-wire operator connected to the guard signal tone or to the monitor was considered unnecessary. Segregated groups of transfer circuits to the monitor's desk at the objective exchange were provided and the monitors arrange for the preparation of credit tickets as required.

*Additional Cord Circuits.*—The Joint Trunk positions were designed for a maximum of 11 cord circuits, but the use of the new suite for dialled-out traffic necessitated the provision of 15 cord circuits per position. There was no difficulty in providing the additional cords on the key shelf, as drillings were available, but only 11 battery tags and fuse posts per position were available. This difficulty was over-

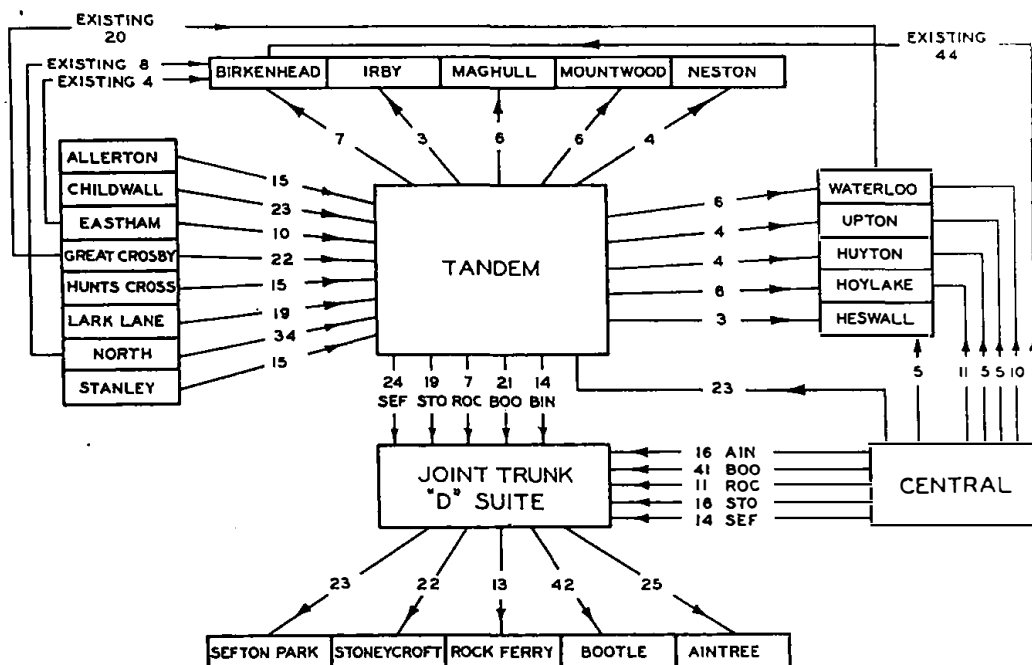

FIG. 3.—DIAGRAM SHOWING ROUTING OF TRAFFIC.

the loop on the busy-back jacks during a 400 mS portion of the normal 750 mS flash period of the engaged tone and lamp flash springs. The duration of the tone was not altered.

Trials were made with a large number of calls over experimental junctions, the machine being run at maximum and minimum voltages, and in no case was false metering recorded. The machine was tested for speed variations (both mains and battery) and it was found that, within permissible voltage limits, the effect on the modified inter-flash period was negligible provided the load remained constant. New machines were provided at each of the exchanges as the existing old type ringing machines were giving tones which were non-standard both in frequency and periodicity of interruption, but to avoid radical change in the existing ringing plant, the new machines were used solely to supply tone and flash.

come by commoning the battery feed for the additional cord circuits in pairs with existing ones.

*Routing of Traffic.*

Normal routing of traffic (i.e., direct or via Tandem) was adopted for all the exchanges to be obtained directly by dialling-out. The volume of traffic was such that direct routes were rarely justified and the traffic in the main was circulated via Tandem.

For exchanges obtained via the centralised dialled-out positions, the traffic from the majority of the automatic exchanges justified separate routes, but in view of the general shortage of relay sets at this time, it was necessary to effect rigid economy, and this was achieved by routing the traffic from all director exchanges, other than Central, via the Tandem exchange. The Central exchange was excluded, as it is in the same building as the Tandem exchange and the Joint Trunk exchange.

The exceptional use of Tandem routings for such large volumes of traffic necessitated some re-arrangement in Tandem, but as the latter had been equipped for full automatization, considerable margins were available on the existing switches and wiring. The modifications were, therefore, confined in the main to an increase in the outgoing and incoming circuits and terminations.

Fig. 3 shows in diagrammatic form the circuit arrangements adopted.

*Effect on the Automatic Exchanges.*

Apart from a substantial reduction in the "0" level circuits, which necessitated complete regrading of the remaining circuits, it was necessary to introduce new translations for the dialling-out scheme to permit of coin box lines being barred access to the dialled-out exchanges. In two or three exchanges additional first code switches had also to be provided. In addition, in view of the fact that the majority of the manual exchanges could now be reached by dialling the first three letters of the exchange name, it was decided to tee the translations of the remaining manual exchanges to the "0" level.

*Estimated Costs and Savings.*

It was estimated that the capital cost of carrying out the work involved in providing for the extension of dialling-out was £5,000 and against this the operating and clerical savings involved were estimated at £4,800 per annum.

*Publicity.*

The success of the scheme depended upon full use being made of the extended facilities which could only be achieved by adequate publicity. The date of introduction was arranged to coincide with the commencement of distribution of the July, 1945, directory, in which the first three letters of the exchanges to be dialled-out were shown in thin capitals (as adopted for the London and Glasgow schemes). The distribution of the directory occupies a considerable period under present conditions, however, and post-cards (see Fig. 4) containing a full list of the dialling facilities in a form suitable for insertion in the drawer attachment of the telephone were therefore sent to each subscriber affected. This was supplemented by articles in the local press and the operators on the Joint Trunk positions were instructed to advise all callers dialling "0" of the availability of the code dialling scheme where appropriate.

*Conclusion.*

Records taken during the first week of the scheme indicated that the estimated saving of 10,000/11,000 tickets per day was being fully realised, and that the service generally showed a marked improve-

**LIVERPOOL TELEPHONE AREA**

**IMPORTANT.**

An important development of the telephone system in Liverpool which will enable subscribers to obtain direct access to a considerably increased number of exchanges will be brought into operation at 8 a.m. on Monday next, 9th July, 1946. By your cordial co-operation and observance of the instructions given below you will speed up your own service and materially contribute towards the efficient operation of the telephone system in Liverpool.

**PLEASE KEEP THIS CARD NEAR YOUR TELEPHONE.**

If you have a drawer in the base of your telephone, cut along the line and place the lower portion of this card in the drawer.

CUT HERE

---

**IMPORTANT.**

To call a subscriber on one of the following exchanges with the first three letters in **HEAVY** capitals—

dial the first three letters of the exchange name followed by the number required.

To call a subscriber on one of the following exchanges with the first three letters in **LIGHT** capitals—

dial the first three letters of the exchange name, and when an operator answers, give the number required.

The exchanges are—

AINtree	GARston	IRBy	SEFton Park
ALLerton	GREAt Crosby	KIRkby	STANley
ANField	HALe	LARK Lane	STONeycroft
BIRkenhead	HESwall	MAGhull	UPTon
BOOtle	HOOTon	MOUntwood	WALlasey
CENTral	HOYlake	NFSton	WATERloo
CHIlldwall	HUNts Cross	NORth	
EAStham	HUYton	ROCK Ferry	

For all other Local and Trunk Calls dial "0"

For FIRE, POLICE, AMBULANCE (EMERGENCY CALLS ONLY) dial 999

FIG. 4.—POSTCARD WITH DIALLING INFORMATION FOR SUBSCRIBERS.

ment. The reaction of the public was very favourable and the staff savings realised prevented a seasonal shortage which coincided with an increase in traffic and in the rate of staff attrition following the end of the war, from becoming acute.

# The Restoration of the Anglo-French Telephone Service, 1944-1945

J. C. BILLEN

U.D.C. 621.315.28 621.315.212 621.395.44

An account of the provision of two 60-circuit submarine cable systems between Dover and Calais, and the extension of the circuits to Paris. The work included the repair and restoration of the Paris-Calais 12-channel carrier cable, and the provision of British carrier and coaxial equipment at the main repeater stations in Calais, Amiens and Paris, and mobile vans for intermediate stations.

## Introduction.

THE part played by the British Post Office in providing cable communications for the invasion of Europe in 1944 has already been described in the Victory number of this JOURNAL<sup>1</sup>. The purpose of this article is to describe how two of the coaxial submarine cables across the Straits of Dover, initially operated with 12 circuits on each cable, were subsequently equipped for 60 circuits each and extended on a 12-channel carrier cable from Calais to Amiens and Paris.

The Germans evacuated the Calais area with great speed, so that the new submarine cables between St. Margaret's Bay and Sangatte near Calais were provided at an earlier date than had originally been planned, and this fact added considerably to the difficulty in getting the communications towards Paris provided as quickly as was desired. The equipment for providing two 60-circuit systems had been installed at Dover prior to the invasion, and that for Calais was stored at strategic points in this country. In addition, two pre-fabricated buildings and a number of mobile carrier repeater stations were available for use on the French side if required.

In the September following the liberation of Paris a meeting was held between the French P.T.T., Brigadier Harris of S.H.A.E.F. and the Post Office, at which it was decided to proceed with the provision of the two 60-circuit systems. The systems were to be extended, using a 12-channel carrier cable between Calais and Paris which had been commenced before the war and completed during the German occupation, but which had been badly damaged in the subsequent fighting. It was arranged that the responsibility for the overall scheme should be undertaken by the British Post Office for S.H.A.E.F., and that a contract should be let to Standard Telephones & Cables, Ltd., in England, who were to be assisted by the French contractors, Lignes Telegraphiques et Telephoniques, to carry out all the reconditioning required on the 12-channel cable.

## Dover-Calais 60-Circuit Submarine System.

The principles governing the operation of telephone systems on coaxial submarine cables have been described in this JOURNAL<sup>2</sup> and the systems planned to give 60 circuits on each of two polythene dielectric submarine coaxial cables across the Straits of Dover are examples of the application of these principles.

Each system, shown schematically in Fig. 1, was designed to operate on a single cable over a length not exceeding 30 nautical miles. Standard No. 7

type coaxial group translating equipment is used at each terminal to assemble five basic 12-channel groups into the basic super-group range of 312-552 kc/s. The 60 channels are transmitted in this frequency range from Calais to Dover and in the reverse direction the basic super-group is modulated with a carrier frequency of 576 kc/s and the lower side band 24-264 kc/s is transmitted to the cable.

Special equipment for each 60-circuit system consists of a 10 ft. 6 in. bay at each end of the system accommodating transmit and receive amplifiers, equalisers, and directional filters for separating the two directions of transmission and also the frequency changing equipment for the B-A (24-264 kc/s) direction of transmission. This bay was designed and built by the Post Office Research Station.

The group carrier frequency of 576 kc/s is derived from the normal No. 7 type frequency generating equipment by modulating 468 kc/s, the group carrier supply for group 2, with 108 kc/s, which is channel 1 carrier supply, and selecting the resultant upper side band.

The repeater equipment for the intermediate repeater at St. Margaret's Bay comprises a single 10 ft. 6 in. bay for each system equipped with amplifiers and equalisers for each direction of transmission and the necessary directional filters for separating the two directions of transmission.

A 10-watt transmitting amplifier is used at Calais for the B-A direction of transmission which permits of a channel test level of about +20 db. into the cable at Calais. The received levels at the intermediate repeater at St. Margaret's Bay are approximately -70 db. at 552 kc/s and -50 db. at 312 kc/s, so that some 20 db. of receive equalisation is necessary. In the A-B direction of transmission with the frequency spectrum 24-264 kc/s the signals are transmitted to the cable at a relative test level of approximately +5 db. At Calais the received signals extend from approximately -22 db. at 24 kc/s to -65 db. at 264 kc/s and just over 40 db. of equalisation is required.

The submarine systems are operated over 3.5 miles of high frequency type balanced pair cable between Dover and St. Margaret's Bay repeater station. From St. Margaret's Bay repeater station the systems are extended over half a mile of balanced pair cable to a cable hut on the shore and thence over 20 nauts of coaxial type polythene dielectric submarine cable to Sangatte, a point on the coast of France about five miles west of Calais. From Sangatte to Calais the systems are extended over a further section of balanced pair cable about 7.5 miles in length.

<sup>1</sup> P.O.E.E.J. Vol. 38, p. 136.

<sup>2</sup> P.O.E.E.J. Vol. 35, pp. 79 and 121.

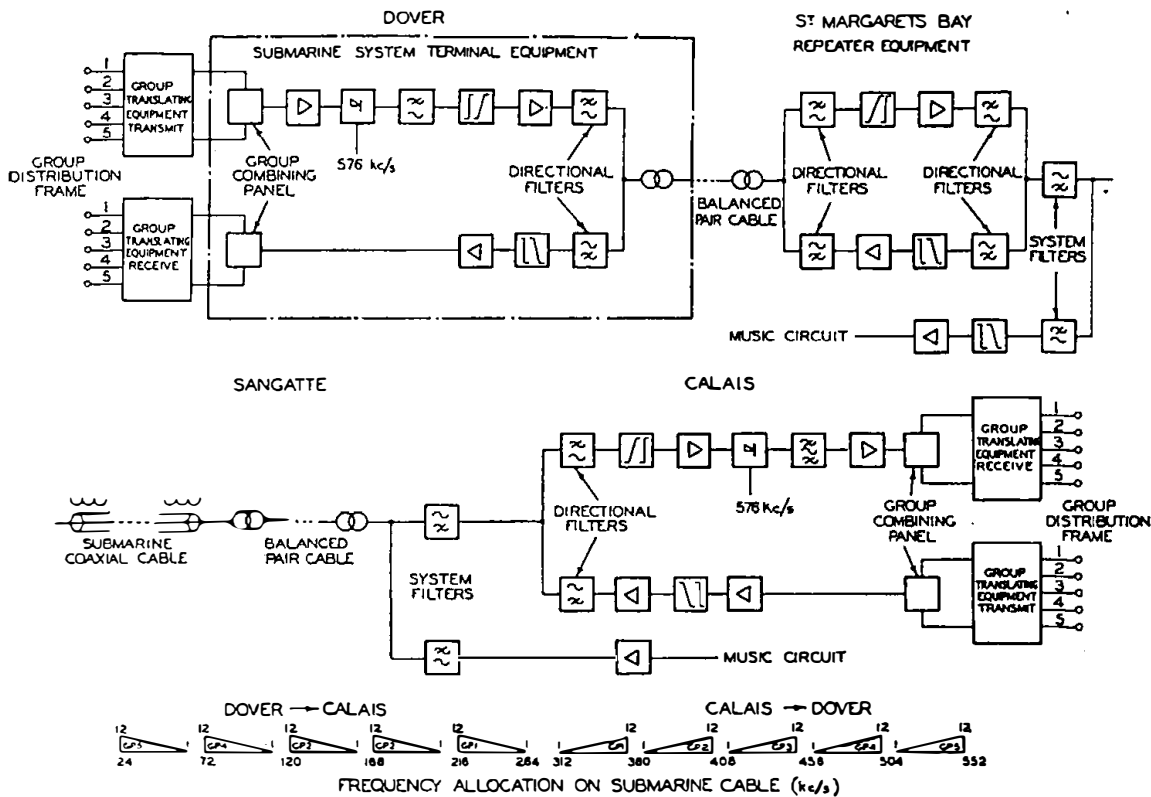

FIG. 1.—BLOCK SCHEMATIC DIAGRAM OF DOVER-CALAIS SUBMARINE SYSTEM.

*Survey.*

Early in November, 1944, a joint survey of the route was made by the British Post Office, the French P.T.T., the contractors, and Army representatives. The equipment to be installed at the various stations on the route was determined and agreement reached with the P.T.T. as to the layouts to be adopted. The general details of the Army administration for the working parties, such as accommodation, feeding, transport, etc., were also worked out during the survey.

*Balanced Pair Cables.*

Two H.F. balanced pair cables were laid between Sangatte, the termination of the submarine cables and Calais repeater station. The cable route runs inland from Sangatte to the village of Coquelles on the main Boulogne-Calais road, which is then followed into Calais. This gives a route length of approximately 11.5 kilometres, which is longer than the more direct coastal road from Sangatte to Calais. This, however, could not be used due to extensive bombing and the large number of mines. Even on the route which has been followed considerable clearance of mines from the road verges was necessary before trenching operations could be commenced.

In Calais town itself it was found possible to use the existing ducts over some portions of the route, but at others where damage had taken place it was necessary to lay new ducts. For this purpose 3 in. steel piping was used, which was supplied by the

military authorities and is of the type which was used for extending the "Pluto" petrol pipe lines inland on the Continent. To reduce the risk of damage to the cables when reconstruction and repair work is being carried out, of which there will necessarily be much in Calais, all the balanced pair cable used was armoured. A further feature of interest is that it was necessary to erect the short length of cable, shown in Fig. 2, as an aerial cable at a point where a Bailey bridge has been provided to replace a demolished road bridge over the railway. This method had to be adopted to secure a routing for the cables which will minimise a risk of disturbance when a permanent bridge is built to replace the temporary Bailey bridge. So far as is known this is the first occasion on which armoured type balanced pair cable has been used and on which this type of cable has been erected as an aerial cable; the results obtained have so far proved very satisfactory.

The excavation of the trench for the cable, the laying of the steel pipes and the building and alteration of the jointing chambers was carried out by the French contractors Lignes Telegraphiques and Telephoniques, who also assisted in drawing in the cable and jointing. Standard Telephones & Cables, Ltd. were responsible for laying the cable and provided staff from England for jointing and terminating the cable.

*Calais-Paris Cable.*

The Calais-Paris cable is a composite cable consisting of eight 40-lb. carrier quads surrounded by a

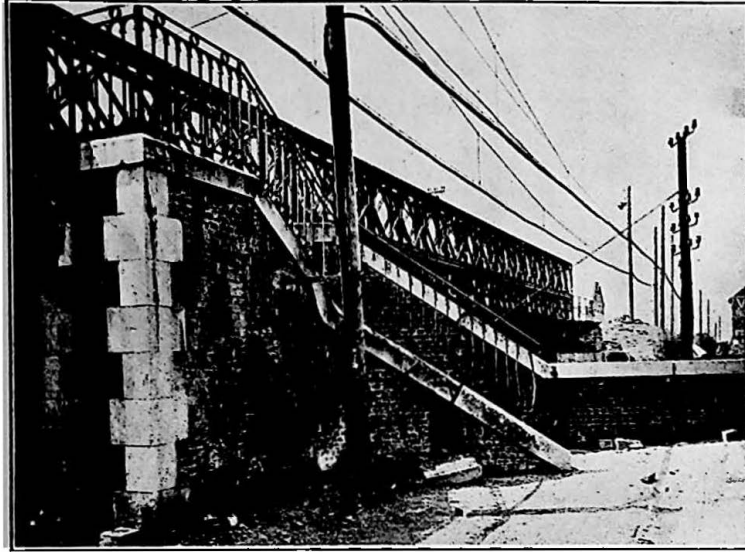

FIG. 2.—AERIAL SECTION OF BALANCED PAIR CABLE BY BAILEY BRIDGE OVER RAILWAY AT CALAIS.

screen of copper and steel helical tapes, outside which are 16 carrier pairs together with multiple twin audio quads, the number of which varies on different sections of the route. The cable was commenced just before the war and completed during the German occupation; the carrier pairs had never been used for carrier working, although on certain sections of the route the Germans had loaded them to provide additional audio circuits, furthermore, the cable had been damaged at a number of points on the route and frequently temporary repairs only had been made.

An interesting feature of the work was that due to the pairs for both directions of transmission being in the same cable, difficulty was experienced in obtaining the required figures for near-end crosstalk. At certain joints the copper and steel screen separating the inner carrier quads from the outer carrier pairs had not been correctly connected through after repairs. These joints were not always easy to find, since the work had been carried out during the German occupation, often under the shadow of secrecy, and no records of many of the repairs were held. Even after the screens had been correctly repaired, crosstalk as low as 100 db. (specification limit 120 db.) on certain combinations was found. This crosstalk had to be reduced by poling in selected joints at points within two or three kilometres from the repeater station at which the high crosstalk was measured. This was not a rapid process since the audio pairs had to be kept working and the work had to be carried out in the adverse winter weather of January and February, 1945.

The reduction of distant-end crosstalk by the use of balancing condensers fitted at the receiving end of each pair presented no unusual difficulties and followed closely the normal practice in this country.

#### *Equipment Installation at Calais.*

The equipment at Calais was installed in the

original repeater station at Rue Mollien, Calais, which fortunately had suffered no major structural damage during the bombing or fighting in the town although, as will be seen from Fig. 3, even after repairs it still shows the scars of war. The repeater equipment had been transferred from this station by the Germans to a blockhouse outside the town, leaving only cable terminations and a distribution frame in the building. To strengthen the building against aerial attack the area immediately above the apparatus room had been filled with a thick layer of concrete, and to withstand the additional weight it had been necessary to shore up the apparatus room and the power room below by numerous wooden pillars. This timbering was disposed very awkwardly in the room and interfered with the layout of the apparatus so that it was necessary to replace it by R.S.J. steelwork placed more advantageously before installation of the equipment could commence. This work was carried out by a French building

contractor for the P.T.T.

The installation of the power and transmission equipment was carried out by Standard Telephones and Cables, Ltd., and in general followed conventional lines. Fig. 4 is a general view of the carrier equipment installation at Calais. The work covered a wide range from the installation of diesel driven generators, power switchboards and secondary cells to the installation of the audio and 12-channel terminal equipment and the special high frequency equipment required for the submarine cables, and tribute is due to the versatility of the contractor's

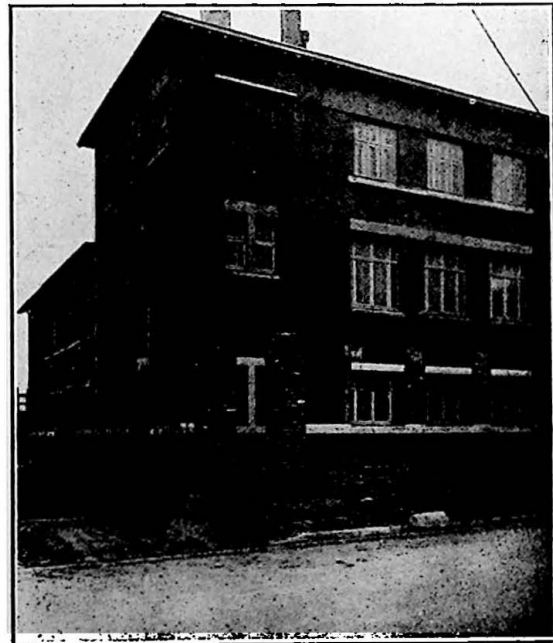

FIG. 3.—CALAIS P.T.T. REPEATER STATION.

staff employed on this work. Testing and adjustment of the equipment was carried out by the contractor's installation and laboratory testing staff with co-operation from officers of the Post Office.

During the early part of the installation, due to the lack of a public electricity supply, it was necessary to provide an emergency supply for lighting and

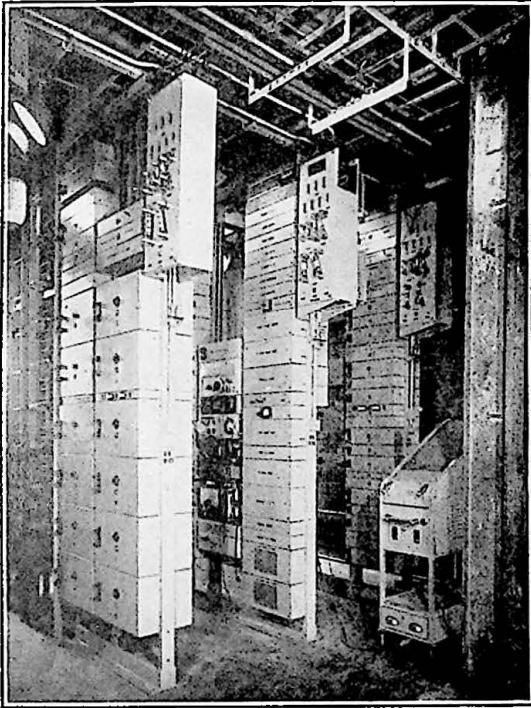

FIG. 4.—12-CHANNEL CARRIER EQUIPMENT INSTALLED IN CALAIS REPEATER STATION.

heating, and this was provided from three 18 kW petrol driven emergency type trailer generators brought from England.

The power plant serving the transmission equipment at Calais comprised four diesel driven generators arranged to float traction type secondary cell batteries, the output of each set being 150 amps at 24 volts and 7 amps at 130 volts. The sets were arranged so that they could be paralleled to meet the maximum load of the equipment. Since completion of the station the public mains supply has been restored and the French P.T.T. have installed their own standard power equipment. The P.T.T. anode supply is 220 V and it was necessary to fit "Stone" type regulators to reduce this to 130 V for the British equipment. The noise content of the P.T.T. power supply exceeds the normal limits in British repeater stations and arrangements were made to fit smoothing filters in the power supplies to the British equipment.

The diesel generators have been recovered from Calais repeater station, but it is worthy of record that the whole of the repeater station was operated from two of these generators for a period of nearly one year.

#### *Equipment Installation at Amiens.*

Four No. 7 type 12-channel terminal equipments, shown in Fig. 5, were installed in a space allocated by the P.T.T. in their main repeater station at Amiens. Normal P.T.T. practice is to conceal the inter-bay cabling either in covered cable racking or in floor chases, and as far as possible the same principle was

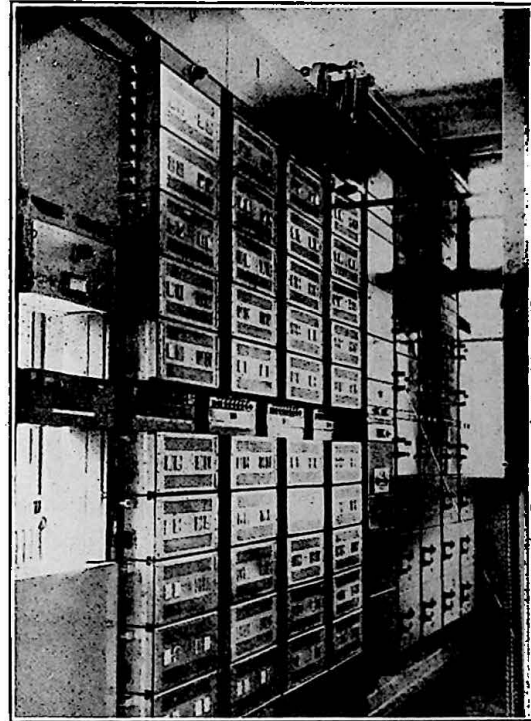

FIG. 5.—BRITISH CARRIER EQUIPMENT INSTALLED ALONGSIDE FRENCH EQUIPMENT IN AMIENS REPEATER STATION.

followed for the British equipment installed at Amiens. Power for the equipment was taken from the P.T.T. 24 V and 220 V supplies, similar filters and voltage regulators being installed as at Calais.

#### *Equipment Installation at Paris.*

Ten No. 7 type 12-channel terminal equipments were installed in the P.T.T. repeater station at Rue St. Amand, Paris; this building is a large modern repeater station completed in the early part of the war. The basement accommodation had been used by the Germans as a protected repeater station during the occupation, and no equipment had been installed above the ground floor. The equipment in the basement had been completely demolished by the Germans before they left Paris, but fortunately the great strength of the building had prevented any damage to the upper floors. A clear space on the first floor was allocated by the P.T.T. and the installation shown in Fig. 6 followed normal practice.

Here again power supplies were obtained from the P.T.T. power equipment and similar arrangements as at Calais and Amiens have been provided for noise filters and voltage regulators.

### *Unattended Repeater Stations.*

At five of the unattended repeater stations on the route the 12-channel cable pairs had been terminated on cable terminations in the intermediate repeater station buildings, but no equipment had been provided.

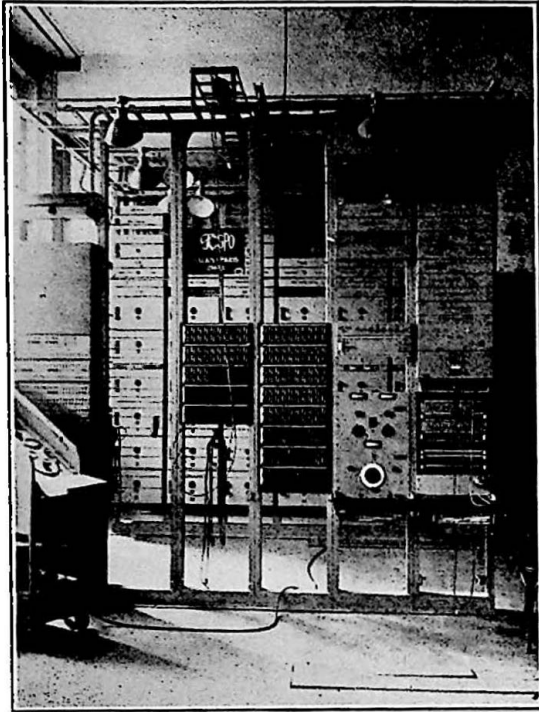

FIG. 6.—12-CHANNEL TERMINAL EQUIPMENT INSTALLED IN PARIS (RUE ST. ANAND) REPEATER STATION.

For these stations Post Office mobile carrier intermediate repeater station trailers were used and were placed in suitable positions in the yards of the stations. The carrier pairs were extended from the cable terminating bays in the main building to the mobile repeater stations using carrier type lead covered 24-pair cables. The mobile repeater station at Tilques is shown in Fig. 7, where the carrier cables were suspended overhead across the yard of the station.

The mobile equipments are mains operated and power is normally obtained from the public mains supply. To cover mains failures diesel operated emergency 4.5 kVA alternators, supplied by the Army, have been installed, which are complete with a control switchboard and arranged to start up automatically in the event of a mains failure. The engine is arranged to shut down on mains restoration and an alarm condition is extended to the nearest main station for the duration of the mains failure.

### *Organisation of the Work.*

It will be appreciated from what has already been said that the work of providing the two 80-circuit telephone systems and their extension over the 12-channel cable to Paris represented an unusual operation for the Post Office from the administration point of view. The work had to be carried out in a

foreign country which had only recently been liberated from the enemy, so that conditions were such that French civilian resources could not be used for accommodation, feeding or transport.

The personnel employed on the work comprised a small team of supervising officers of the Post Office Engineering Department, contractor's supervising officers for both the internal and external work and contractor's workmen. From the commencement of the work the Army appointed a full-time liaison officer who was responsible for the general and detailed administration of the various working parties, their accommodation and feeding, the supply of transport required for moving stores, etc., and the supply of military labour for loading and unloading heavy stores and similar operations.

To simplify the Army administration the civilian staff employed on the work were divided into officer and sergeant status. This was quite a convenient arrangement, as supervising officers naturally fell into the officer class, whereas all workmen were given the assimilated rank of sergeant in view of the technical and skilled nature of the installation work.

The number of personnel employed on the scheme varied during its progress and reached a maximum of approximately 75 during the peak of the work. The problem of administrating this number of British civilians whose distribution over the route between Calais and Paris continually changed, represented an unusual and difficult one for the Army and the

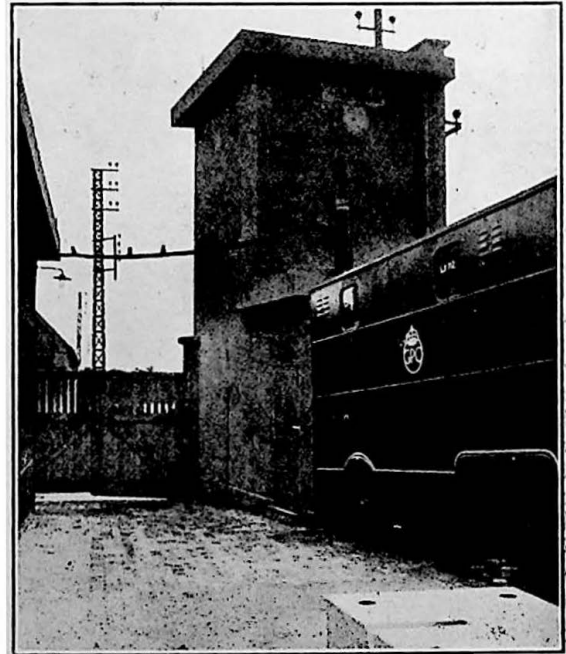

FIG. 7.—MOBILE CARRIER REPEATER STATION IN USE AT TILQUES.

highest praise is due to the Army liaison officers for the successful manner in which the task was accomplished.

A further complication was that the parties were operating over territory which was under partly British and partly American military control; further-



more the boundary of these controls altered during the progress of the work, so that at Amiens, for instance, the earlier accommodation was provided by the British Army and later by the Americans.

#### *Transport.*

Transport for the movement of personnel and stores was a constant source of difficulty which was made all the more acute by the extremely bad condition of the French roads. Standard Telephones and Cables originally took over from this country sufficient transport for day to day movement of the working parties and their equipment, but it was subsequently found that conditions were such that wear and tear was greater than anticipated and a number of Post Office 30 H.P. utility vans were taken out. Considerable help was obtained from local R.E.M.E. Units, who were responsible for repairs to the vehicles, and here again the Army was presented with an unusual problem which was not always capable of easy solution, and it was frequently necessary to have spares sent over from England before a vehicle could be put into service again. In this respect the standard 30 H.P. Army-type vehicles of the G.P.O. constituted an easier problem than the contractor's vehicles, since spares could usually be obtained through normal Army channels.

The Army supplied transport for carrying rations and also for the movement of all major items of equipment and stores on the work.

The weight of stores used on the scheme amounted in all to nearly 200 tons, all of which had to be shipped from England and collected at the port of delivery on the Continent. The main batch of equipment arrived at Boulogne in December, 1944, and consisted of approximately 120 tons of transmission equipment and installation material and also the first batch of drums of balanced pair cable. Subsequent shipments arrived at Calais and at Ostend. The five mobile carrier repeater stations were disembarked at Ostend, so that they had an appreciable overland journey to their sites at the intermediate stations between Calais and Paris.

#### *Progress of the Work.*

The first working party left Tilbury for France on 3rd December, 1944. The journey to Calais, although lengthy, proved extremely interesting, since the party travelled as a military unit and went through the same process as all such units which had been shipped to the Continent since D Day. The journey from Tilbury to Ostend was made by L.S.T. and the party made its own way from Ostend to Calais by road, arriving there on the 9th December.

The work of unpacking the equipment and material commenced forthwith and towards the end of December the emergency power trailers were delivered and temporary lighting and heating for Calais repeater station provided. During December good progress was made in laying pipes in Calais for the balanced pair cable and in laying the cable in trenches outside the town. Unfortunately it was not possible to make immediate progress with the installation of equipment at Calais repeater station due to delay in the removal of the wooden pillars and their replacement

by steel work. However, by 15th February, 1945, two of the diesel operated power generators and associated equipment were ready to supply power for the transmission equipment and after preliminary adjustments, tests on the equipment at Calais commenced on 1st March.

On 23rd March one of the 12-channel systems between Dover and Calais was ceased and the cable extended to the 60-circuit equipment at Calais via one of the balanced pair cables. The high frequency line-up of the 60-circuit system commenced, and on 28th March the first of the five 12-channel groups was handed over for traffic as a London-Calais group. The remaining four 12-channel groups were brought into use during the first week in April.

Installation work at Paris repeater station commenced early in April, 1945, and work on the 12-channel cable was completed early in May. The installation and tests at the intermediate stations between Calais and Amiens were completed and this section of the route was ready for service by early June, 1945, and two 12-channel groups between London and Amiens were lined up and handed over to traffic on the 22nd June.

The first two 12-channel groups between London and Paris were completed and ready for service towards the end of July and public circuits in these groups were opened for traffic early in August, 1945.

#### *Conclusion.*

In conclusion, it is interesting to note that the completion of the two 60-circuit systems across the Straits of Dover increased the circuit capacity between this country and the continent to approximately 250, which compares very favourably with the 200 circuits which was approximately the number available before the war. This position had been reached in little over a year from the date of invasion of Europe.

It is also of interest to note that of the 200 pre-war circuits approximately 30 per cent. were carrier circuits and that the Anglo-Dutch were the only two coaxial type submarine cables. Of the 250 circuits provided by the summer of 1945 nearly 90 per cent. were carrier and of the 14 cables concerned 11 were of the coaxial submarine type.

The present position is that of the ten 12-channel groups provided by the two 60-circuit systems, six are being operated as 12-channel groups between London and Paris, the remaining four groups terminating at Calais, from where the circuits are extended inland on an audio basis. The six London-Paris 12-channel groups provide the main bulk of the London-Paris traffic circuits, for which over 40 are now in use, other circuits being extended on an audio basis to provide direct circuits to Switzerland, Italy, etc. In addition to the carrier groups, the frequency spectrum below 24 kc/s on each of the two submarine cables has been used to provide high quality unidirectional music circuits between London and Paris.

The author wishes to acknowledge with thanks the assistance in the preparation of this article given by Mr. F. Ralph of Standard Telephone & Cables, Ltd.

# A Simplified Cable Balancing Instrument

H. C. S. HAYES, A.M.I.E.E., and  
E. D. LATIMER

U.D.C. 621.317.34

## Part 2.—Use of the Instrument in the Field

Capacitance unbalances accumulate when lengths of cable are jointed together "straight," and in Part I of this article the use of a simple balancing instrument for preventing such accumulation within a cable quad was described. In Part II details of field tests carried out with the instrument are given and the types of cable likely to be balanced satisfactorily by its use are discussed in the light of the results obtained.

### First Experimental use of Instrument in the Field.

THE first instrument made was similar to the one described in detail in Part I of this article, except that it did not include crosstalk measuring facilities or artificial cables for checking its operation. With this early model field tests were carried out to demonstrate the extent to which accumulation of unbalances could be prevented by using the instrument between the single lengths of a quarter section as originally intended and, in addition, at the three remaining joints between quarter sections.

Two typical loading sections, each approximately 2,000 yards in length, were chosen for the trials, the one consisting of 12 cable lengths and the other of 13 lengths. The results in the form of pillargraphs for the 12-length section are shown in Fig. 1. The results for the 13-length section were of the same general order but there was a rather greater improvement resulting from the use of the instrument than in the example shown. The type of cable was P.C.Q.L.

To obtain the comparisons shown in Fig. 1 the capacitance unbalance characteristics were measured on every length. Pillars 1-12 record the mean and maximum side-to-side unbalances for each of the single lengths. Pillar 13 shows what the corresponding unbalances would have been without any balancing had the quads been systematically jointed in the normal way at every joint with the wires straight, the figures being computed from a knowledge of the magnitude and sign of the unbalance on each quad and the order in which the quads would have been jointed according to the systematic jointing schedule. Pillar 14 shows the side-to-side unbalance actually obtained with the quads systematically jointed, but with wire crosses introduced to conform with the indications given by the instrument at each joint. The lengths were jointed in the following sequence:—1 to 2, (1 + 2) to 3; 4 to 5, (4 + 5) to 6; 7 to 8, (7 + 8) to 9; 10 to 11, (10 + 11) to 12, followed by (1 + 2 + 3) to (4 + 5 + 6) and (7 + 8 + 9) to (10 + 11 + 12) and finally by (1 + 2 + 3 + 4 + 5 + 6) to (7 + 8 + 9 + 10 + 11 + 12).

### Degree of Unbalance Reduction.

(a) *Side-to-Side (p-q).* When unbalances are reduced by test selection methods the residual values are normally but a fraction of the unbalances in the original lengths; as a point of interest it can be stated that they were found, when the 12-length section was later balanced by test selection, to be

35 $\mu\mu\text{F}$  maximum and 13 $\mu\mu\text{F}$  mean. This is largely due to the selection process whereby a quad with unbalances of particular type and size is specially selected to be jointed to a quad with similar unbalances of about the same magnitude, wire crosses being introduced so that the unbalances tend to cancel one

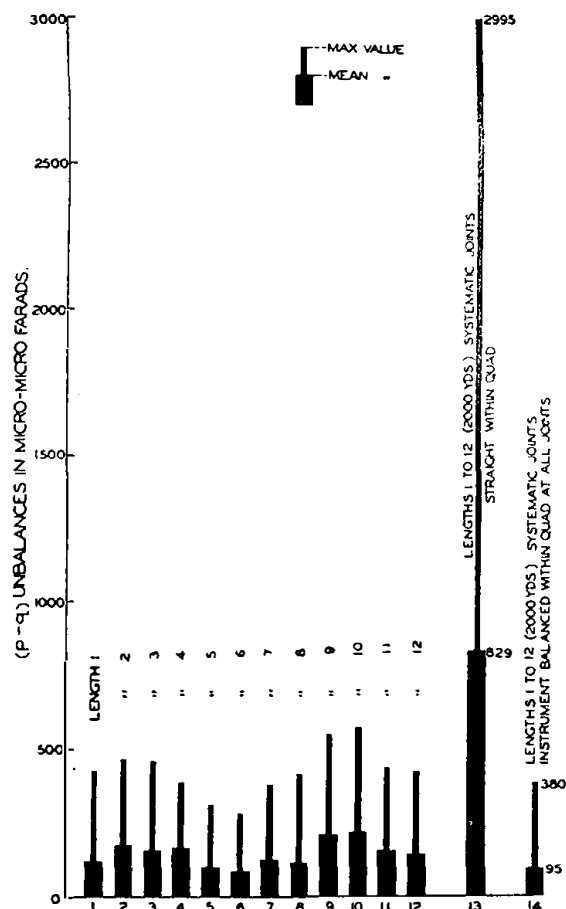

FIG. 1.—SIDE-TO-SIDE (p-q) UNBALANCES WITH AND WITHOUT USE OF INSTRUMENT. 100 PR. 20 LB. P.C.Q.L. CABLE.

another out. Reduction of the same order was not obtained with the balancing instrument because there was no selection of the pairs or quads to be jointed together. They were taken for jointing strictly in the order of the systematic jointing schedule, a pointer on the machine merely indicating to the tester whether or not he should insert a cross into one of the

pairs to prevent accumulation between the side-to-side unbalances of the two lengths. Although the reduction of the unbalances was much less than when test selection was employed, it was, nevertheless, very material as will be seen by comparison of pillars 13 and 14. Had the instrument not been used the maximum side-to-side value would have been  $2,995\mu\mu\text{F}$  instead of 380, and the mean value 829 instead of 95. A little reflection will show that if the instrument is used at every joint to reduce  $(p-q)$ , no matter how many lengths of a balancing section are finally connected together, the maximum residual unbalance on the aggregate of lengths can never exceed the largest  $(p-q)$  unbalance which occurs among the single lengths.

(b) *Phantom-to-Side* ( $p+q+\frac{1}{2}u$ ) and ( $r+s+\frac{1}{2}v$ ). Although the instrument would probably not normally be used to reduce unbalances other than side-to-side, facilities are provided in its make-up for phantom-to-side and side-to-earth unbalances to be considered. A cross introduced for the control of side-to-side unbalance may be placed in either the AB or CD pair, and if the instrument is used to indicate how the AB pair should be jointed to effect reduction of the phantom-to-AB unbalance, and also how the CD pair should be jointed to effect reduction of the phantom-to-CD unbalance, it is clearly possible to place the cross required for the side-to-side reduction so that it benefits the phantom-to-side unbalances to some extent. This was done in the experiment and a marked reduction of the phantom-to-side, in addition to the side-to-side, unbalances resulted, the figures for the 12 length section being as shown in Table I.

TABLE I  
LENGTHS 1-12 (2,000 YARDS) ALL JOINTS SYSTEMATIC.  
MAXIMUM UNBALANCE CHARACTERISTICS IN  $\mu\mu\text{F}$ .

	Side-to-Side ( $p-q$ )	Phantom-to-Side AB ( $p+q+\frac{1}{2}u$ )	Phantom-to-Side CD ( $r+s+\frac{1}{2}v$ )	Side AB-to-earth ( $u$ )	Side CD-to-earth ( $v$ )
Straight within-quad (computed)	2,995	5,565	5,535	1,190	985
Instrument balanced at all joints	380	1,450	1,620	1,035	750

The side-to-side unbalance  $(p-q)$  affects directly the amount of overhearing between the side circuits of a quad and its reduction to reasonable limits is, therefore, most important in cables carrying 2-wire circuits and/or 4-wire circuits operated on a group basis. Thus, in the experiment, reduction of the side-to-side unbalance was the prime objective; phantom-to-side unbalances were treated as a secondary consideration and no attempt was made to control the earth unbalances which, as will be seen from Table I, were sensibly unaltered when the instrument was used to control the other three unbalance characteristics. Had it been desired, some control of the side-to-earth unbalances could have been arranged but improvement in these characteristics could only

have been obtained by reducing the improvement in the phantom-to-side values.

#### *Strict Adherence to Systematic Jointing.*

The jointing of quads in strict "systematic jointing schedule" order, as was done in the experiment, simplifies their identification during maintenance operations as well as effecting the primary purpose of reducing the quad-to-quad unbalances as much as possible. When normal balancing technique is employed it is usual to have in each loading section three test selected joints at which the systematic schedule is departed from to allow treatment of the within-quad unbalances. With the balancing instrument technique, however, the systematic schedule is followed exactly at all joints and this feature is considered a desirable one.

#### *Later Use of Instrument in the Field.*

An examination of Fig. 1 shows that the maximum and mean side-to-side capacitance unbalance values are both reduced to about  $\frac{1}{8}$  of the values they would have been without the use of the instrument, and this represents an improvement of about 18 db. in the side-to-side crosstalk. The improvement was obtained by the use of the instrument at each of the 11 joints in the 2,000 yards section, and this necessitated the insulating of 12 cable ends. The insulating of ends is additional work, and to reduce it as much as possible the use of the instrument only at the three joints linking the quarter sections was considered. This reduces the improvement but it is still considerable, and from calculations made with the measured figures on the individual lengths it has been shown that for this particular case an improvement of 13 db. would have been obtained.

Eight outlet cables of P.C.Q.L. type, connecting air-fields with the main cable network, and varying in length from 1 to 7 miles, were balanced, using the instrument at the three joints linking the quarter sections only. This work carried out during the war was of the greatest urgency, and it was not possible to investigate the magnitude of the unbalances of the individual lengths, nor to measure the crosstalk on completion, as the cables were required for service with the absolute minimum of delay. The improvement obtained is not therefore known, but the cables were found to be quite free from overhearing and interference under working conditions.

#### *Crosstalk Predicted from use of the Instrument.*

The improvement obtainable with the instrument, although much smaller than that resulting from test selection technique, is adequate for certain classes of cables. Fig. 1 shows that the maximum side-to-side unbalance with instrument balancing at every joint was  $380\mu\mu\text{F}$ , which in a cable of 1,100 ohms impedance (88 mH loading at 2,000 yards) corresponds to a crosstalk contribution from this loading section of about 68 db.; thus, with P.C.Q.L. cable, when due allowance is made for accumulation between loading sections, it would be expected that the *worst case* of near-end or far-end within-quad crosstalk in a loaded cable 2 or 3 miles in length, would be at least 64 db.

Such crosstalk would be adequate for tie cables or other short cables carrying :—

- (a) 4-wire circuits worked within-quad, as these do not require a high degree of immunity from within-quad crosstalk.
- (b) 4-wire circuits worked on a group basis, as the two pairs of a quad then normally carry circuits transmitting in the same direction with negligible level differences between them.
- (c) 2-wire unamplified circuits. These would normally have level differences between them not exceeding 4.5 db.

These deductions as to crosstalk magnitudes are based on the first field trial which was somewhat limited in extent, but nevertheless the values are felt to be typical of what may be expected from P.C.Q.L. cable instrument balanced at every joint, as the pillargraphs for the single lengths shown in Fig. 1 are adjudged to be fairly representative of what may be expected in practice from this type of cable.

P.C.Q.T. cable has unbalances which are generally rather less than one quarter of those of P.C.Q.L. cable, and with the former type, the instrument could be used at the three-quarter section joints only to give crosstalk about 7 db. better than that obtainable by using the instrument at all joints on P.C.Q.T. cable. It is estimated that with this higher grade of cable balanced at 3 joints per loading section the length of cable capable of carrying the classes of circuits referred to above could be increased to 10 miles or possibly more. This assessment is based on the following considerations :—

- (1) Maximum side-to-side unbalance on 2,000 yards of P.C.Q.L. cable, instrument balanced at all joints was  $380\mu\mu F$ , which for a 1,100 ohms impedance circuit corresponds to a crosstalk contribution of 68 db.
- (2) Experiments and calculations with measured figures showed that for representative P.C.Q.L. cable an 18 db. improvement in side-to-side crosstalk was obtained when the instrument was used at every joint, and that a 13 db. improvement resulted when it was used at the three joints linking the quarter sections.
- (3) From (1) and (2) a maximum side-to-side crosstalk contribution of about 63 db. on a 1,100 ohm circuit could reasonably be expected from 2,000 yards of P.C.Q.L. cable instrument balanced at three joints only.
- (4) P.C.Q.T. cable has unbalances about one quarter those of P.C.Q.L. cable and this corresponds to 12 db. better crosstalk from the former type.
- (5) From (3) and (4) a maximum side-to-side crosstalk contribution of about 75 db. on a 1,100 ohm circuit could reasonably be expected from 2,000 yards of P.C.Q.T. cable instrument balanced at three joints.
- (6) A cable about 10 miles long contains approximately 9 loading sections, and if each of these contributes a maximum crosstalk of 75 db. it would be reasonable to expect a maximum value

overall of about 69 db. for both near-end and far-end side-to-side crosstalk when allowance is made for random accumulation and for the attenuation of the line. Such a value would be quite adequate for the classes of circuits listed above, especially when it is remembered that maximum values are being considered and that the general level of side-to-side crosstalk will be considerably better than 69 db.

*Newcastle (Central)—Newcastle (Kenton) Tie Cable.*

This 4 pr/40 screened + 980 pr/10 P.C.Q.T. cable of length 2.890 miles with most of the pairs loaded with 44 mH coils at 2,000 yards and the remainder of the pairs non-loaded was recently balanced, using the instrument at the three joints linking the quarter sections in each loading section. All the joints were made on a systematic basis and the wires within each quad jointed straight, except where wire crosses were introduced at the points where the instrument was used. The near-end crosstalk results measured with a standard Post Office crosstalk set on the finished cable are given in Table II.

TABLE II

	Near-end Crosstalk in db. (corrected for impedance).			
	Side-to-Side		Phantom-to-Side	
	Mean	Max.	Mean	Max.
Loaded Pairs ..	85	74	73	55
Non-loaded Pairs.	92	80	75	63
Screened Pairs (straight jointed throughout) ..	> 106	> 106	—	—

As is frequently experienced with 10lb. conductor cables there was a small percentage of faulty circuits, chiefly due to split pairs and high resistance joints, and about 3 per cent. of the total crosstalk readings which were high and directly attributable to these faults were excluded from the readings summarised in Table II.

Both the first instrument made and the developed model described in Part I of this article were used simultaneously by testing officers on different sections of the cable to effect early completion. The balancing scheme aimed at reducing the side-to-side unbalances and to a lesser extent the side-to-earth unbalances, but did not attempt to control the phantom-to-side unbalances.

It is estimated that had this cable been balanced in the normal way about 5,500 man-hours would have been expended on the balancing work. About 4,000 man-hours of this total were saved by using the instruments as described.

*Scope of Use of Instrument.*

Some types of cable which, it is felt, could be balanced with advantage by use of the instrument

ditions where it could be usefully employed follows:—

ie cables. These usually connect stations with the confines of towns and rarely exceed three miles in length.

Subscriber's quad cables, particularly if, in the future, the improved efficiency of telephone instruments demands a higher standard of crosstalk and it is necessary to bring existing quad cables more into line with twin cables in far as the former's side-to-side crosstalk is concerned.

port junction cables.

Trunk or junction cables of any length if worked solely on a 4-wire within-quad basis.

Cables required to be installed very quickly, in remote situations where it is difficult to make the normal balancing equipment or skilled staff available, or where the dictates of expediency justify some departure from the high standard of balance obtainable by standard cable balancing methods.

Where listening tests are made difficult or impossible by road traffic, aircraft or other noises, such conditions the visual indication makes special appeal.

Random-to-side, and side-to-earth unbalances can be balanced with the instrument described, relatively high when compared with those normally balanced by full test selection in the day, but it is considered that this will not affect the working of the cable, although experience of the behaviour of a number of cables tested with the instrument will be necessary to reach a definite conclusion on this point is reached. In the case of a castle tie cable, it should be stated, is now working circuits and it appears satisfactory results.

#### Balancing by Crosstalk Switching.

For small cables the Post Office Engineering Instructions (Lines, Underground, G1063) permit of crosstalk switching tests being made instead of the full balancing procedure, and the instrument can cater for this scheme. Briefly, one of the methods of carrying out crosstalk switching is to measure the crosstalk of all quads both ways from the centre jointing point in a loading section, to arrange the values for each side in order of magnitude, and then, taking the quads in this order, to ascertain by further crosstalk tests from the centre jointing point what cross in the pairs, introduced by trial and error switching, improves the overall result most. This involves the jointer in the clipping-on of the quads from the two cable ends twice and the testing officer in the making of three sets of crosstalk tests.

Since the sign of the crosstalk can readily be determined with the instrument a simplified procedure for dealing with side-to-side crosstalk may be employed which is based on very simple selection rather than switching. The magnitude and the sign of the side-to-side crosstalk is measured first on one side and then on the other, and the joint is scheduled by selecting for joining together quads taken in order of magnitude and arranging for their straight jointing if their crosstalk values are of different sign and for the crossing of one pair if their crosstalk values are of the same sign. In this case, the jointer is involved in clipping-on the quads from the two cable ends once only and the testing officer makes but two sets of crosstalk tests.

#### Acknowledgments.

Thanks are due to colleagues of the Engineering and Factories Departments, particularly to E. H. Truslove, B. K. Mooney, and H. G. Bassett, for their assistance and advice in bringing the idea of the simplified balancing instrument to fruition.

### TELEGRAPH AND TELEPHONE STATISTICS—SINGLE WIRE MILEAGES AS AT JUNE, 1946 THE PROPERTY OF AND MAINTAINED BY THE POST OFFICE

REGION	OVERHEAD			UNDERGROUND		
	Trunks and Telegraphs †	Junctions ‡	Subscribers* †	Trunks and Telegraphs †	Junctions ‡	Subscribers †
Atlantic .. .. .	13,873	44,745	352,114	1,820,921	426,547	1,446,095
Eastern .. .. .	6,335	39,259	266,565	958,202	177,661	800,968
Border Counties .. .. .	4,759	34,202	210,945	1,025,805	301,127	1,051,610
Western .. .. .	7,516	30,788	148,400	533,718	81,360	331,462
Eastern .. .. .	9,828	21,648	177,534	851,098	242,592	1,017,667
Island .. .. .	892	9,235	111,529	653,380	371,114	1,267,817
.. .. .	9,816	11,422	34,700	109,880	43,539	144,431
.. .. .	20,466	34,641	186,277	766,260	248,094	861,244
.. .. .	73,485	225,920	1,488,064	6,719,264	1,892,034	6,921,294
.. .. .	467	1,545	76,373	916,327	1,774,686	3,786,962
.. .. .	73,952	227,465	1,564,437	7,635,591	3,666,720	10,708,256

† Includes all spare wires.

‡ All wires (including spares) in M.U. Cables.

† All wires (including spares) in wholly Junction Cables.

‡ All wires (including spares) in Subscribers' and mixed Junction and Subscribers' Cables.

# Flexibility Units for Local Line Networks

U.D.C. 621.315.68 : 621.395.74

## Part I.—Pillars, Cabinets and Combined Units

J. J. EDWARDS, B.Sc.(Eng.), D.I.C., A.M.I.E.E., and  
J. P. HARDING, B.Sc.(Eng.), A.M.I.E.E.

The first part of this article explains the need for flexibility units in local line networks and describes the cabinets and pillars now being introduced for this purpose. The second part will give more detail of the interior of the units.

### *Need for New Methods of Flexibility.*

THE inadequacy of auxiliary joints and of the simple teeing methods hitherto employed by the Post Office for obtaining flexibility in local line plant has been recognised for some years and is discussed in official reports and I.P.O.E.E. papers.<sup>1</sup>

Briefly, such methods have been satisfactory where the departures from forecasts have been small and the variations of growth in adjoining areas not unduly large. Where, as is most usual, large variations from the forecast growth in adjoining areas are encountered, experience has shown that the cost of rearrangement of plant becomes unduly high despite a liberal proportion of spare wire in the local cables. An 80 per cent. fill for a cable has generally been found to be about the economic limit beyond which the opening of joints and the rearrangement of wires for the connection of additional circuits becomes more costly than the laying of additional cable.

The present circumstances are that in most areas many subscribers are awaiting service which it is desired to give as quickly as possible. To attempt to overtake arrears in the normal development programmes would involve heavy material and labour costs and, even if labour were immediately available, considerable time would inevitably be needed to manufacture and lay the necessary plant.

The installation of cabinets and pillars containing cross-connection strips whereby the spare wires in cables may be made immediately available without the excessive and costly rearrangements of plant hitherto involved is therefore particularly attractive, especially if the same apparatus can be employed as the standard means of providing flexibility. Under these conditions it is economical to connect up and employ almost the whole of the pairs in a cable and to realise a considerable increase in capacity over the percentage of circuits (80 per cent.) previously stated. Existing cables may therefore be given a new lease of life by which the early connection of many waiting subscribers will be possible. By a judicious choice of the point in the external cable network at which a cabinet or pillar is to be installed and, in addition, perhaps a small extension of plant, it will often be possible to secure the immediate advantages already discussed and, simultaneously, to ensure the satisfactory siting of the unit as a permanent flexibility point.

### *Requirements for Flexibility Units.*

Overground flexibility units have been used for

<sup>1</sup>I.P.O.E.E. Printed Papers Nos. 170 and 180.

some years on the Continent, notably in Germany and the Scandinavian countries, but it is the impression of the authors that the design of the apparatus used has not received the attention that it deserves.

For example, serious disadvantages of early cross-connection units were the unsatisfactory insulation of circuits and congestion in the jumper field, inevitably reflecting in the occurrence of faults due to the frequent manipulation of jumpers. Another feature which made awkward the connection of the units to the external cable network was the large number of small cable tails involved—frequently so many as 12-15 for a cabinet of medium size.

The range of cabinets and pillars and associated apparatus briefly described in this article represents an attempt to prepare designs of apparatus which will provide as efficiently as possible the required cross-connection facilities in the minimum space while preserving an orderly layout throughout the period of installation. Particular attention has been given to the maintenance of satisfactory insulation under adverse conditions, the avoidance of disconnections and contacts in service and the choice of the most convenient means for the connection of units to the local cable network.

### *Insulation of Circuits and Avoidance of Condensation.*

The maintenance of insulation under adverse conditions requires either that (a) condensation of water in the interior of the unit be avoided at all times, or (b) that the possibility of condensation be accepted and its effects on insulation minimised as far as possible by the use of a form of terminal strip employing long leakage paths. It was found that the dimensions of a terminal strip fully to meet the conditions of (b) prevented the compact layout possible in (a) which alternative was adopted to accommodate sufficient circuits in a unit suitable for street mounting. The development of a new design of terminal strip more suitable for use in external situations was, however, proceeded with separately.

The cost of a heated installation was found prohibitive in so small a unit and an examination was made of a cabinet both with and without an inner lining for thermal insulation, a ventilated cabinet and the use of a suitable desiccant in a sealed cabinet.

Condensation occurs when the temperature of the enclosed air falls below the saturation temperature for the particular value of humidity at the time of enclosure. The extent of condensation (gm. of water condensed) may be deduced from the temperature at the time and the volume and humidity of the enclosed air, greatest condensation occurring when

the cabinet is closed under conditions of high humidity (in summer weather) and the temperature subsequently falls considerably (e.g. at night).

A cabinet in which the interior is thermally insulated from external influences would, by causing the temperature of the interior to lag behind the external changes in temperature, reduce the minimum temperature attained and thus the effects of condensation. Clearly, the improvement to be obtained in this way depends on the degree of thermal insulation which it is possible or practicable to provide and also on the rate of change of external temperature. For a body of thermal capacity  $C$  and for a temperature change  $\theta_1 - \theta_2$  (reckoned as temperature differences relative to the prevailing temperature) it may be shown that the time taken for the change is given by

$$t = \frac{C}{k} (\log_e \theta_1 - \log_e \theta_2) \text{ approximately}$$

where  $k$  is a constant depending on the rate of loss of heat of the cabinet by conduction, convection and radiation. For a type of cabinet containing an inner lining which is thermally insulated from the outer case, the heat transference due to conduction and convection may be somewhat reduced, but that due to radiation is largely unaffected since the maintenance of the polished interior surfaces needed to reduce radiation would be impracticable.

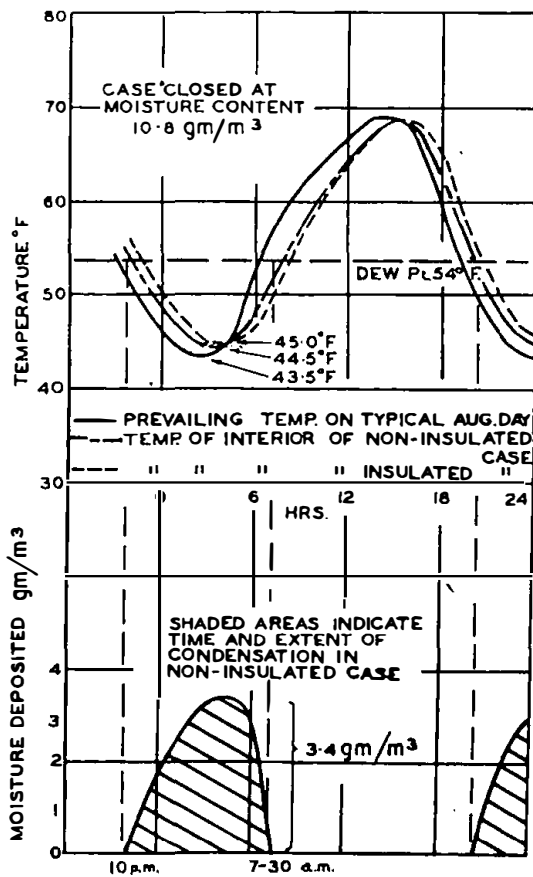

FIG. 1.—TYPICAL TEMPERATURE CURVES OF THE INTERIOR OF AN INSULATED AND UNINSULATED CABINET

The temperature of the interior of an insulated and uninsulated case is plotted in Fig. 1 in relation to variations in the prevailing temperature on a typical August day. The minimum temperatures attained, on which the amount of condensation, if any, will depend, are seen to be within about 1.0° F. of the prevailing temperature for a non-insulated cabinet and 1.5° F. for an insulated cabinet showing a negligible advantage in favour of the latter.

For any particular month, the absolute moisture content of the air is tolerably constant at all times of the day<sup>2</sup> and thus on the average the enclosed moisture content of the cabinet will be nearly constant for random opening of the cabinet. Ventilation will therefore confer no advantage in general and in fact will be a small disadvantage in that the lag in the interior temperature relative to the prevailing temperature will be reduced almost to zero on account of the circulation of air. There is further the probability of serious condensation occurring due

<sup>2</sup> "The Climate of the British Isles." E. G. Bilham.

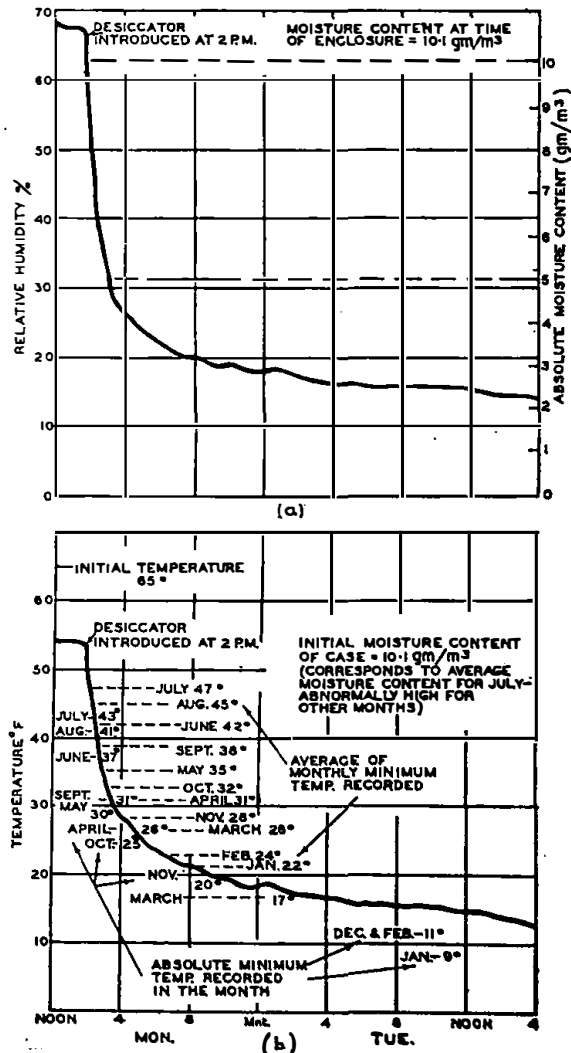

FIG. 2.—EFFECT OF INTRODUCING SILICA-GEL DESICCATORS

to the entry of warm air of high humidity impinging on the cold interior of a cabinet during the early morning.

It is possible to avoid condensation entirely by the use of suitable desiccators in a sealed cabinet. The desiccators must be so chosen and disposed within the cabinet that their rate of absorption of moisture is sufficiently rapid that, after closing the doors of a cabinet and its subsequent subjection to an extreme and sudden fall of temperature, the humidity at no time approaches 100%. The rate of lowering of the humidity of the air in a cabinet provided with six 5 oz. silica-gel desiccators is shown in Fig. 2 (a). From the connection between the moisture content of saturated vapour with temperature, a corresponding graph may be plotted of the minimum temperature at any instant so that 100% humidity shall at no time be reached (Fig. 2(b)). The graph represents closing of the doors of the cabinet under typical conditions on a July day. It is seen that the temperature could be allowed to fall to 43°F. (the minimum ever recorded in July in Britain) in approximately half an hour. A drop in temperature from 65° F. prevailing at the time of closing of the case to 43° F. in half an hour is, in this country, almost inconceivable and it may be concluded that a fall in temperature would not occur so rapidly as to cause condensation in advance, as it were, of the abstraction of moisture by the desiccator. The closing of a cabinet under conditions of 100% humidity (frequently recorded in summer months and under unfavourable winter conditions) may be similarly examined and confirmation obtained of the freedom from condensation possible with the use of suitable desiccators.

#### *Design of Cabinets.*

For average local cable networks the economical size of cabinet is one accommodating between 300 and 400 circuits. For a pillar, between 50 and 70 circuits are generally required. The standard designs have been prepared on this basis although, as later discussed, up to 800 pairs can, exceptionally, be accommodated in a standard cabinet when specially required.

External dimensions have been kept as small as possible to suit the majority of localities, particularly modern residential areas where the cabinet or pillar may be located on roadside verges, traffic islands or against low fences. Three sizes of cabinets—Nos. 1, 2 and 3—have been designed. All cabinets are 3 ft. 6 in. high and 9 in. in depth. The respective widths are 2 ft., 2 ft. 9 in. and 3 ft. 6 in. A cabinet of the intermediate size is shown in Fig. 3. The base, doors, sides, back plate, top frame and roof are separately cast in grey iron and the machined sections, after dressing with sealing compound, bolted together. The subsequent replacement of parts which may be damaged in street accidents, etc., is thereby facilitated and the use of large castings with the attendant risk of distortion and breakage avoided. The minimum thickness of castings is  $\frac{1}{4}$  in. and for rigidity and to improve

appearance the doors and back plate are dished near their edges.

The No. 2 and No. 3 sizes of cabinet are fitted with twin doors, the edges of which seat on a rubber lining recessed in a groove in the cabinet. Twin doors are used in preference to a large single door on account of increased rigidity and improved sealing. Because of its smaller dimensions the No. 1 cabinet is fitted with one door only. Doors are hinged on steel trunnions turning in gun metal bushes let into the door so avoiding the use of separate hinges attached to the framework with advantages in appearance and in ease of replacement in the event of damage. The doors are closed by two key-operated triangular-headed bolts, access to which is obtained by the movement of a hinged cover plate secured in the closed position by a Yale-type lock.

Cabinets are fixed by rag bolts to a concrete foundation set 3 in. below ground level. This permits laying the concrete foundation and positioning the conduit entries in advance of the installation of the cabinet since, until the latter is to be erected, the completed foundation can be covered and the surface around it temporarily reinstated if necessary at small cost. Advantage can, therefore, be taken of executing the foundation work of a group of cabinets at one time (even though all cabinets are not required



FIG. 3.—CROSS-CONNECTION CABINET.

immediately) and the high cost of isolated and disconnected concrete work avoided. Asbestos-cement conduit bends for receipt of the connecting cables are set in the concrete foundation, two, three or four being employed for the respective sizes of cabinet.



### Pillars.

Pillars are available in four sizes which, when in position, vary in height between 2 ft. 8 in. and 4 ft. 5 in. A 50-pair pillar is shown in Fig. 4. The outer construction is of the same general type as is used in Australia. Asbestos-cement is employed with advantages in lightness, strength, economy and permanence without the need of a preservative finish. The base which is set in the ground is circular in section and contains four apertures to allow the entry of cables from various directions. A cylindrical sleeve of asbestos cement is used to screen those apertures not in use and prevent the ingress of dirt to the interior. A layer of concrete as shown in Fig. 4 is used to protect the cables from the percolation of corrosive waters. The pillar cover, of hexagonal shape, is secured to the base by a single fixing bolt

with a triangular head to minimise interference. The bolt is so arranged that it may be inserted and screwed home from the front of the pillar which position will necessarily be accessible at all times. The cross-connection strips mounted in the form of an assembly (to be described later) are enclosed in an air-tight spring-loaded steel canister seating on a moulded rubber gasket. A segmentally shaped, detachable, self-indicating silica-gel desiccator is fixed inside the canister.

### Siting of Cabinets and Pillars.

The choice of site for a cabinet is governed by the proximity of existing plant and by wayleave considerations. Positions close up against a wall or fence will generally be suitable unless the footway is narrow. Kerb-line positions are not favoured unless stipulated by the local authority, but siting on traffic islands may sometimes be feasible if obstruction to the view of drivers of vehicles is not involved, e.g. on tree or shrub-planted islands. Cabinets may in difficult situations have to be recessed into walls or erected on private property, but this course will usually involve private wayleaves, annual payments and perhaps insecurity of tenure. However sited, reasonable and safe working conditions must be ensured. The same factors apply in the main to the siting of pillars except that, due to their smaller size, location against walls or fences, particularly in a corner or existing recess, will be preferable to erection in kerb lines where the pillar would be more conspicuous.

### Design of Flexibility Unit for use inside Buildings.

In urban areas where the telephone density is high and the facilities for the erection of street furniture restricted, a satisfactory alternative to the use of street cabinets and pillars is the erection of special units in the basements or cellars of buildings. The previous restrictions in height need not be observed and a unit of the design shown in Fig. 5 then becomes permissible. The case illustrated is of sheet steel construction basically similar to a U.A.X. case and is available in one size only of height 6 ft. 8 in., width 2 ft. 8 in. and depth 1 ft. 3 in., and accommodates an assembly incorporating 800 circuits.

The front and back of the case are detachable and are secured by wing nuts at their periphery. A suitable framework is incorporated for fixing of the assembly and provision is made for the leading in and sealing of cables at the base of the units. The case has been

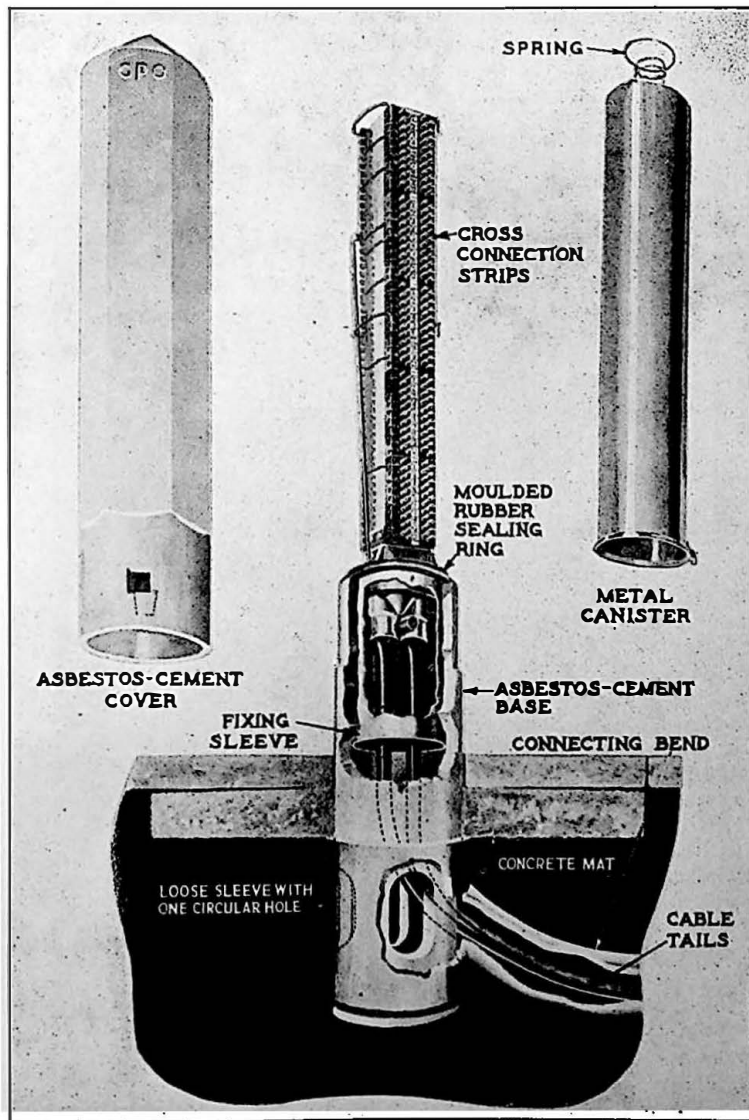

FIG. 4.—50-PAIR CROSS-CONNECTION PILLAR.

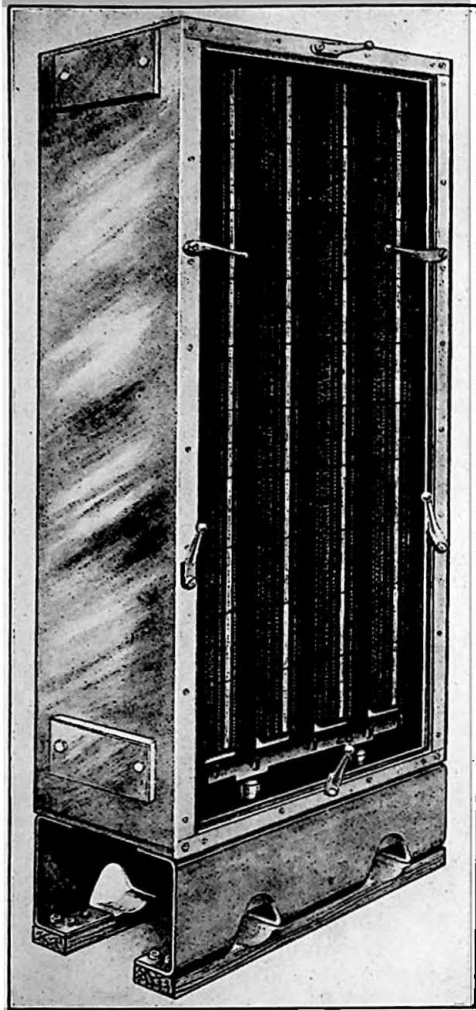

FIG. 5.—UNIT FOR USE INSIDE BUILDINGS

designed to allow the use of more than one unit side by side where increased capacity is required. Jumpers may be run between units through suitable apertures at the top and bottom of each side of the case. These apertures, when not required, are fitted with suitable covers. The base of the case is supported on feet above ground level which, when more than one unit is in use, permits the cable tails to be led away sideways underneath adjoining units. A light railing or expanded metal enclosure giving, say, two feet clearance in front of the case is desirable to prevent the storing of rubbish or other material which might otherwise restrict access.

*Use of Flexibility Units combined with Letter-boxes and with Telephone Kiosks.*

Where it is expedient to combine on the same site the functions of a flexibility point and a letter-box a combined construction may be employed. The design provides the usual requirements for the receipt of letters on one face. Two stamp machines are fitted

on an adjacent face, opposite which is incorporated a sealed section for the accommodation of the cross-connection assembly.

A standard assembly containing four vertical units may be fitted giving a capacity of 200 pairs or 400 pairs according to the type of strip employed. The combined unit is expected to be most useful where the presence of existing erections nearby, e.g. a fire-alarm post, a police box or cigarette machine, perhaps in addition to a letter-box or telephone kiosk, renders desirable the combination of more than one function in the same P.O. structure.

Similar advantages may be claimed for the combined kiosk and flexibility unit shown in Fig. 6 in which a No. 6 type kiosk has been adapted experimentally by the London Regional engineers to receive a standard assembly of 200 or 400 pairs in a sheet steel case. A specially hinged door seating on a rubber sealing strip and closed by triangular-headed bolts gives access to the assembly. The shallow projection covering the assembly at the base of the kiosk causes no inconvenience to a user of the kiosk.

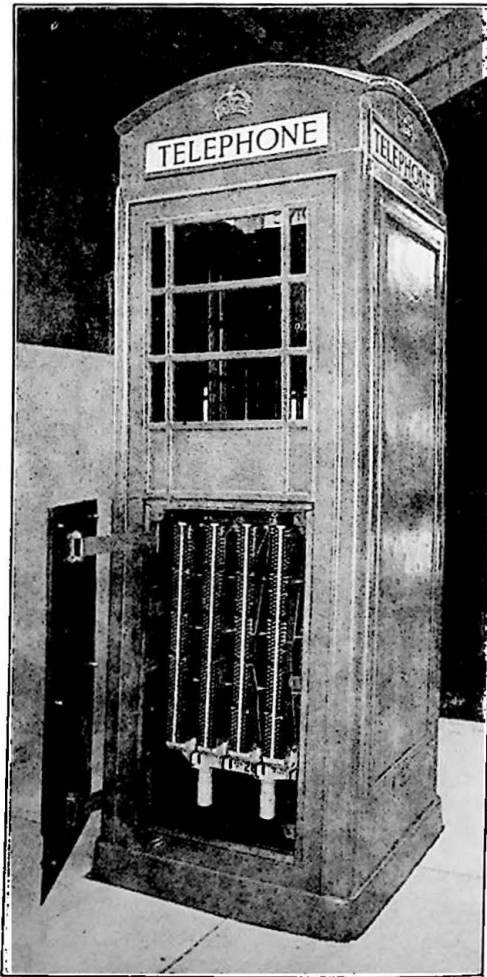

FIG. 6.—COMBINED KIOSK AND FLEXIBILITY UNIT

# The Extension of 2 V.F. Trunk Dialling Facilities

B. R. HORSFIELD, A.M.I.E.E., and  
G. R. CAMPBELL

U.D.C.621.395.342

The article describes a recent extension of 2 V.F. dialling facilities which has made possible direct dialling, by originating Zone Centre operators, to a number of automatic areas and manual exchanges beyond the distant Zone Centre terminal automatic networks. A résumé of the impinging conditions is given, and minor engineering problems encountered during the extension are briefly described.

## Introduction.

SINCE 1940 the main trunk network has been converted to automatic working by the general introduction of the 2 V.F. signalling and dialling system. During the introduction of the system, direct dialling by trunk operators was restricted to exchanges within the incoming zone centre terminal networks, but, after the initial conversion programme had been completed, war-time conditions caused attention to be directed urgently to the possibility of permitting direct dialling by trunk operators into certain exchange areas beyond the terminal networks. Wherever possible it was desired to enable the originating zone centre operator to complete each connection by dialling, without the intervention of any other operator. Where this was not possible it was desired, so far as the normal routing of trunk traffic justified, to enable the originating zone centre operator to obtain connection, automatically, with the objective manual or auto-manual exchange after dialling a numerical code.

The advantages to be obtained from the provision of the above facilities are:—

- (i) reduction in operating staff requirements,
- (ii) reduction in incoming trunk position requirements.
- (iii) increased speed of connection, resulting in a faster service for the subscriber and more efficient utilisation of trunk circuits.

War-time conditions made the speedy realisation of these advantages an urgent necessity, owing to the acute shortage of operating staff and operators' positions, and the limited number of trunk circuits available for use by the public, including important war industries, after the requirements of the fighting services, etc., had been met.

When dialling was confined to the zone centre terminal networks, impulsing conditions at the distant end were restricted to one D.C. link, not exceeding  $800\ \Omega$  resistance. The proposal to dial into automatic areas beyond the terminal networks, imposed more onerous impulsing conditions, namely dialling over D.C. links having resistances in excess of  $800\ \Omega$ , and dialling over two D.C. links, in tandem, where the objective automatic area included satellite exchanges.

The provision of dialling-out facilities to manual exchanges presented no comparable problems, as D.C. signalling junctions already existed.

## Dialling to Automatic Areas via Non-Director Type Zone Centres.

The routing of a directly dialled trunk call via a non-director zone centre to a satellite subscriber in an automatic area, other than the zone centre terminal area, is shown in Fig. 1. It is apparent that the impulses received at the satellite exchange are distorted to an extent dependent on the resultant of several factors, particularly:—

- (i) the D.C.-V.F. conversion at the outgoing zone centre,
- (ii) the transmission of the V.F. impulses over the trunk circuit,
- (iii) the V.F.-D.C. conversion at the incoming zone centre,
- (iv) the repetition by the zone centre auto-to-auto relay set (where provided),
- (v) the transmission of the D.C. impulses over junction A,
- (vi) the repetition by the main automatic exchange auto-to-auto relay set,
- (vii) the transmission of the D.C. impulses over junction B.

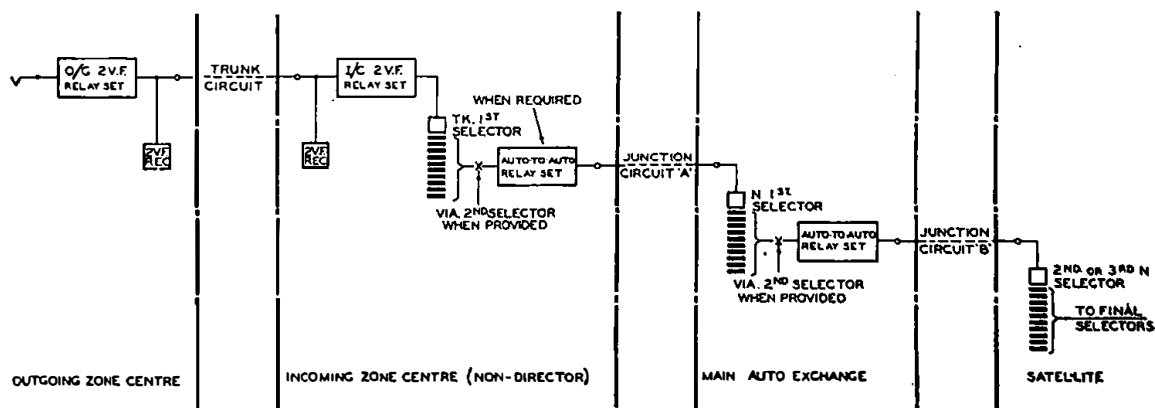

FIG. 1.—ROUTING OF DIRECTLY DIALLED CALL TO AUTOMATIC AREA VIA NON-DIRECTOR ZONE CENTRE.

It is thought that a brief description of the type of distortion introduced at each of the above stages may be of interest. In this description the term "long line" distortion refers to too long a release period of the selector impulsing relay, and "short line" distortion to too long an operate period.

(i) *D.C.-V.F. Conversion.*

In the 2 V.F. equipment at the originating zone centre, the D.C. impulses from the operator's dial are converted into V.F. impulses by a standard 3,000 type impulsing relay. This relay is controlled by the impulsing springs of the dial across which, in the operator's position circuit, a spark quench circuit is connected. The capacitance of the spark quench condenser retards the release of the relay and causes it to have an operate period which is longer than the "make" period of the dial springs. The distortion introduced at this point is, therefore, "short line" distortion.

(ii) *Transmission of V.F. Impulses.*

The V.F. impulses consist of pulses of tone transmitted during the "break" periods of the dial contacts. In general, the distortion introduced by the transmission of these signals over trunk lines, on which no fault condition exists, is very small. Echo effects may cause the tone to persist after it has been disconnected at the transmitting end, and thus prolong the "break" period of the impulses. Echo suppressors may introduce "wave front" distortion and shorten the duration of the first impulse in each train, causing an increase in "make" period of the impulse. To summarise, the distortion introduced by the trunk line is very small and may take the form of either "long line" distortion or "short line" distortion of the first impulse in each train.

(iii) *V.F.-D.C. Conversion.*

The A.C. impulses are converted into D.C. impulses in the 2 V.F. receiver. The distortion introduced by this receiver is kept to a reasonably small value over the input level range of - 12 db. to + 10 db. (ref. 1 mW in 600  $\Omega$ ) by systematic routine testing and adjustment. The impulsing performance of the receivers is adjusted to within specified tolerances and the distortion introduced by a receiver may be of the "long line" or "short line" type according to the particular adjustment.

(iv) *Repetition by Auto-to-Auto Relay Set at Zone Centre.*

Where, for reasons described later, it is necessary to fit an auto-to-auto relay set in the junction from the zone centre to the automatic area, distortion may be introduced by the relay which repeats the impulses forward over the junction. The nature of the distortion depends on the adjustments of the relay and the characteristics of the circuit in which it is connected. In the relay set under consideration, the impulsing relay is not preceded by a junction circuit and the series resistance is small. The comparatively large current resulting in the relay, and the capacitive effects of the transmission bridge condensers, tend to cause an increase in "make"

period of the impulses and, therefore, to produce "short line" distortion. Experience has shown that the magnitude of the distortion introduced by an auto-to-auto relay set at the zone centre is small. The "short line" distortion due to this relay set is worst for the first impulse in each train, since the flux in the impulsing relay reaches a maximum during the inter-train pause.

(v) *Transmission of D.C. Impulses over Junction A.*

This junction, which connects the zone centre to the objective automatic area, is often long, and may be a 2-wire unamplified or 4-wire amplified circuit; in the latter case impulsing is carried out over the phantom. Broadly, the effect of resistance in the junction is to reduce the "make" periods of the impulsing relays, and the effect of capacitance is to prolong them. The effects of line resistance and capacitance are to some extent compensatory but as the values of both characteristics become large the time-constant assumes importance, and ultimately reduces the permissible impulsing speed below the standard dial tolerances. As a generalisation it may be said that long 2-wire junctions introduce "long line" distortion and long 4-wire junctions introduce "short line" distortion.

(vi) *Auto-to-Auto Relay Set Repetition at Main Automatic Exchange.*

The distortion introduced in this relay set is determined largely by the characteristics of the junction preceding it and may therefore take the form of either "long line" or "short line" distortion. The impulsing relays in auto-to-auto relay sets carry two contact units, whereas the impulsing relays in selectors normally carry one. The auto-to-auto relay set relays therefore require a higher operating current than the selector relays and this fact may prohibit dialling to the satellite exchanges where dialling into the main exchanges is permissible. For the reasons mentioned in (iv) the "break" period of the first impulse of the relay, in each train, is shorter than that of the remaining impulses.

(vii) *Transmission of D.C. Impulses over Junction B.*

This junction, from the main exchange to the satellite, is normally a 2-wire circuit having a resistance not exceeding 800  $\Omega$ . Such junctions are usually composed of light conductors with small capacitance values, and, unless the junctions are short, the effect is to produce a small degree of "long line" distortion.

It is seen that the distortion due to (i) and (iv) is of opposite sign to that due to (vii) and these effects tend to cancel out. It may also be remarked that "wave front" distortion caused by echo-suppressors and distortion due to (i), (iv) and (vi) may all combine to produce pronounced "short line" distortion of the first impulse in each train.

Having regard to the several potential sources of impulse distortion enumerated above, the impulsing performance obtained during experimental dialling tests was remarkably good, and in the majority of tests yielding unsatisfactory results, the limiting conditions arose from causes other than overall



only 0.75 seconds it is not repeated through such a relay set.

#### *Dialling to Automatic Areas via Director Type Zone Centres.*

The routing of a directly dialled trunk call through a director zone centre to a non-director exchange is shown in Fig. 4, which should be considered in conjunction with Fig. 1. Two methods of switching

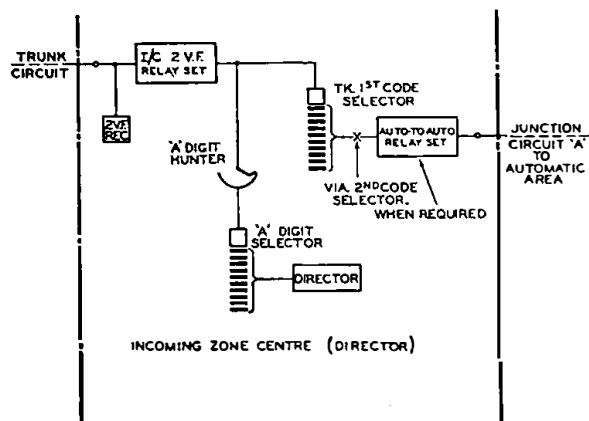

FIG. 4.—ROUTING OF DIRECTLY DIALLED CALL VIA DIRECTOR TYPE ZONE CENTRE.

at the zone centre are possible. It may be arranged that three code digits only are accepted by the director equipment, the numerical digits being dialled after the directors have become dissociated from the circuits, as indicated by the receipt of a pip of 900 c/s tone. The numerical digits are then transmitted in conditions similar to those already considered for non-director zone centres. It is of interest that tests have shown such a scheme to be satisfactory from an engineering point of view. Alternatively, by allocating three figure codes for four digit numbers and two figure codes for five digit numbers, the numerical digits may be stored in the directors which then function as impulse regenerators. The policy of storing the digits has been adopted and the remarks in the remainder of this section apply to such a scheme.

Since the directors function as impulse regenerators, any impulse distortion occurring in the 2 V.F. system is not transmitted to the subsequent D.C. links and need not be considered in determining whether a route is suitable for direct dialling. In this respect, the problems connected with dialling through zone centres of the director type are less complex than those connected with the non-director type.

The present design of director does not include the "two stage drop back" feature, referred to in the previous section, and where the resistance of the junctions from the zone centres to the automatic areas is high, it is necessary to provide auto-to-auto relay sets at the zone centres to eliminate "pick up" effects.

The director applies loop holding conditions during the inter-train pause and auto-to-auto relay sets are,

therefore, not necessary to secure correct operation of the wiper switching relays in 2,000 type areas.

Dial tone encountered during the setting up of a call by a director does not reach the trunk circuit and cannot interfere with the transmission of V.F. impulses. The first selectors at U.A.X.s Nos. 5, 6 and 12 are connected to the incoming junctions by line finder equipment and the delay which occurs during this operation, added to the hunting time of the code selector at the zone centre, may exceed the inter-train pause of the director, thus prohibiting direct dialling. In the U.A.X. No. 13 a pre-dialling path is provided while the line finder equipment is functioning and direct dialling should be possible, although the fact has not been confirmed. The inter-train pause of the director is greater than the digit absorption time of the first selector at the U.A.X. No. 14 and direct dialling into exchanges of this type is, therefore, possible; direct dialling is also possible into U.A.X.s No. 7.

#### *Dialling to Manual and Auto-Manual Exchanges.*

Connection with a manual or auto-manual exchange via a non-director zone centre, is set up directly by dialling the appropriate code. At a director zone centre the connection is set up by the director, which functions in the normal manner for a "code only" call.

Selector level circuits for dialling-out to magneto C.B.S., C.B. and sleeve control exchanges already existed and have been slightly modified for use by 2 V.F. traffic. The existing circuits provided a momentary disconnection of the backward holding earth on the P wire when the loop condition was removed during clear down. The earth was then maintained for guarding purposes until the manual exchange operator removed the plug from the incoming jack. The incoming 2 V.F. equipment provides a forward holding earth which persists for some time after the loop has been disconnected and would mask the momentary disconnection from the selector level circuit causing the selector train and trunk circuit to lock up until the plug at the manual exchange was removed. To prevent such lock-ups, the selector level circuits have been modified so that the momentary disconnection of the P-wire earth does not occur until the earth from the 2 V.F. equipment has been disconnected.

The outgoing 2 V.F. equipment incorporates a one-way transmission device to prevent extraneous noises from the operators' transmitter interfering with the V.F. signals during the setting-up of a connection. Until this device is switched out by the "answered" supervisory signal, speech conditions are not established. Thus, in order that the originating operator may pass a demand for the required number, it is necessary for the "answered" supervisory signal to be transmitted immediately the operator at the incoming manual, or auto-manual, exchange enters the circuit. This requirement necessitates segregation of the junctions carrying dialled-out trunk traffic from those carrying traffic dialled by subscribers in the local fee area, since on the local calls, to prevent premature metering, it is necessary to delay transmission of the "answered" supervisory signal until

the called subscriber is in circuit. Dialed-out trunk traffic may be combined with other operator-dialed traffic where the circuits are designed to give standard supervisory conditions.

**Conclusion.**

It has been found possible to increase considerably the dialling range of the trunk system and permit

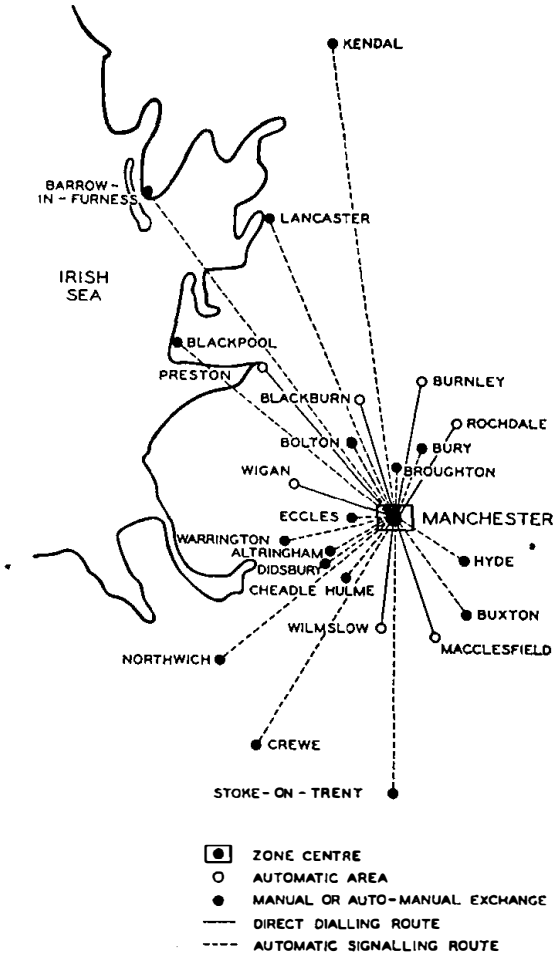

FIG. 5.—TYPICAL EXTENSION AT A DIRECTOR ZONE CENTRE.

direct dialling by trunk operators to subscribers in 34 automatic areas, many of which include satellite exchanges, and dialling-out to 152 manual and auto-manual exchanges. The number of automatic areas into which direct dialling is possible will increase continually as the conversion of manual exchanges to automatic working proceeds. Some idea of the scope of the new facilities may be formed from Figs. 5 and 6, which show the extensions at Manchester and Bristol, typical zone centres of the director and non-director types respectively.

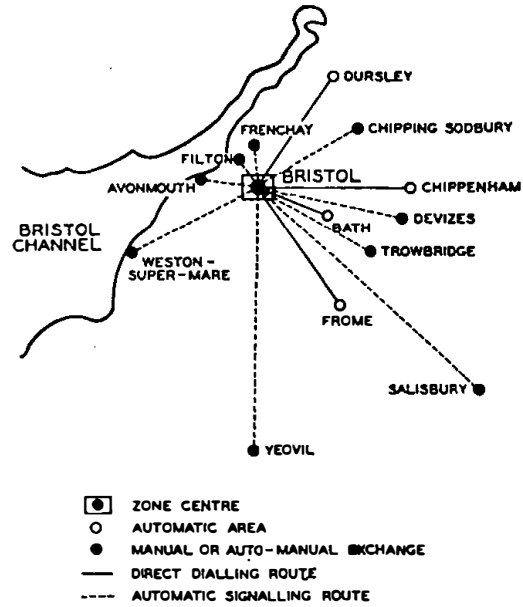

FIG. 6.—TYPICAL EXTENSION AT A NON-DIRECTOR ZONE CENTRE.

The authors wish to acknowledge the help of their colleagues in the Telephone Branch, by whom they were assisted when making experimental dialling tests, and to express their thanks to other colleagues for information supplied for use in this article. They would also like to record their appreciation of the co-operation given by exchange maintenance staffs in various parts of the country when the experimental dialling tests were in progress.

**Book Review**

"Electrical Technology for Beginners," G. W. Stubbings, B.Sc., F.Inst.P., A.M.I.E.E. 156 pp. 48 ill. E. & F. N. Spon. 6s. 6d.

This little book attempts to describe the principles of direct and alternating currents and the installation and testing of electric power supplies in a simple, non-mathematical manner. It is, therefore, of little use to students who are contemplating University or City and Guilds examinations in electrical subjects, or who intend to continue their studies in these subjects.

As with all books of this type, important detail has to be sacrificed for simplicity, and ambiguity often

results. The author's explanation of potential difference and electro-motive force, for example, is somewhat confused, so that the reader may be unable to appreciate their essential differences.

The illustrations are rather crude and do not include sufficient detail for their effective use in amplifying the text.

The attempt to introduce electrical technology by considerations of energy and power is laudable and should be adopted in text books more suitable for students.

H. R. H.

# Saturable Choke Controlled Rectifiers

U.D.C. 621.318.42

H. S. DOUBLE, B.Sc.(Eng.), A.M.I.E.E.  
(Siemens Bros. & Co., Ltd.)

Some notes on the basic principles and capabilities of this form of control for D.C. power supplies for a variety of purposes.

## Introduction.

IN the later 1920's the advent of the dry plate rectifier, the hot cathode valve of long life, and the electrolytic condenser rendered feasible the reconsideration of D.C. supply arrangements for telecommunications, railway and other signalling equipments and the maintenance of standby batteries for all purposes.

The static nature of the rectifying process emphasised the manifest advantage of static control and regulation. This led to the investigation of design and manufacturing problems involved in the use of saturable chokes. It was eventually found that this form of control would enable a large range of designs to be achieved and that the number of piece parts and materials involved in covering a large number of input and output conditions could be kept within reasonable bounds.

In the account which follows, rectifier sets intended for use without a battery will be described as "mains units," whereas those for use with a battery will be described as "autochargers." These names are applied for the sake of brevity. It will be understood that in many autochargers the main function of the rectifier set is to supply D.C. to the load, the battery merely floating. Charging in the generally accepted sense only takes place for comparatively brief periods, e.g., after a heavy load or subsequent to an A.C. supply failure.

The type of output required may be classified as:—

**Constant Voltage/Variable Current.**—This is normal for the majority of mains units, "constancy" being a somewhat elastic term, since many types of D.C. load permit of some variation in voltage.

**Constant Current/Variable Voltage.**—This is restricted to certain electro-chemical processes, e.g., off-load battery charging and electro-plating. Saturable choke control is capable of limiting the variation of current to less than  $\pm 10$  per cent. over a ten to one variation in voltage. The commercial demand for such equipments has been small.

**On-Load Battery Floating and Charging.**—This class can be subdivided into:—

(a) where the D.C. load permits a voltage variation exceeding 1.87 to 2.25 V per cell. This applies to manual and small automatic telephone exchange equipments, railway signalling equipments and many types of indicating and switching gear. It is not necessary to maintain the battery in a fully charged condition at all times, any daily discharge during "busy hour" periods being replaced during light load periods. It has been found in practice that a "quick charge" up to 2.35 V per cell, followed by a low rate of charge somewhat in excess of the rate required to replace

standing losses maintains the battery in good condition for many years provided overcharging at the low rate is avoided by not withholding the daily load cycle for more than a few days.

(b) where the D.C. load requires voltage limits not exceeding 1.87 to 2.25 V per cell. This applies to larger automatic telephone exchanges, valve amplifiers and emergency lighting where the lights are permanently connected to the battery. Obviously an approach to constant voltage/variable current is called for and the battery must be fully floated, at least up to the average value of the "busy hour" load to maintain it in a fully charged condition. Frequent A.C. supply failure involves special recharging arrangements to enable the battery voltage to be carried above 2.25 V per cell.

## Basic Principles Governing Choke Control of Rectifier Output.

The effect on the impedance of a closed iron cored choke coil of varying A.C. and D.C. ampere turns is well known. Part of a family of curves for a choke coil used with rectifiers of 1 kW output is shown in Fig. 1.

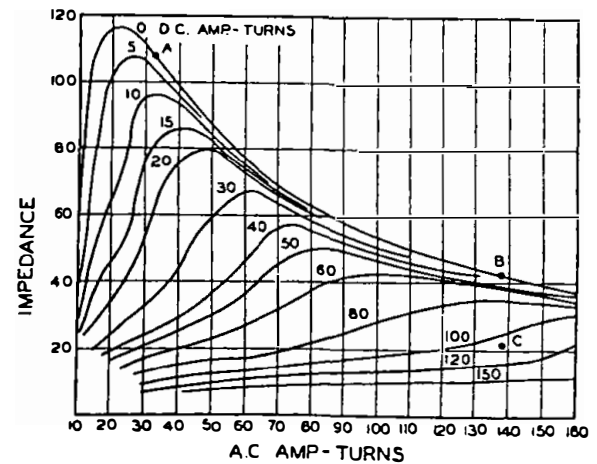

FIG. 1.—IMPEDANCE/AMPERE-TURN CURVES FOR CLOSED IRON CORED CHOKES.

Assume such a choke coil is connected between the A.C. mains and the primary of a transformer supplying a rectifier. The A.C. ampere turns will be proportional to the input current. Assume further that another winding on the same core is carrying current proportional to the D.C. output, i.e. a series winding. At no load there will be a certain (minimum) number of A.C. ampere turns. The open-circuit D.C. voltage is governed by the impedance corresponding to these A.C. ampere turns, say point A (Fig. 1). On load there will be a larger number of A.C. ampere turns, say point B. On an



A.C. ampere turn basis only there would be a fixed impedance ratio no-load to full-load. The additional D.C. ampere turns enable this impedance ratio to be increased at will, within limits, giving say, point C. It is thus possible even with rectifiers having a poor voltage regulation to cause the D.C. voltage at some given load to be equal to or bear some desired ratio to the voltage at no-load.

Similarly, by the use of voltage controlled, i.e., D.C. shunt windings, it is possible to cause the current output at one voltage to remain equal to, or bear some desired ratio to, that at some other voltage. Further the two effects can be used in combination.

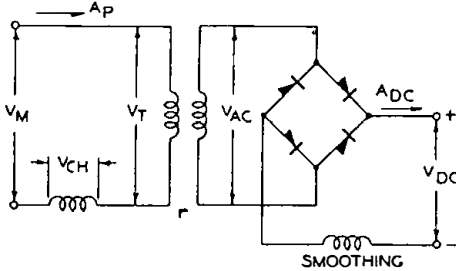

FIG. 2.—SKELETON CIRCUIT OF CHOKE-CONTROLLED RECTIFIER.

A skeleton circuit is shown in Fig. 2. Values of  $V_{AC}$  to produce the desired D.C. voltage throughout the range of D.C. output are obtained from consideration of the proposed rectifier, due allowance being made for voltage drop in smoothing chokes.  $V_T$  is then determined from the transformer ratio  $r$ . Experience has shown that  $r$  must not be made greater than  $0.85 V_M/V_{AC}$  to allow for  $V_{CH}$  still remaining with highly saturated chokes.  $A_P$  approximates to

$1.2 A_{DC}/r + j$  (magnetising current at  $V_M$ )  $V_T/V_M$ , which also gives  $\theta_1$  its angle of lag with respect to  $V_T$ .

$V_{CH}$  is then obtained by consideration of the vector diagram (Fig. 3).

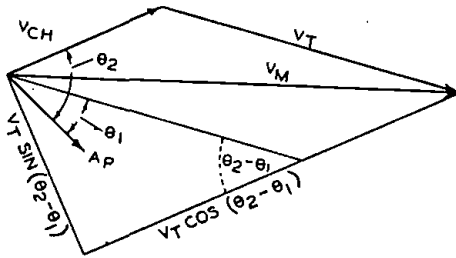

FIG. 3.

$$V_{CH} = \sqrt{V_M^2 - V_T^2 \sin^2(\theta_2 - \theta_1)} - V_T \cos(\theta_2 - \theta_1)$$

and  $Z_{CH} = V_{CH}/A_P$

Typical arrangements of the choke coils are shown in Fig. 4. The object of the duplication of the regulating chokes is prevention of induction of A.C. into the D.C. side. Quite apart from the manifest objection to this, the impedance of the A.C. windings would no longer be governed solely by the A.C. and D.C. ampere turns were a secondary A.C. allowed to flow in the D.C. windings. Furthermore,

a low resistance shunt "b" can now be used for fine adjustment of the D.C. ampere turns. The duplication also prevents non-symmetrical distortion of the current through the A.C. windings.

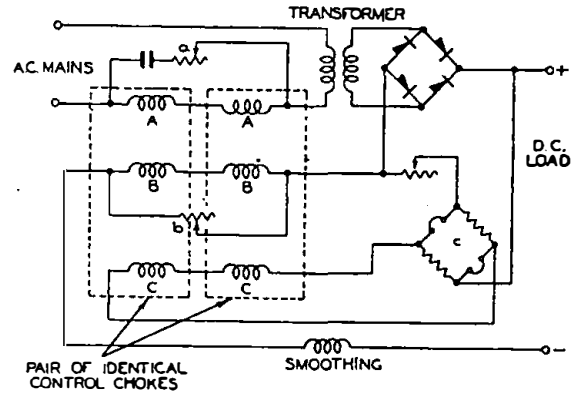

FIG. 4.—TYPICAL CONNECTIONS OF CHOKE WINDINGS.

Some approach to constant voltage/variable current output can be achieved by series D.C. windings B only. Similarly, an approach to constant current/variable voltage can be achieved by shunt D.C. windings C connected direct to the D.C. side of the rectifier via a series resistance for the purpose of adjustment of the ampere turns.

Constant voltage attainment is brought nearer by the connection of a condenser in series with a resistance "a" across the pair of A.C. windings. The reactance of the condenser approximates to  $1/Z_{CH}$ ,  $Z_{CH}$  being the impedance of the choke at the point of maximum discrepancy between the desired values of  $Z_{CH}$  and the values given by the employment of series D.C. ampere turns to equalise no-load and full-load terminal voltages. The resistance "a" is introduced to control the rise in impedance to the desired amount.

Another direction in which improvement is secured is by the addition of shunt windings C connected via a voltage sensitive network "c." The latter is a barretter bridge balanced at or about the desired output voltage. Tendency for this voltage to rise is counteracted by a current through the winding C in such a direction as to result in a reduction of the total D.C. ampere turns. Tendency for the voltage to fall has the reverse effect. This output voltage control has the further action of minimising the effect of A.C. supply voltage fluctuations. If it is desired to retain certain predetermined output voltage limits the barretter bridge is then connected via a suitable small transformer and rectifier to the A.C. terminals and serves to compensate for mains voltage fluctuation, without restricting the output voltage variation.

The output curve for autochargers is obtained by a preliminary design for equal voltages at no-load and three-quarters-load on the basis of series D.C. ampere turns only. The dip in the curve can be produced by the shunt condenser method, the capacitance being calculated for resonance at the frequency of the mains with the choke impedance at the A.C. and D.C. ampere turns concerned. Alternatively,

a shunt D.C. winding can be used connected to oppose the series winding and bring the D.C. ampere turns to zero at the desired point.

*Some Examples of Units now in Service.*

*Mains unit used on magneto exchange V.F. signalling equipment rack (Fig. 5).*—The circuit em-

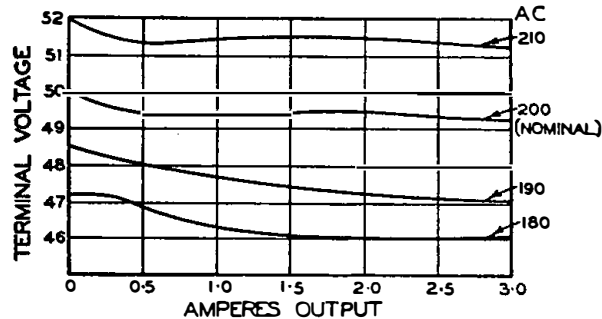

FIG. 5.—MAINS UNIT USED ON V.F. SIGNALLING EQUIPMENT RACK.

ployed closely follows Fig. 4, the chief variation being that the shunt resistance "b" is made inductive. The reason is that while the D.C. load is in process of changing from one value to another the induced voltage across the smoothing chokes would be large enough to cause fluctuations in D.C. voltage beyond what would ensue with a static load. The inductive shunt "b" causes a temporary excess change in D.C. ampere turns restricting such fluctuations.

It will be noted that the voltage sensitive circuit "c" has restricted the effect of the +5 per cent. -10 per cent. A.C. voltage fluctuation to the required extent, viz., to maintain D.C. voltage limits of 46 to 52.

*Autochargers.*—By employing a circuit similar to Fig. 2 but without shunt D.C. windings and their associated equipment output curves as shown in

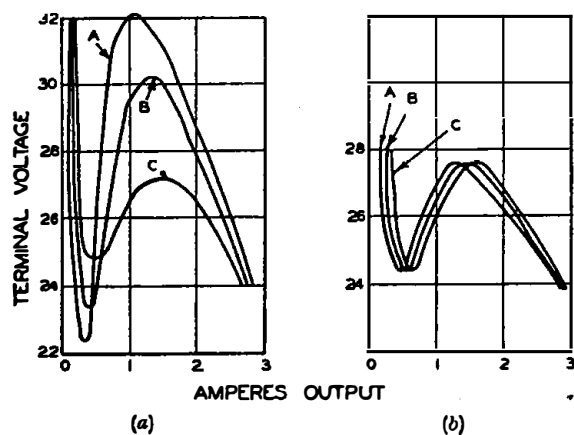

FIG. 6.—AUTOCHARGER OUTPUT CURVES.

Fig. 6 (a) are obtained. Curve A is obtained by making "b" (Fig. 4) large and "a" small. Curve C is obtained by making "b" small and "a" large. The curves illustrate the flexibility of saturable choke control in dealing with a large number of output requirements besides providing adjustments

for rectifier ageing. By the same means the same chokes are made to serve for a number of input variations, e.g., 100 to 120 V, 200 to 260 V with frequency varying from 25 to 100 c/s. The transformer has two primaries and these and the A.C. windings of the chokes are respectively in parallel for 100 to 120 V inputs and respectively in series for 200 to 260 V working.

In Fig. 6 (b) curve A is obtained with a small condenser and large resistance "a"; curve C with a large condenser and small resistance.

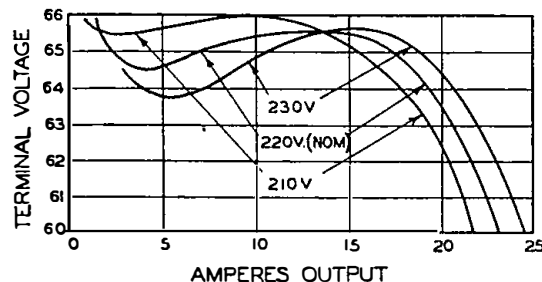

FIG. 7.—AUTOCHARGER TO FLOAT 29-CELL BATTERY.

Fig. 7 shows the output curves of an autocharger incorporating a hot cathode valve used to float a 29-cell battery between 63 and 66 V until the load approaches 20 A, when the output voltage is made to droop to avoid overloading the valve (rating 25 A).

In this autocharger the voltage sensitivity of the circuit associated with the shunt D.C. windings of the chokes was increased by the insertion of a choke and series condenser so designed that a rapid variation of current through the network "c" (Fig. 4) ensues as the A.C. voltage varies about its mean value.

*Continuous heavy loads.*—Certain cases arise where the load is continuous and very nearly constant, e.g., some types of railway signalling equipment. The standby battery may be restricted to a capacity such that it will only supply the load for, say, five hours. Consequently the battery has to be floated continuously to provide for a load in excess of the normal charge rate. A further increase in current beyond this has to be provided for recharging at a reasonably high rate after an A.C. supply failure, while still supplying the load.

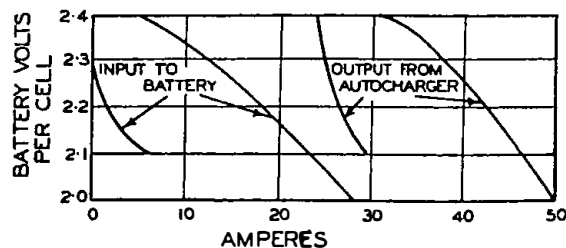

FIG. 8.—AUTOCHARGER FOR BATTERY WITH CONTINUOUS 25A LOAD.

Fig. 8 illustrates the output curve of one of these special autochargers supplied to float a 200 Ah battery continuously loaded at approximately 25 A. This result is achieved by paralleling a choke controlled rectifier with an uncontrolled one.

### Advantageous Features of Saturable Choke Control.

The advantages of saturable choke control may be summarised as:—

(i) The cost is small compared with the cost of the complete rectifier equipment.

(ii) owing to the absence of contacts, switches,

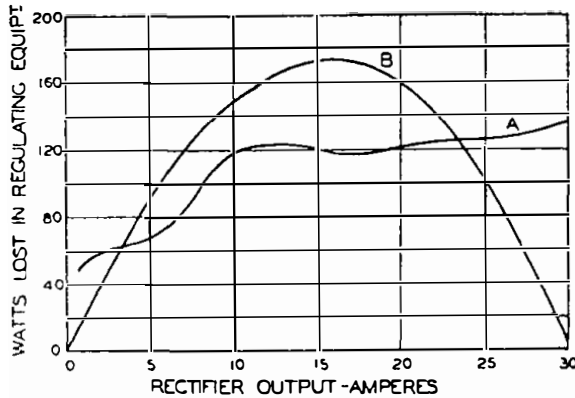

FIG. 9.—LOSSES DUE TO VOLTAGE REGULATION.

## Book Review

"Handbook of Technical Instruction for Wireless Telegraphists." H. M. Dowsett, M.I.E.E., F.Inst.P., and L. E. Q. Walker, A.R.C.S. 8th Edition. Iliffe & Sons, Ltd. 668 pp. 618 ill. 30s.

A text-book which has had continued popularity for 32 years and passed through eight editions must have merits. It has, however, changed considerably through the years and it is difficult to recognise in this modern work the old friend of one's youth.

It is interesting to turn back to the first edition of this work by J. C. Hawkhead, published in 1914, and to compare it with the present edition. The first edition of 295 pp. was in three parts, the first of ten chapters dealing with fundamentals of electricity and magnetism, the second part of two chapters dealing with electromagnetic waves and the receiving circuit, and the final section of five chapters dealing with working equipment manufactured by the Marconi Company. The sending apparatus in those days was of course spark, the commonest ship set being the  $1\frac{1}{2}$  kW, a wonderfully reliable piece of equipment. The larger ships' set was of 5 kW rating. As standby a 10 in. induction coil was provided. For reception the Marconi Multiple Tuner and Magnetic Detector was used. A small power set with rotary discharger of  $\frac{1}{2}$  kW rating was also described, and a brief mention made of a receiver using the Fleming diode as detector. Nothing is said about direction finding which was then impracticable owing to the low sensitivity of receiving gear.

The present edition consists of thirty-two chapters and, besides being a useful and up-to-date text-book on electricity and magnetism, electrical technology and thermionics, also covers most types of marine radio equipment manufactured by Marconi's Wireless Telegraph Company and Messrs. Siemens Bros. Besides descriptions

commutators, etc., no mechanical deterioration is possible.

(iii) The power losses remain low over the whole range of output.

Fig. 9, curve A shows the measured choke losses in a 50 V 30 A autocharger used to float a 24 V cell battery between 50 and 53 V up to 25 A drooping to 48 V at 30 A. The losses are seen to compare favourably with those shown in curve B, which indicates the losses incurred by the introduction of the necessary C.E.M.F. cells or resistance regulator between a battery (connected to a straight rectifier) and the D.C. bus bars to achieve the same voltage regulation. Curve B does not include the energy consumption necessary for the automatic control of such forms of regulation.

During the past 10 years between two and three thousand mains units and autochargers incorporating saturable choke control have been put into service. This has involved upwards of 200 different output and input requirements. This experience has confirmed that the basic principles and the way in which they are applied are such as to permit of a high degree of standardisation in manufacture in spite of the wide range of requirements.

of sending and receiving equipment of normal types, separate chapters describe short-wave aeriels and apparatus, marine direction finders, marine sound reproduction equipment, distress call apparatus, lifeboat and emergency outfits and trawlers' apparatus. The book well demonstrates the wide range of equipment now used for marine communication and navigation purposes. The descriptions of apparatus are clear with numerous circuit diagrams and illustrations.

One or two minor discrepancies were noticed however, e.g. on page 206 the No. 341 set is stated to be worked on 200 c/s, while on page 208 the transformer of this set is rated at 800 c/s.

In dealing with echo-sounders the natural wavelength of the piezo electric projector is given as a length in metres which in fact is not the true wavelength but the quotient of the velocity of light divided by natural frequency of the projector. As the projector does not produce aetheric waves these figures have no relation to the actual wavelengths produced in water by the projector and are liable to confuse the reader. The same thing occurs on page 339 where the natural resonance of a magneto striction resonator is given as 18,700 c/s or 16,000 metres approximately. A little lower it is stated that at 18,700 metres the water wavelength works out at 8 cm.—presumably metres here is a misprint for c/s.

The present authors, however, have made a good job of their task and this new edition contains a tremendous mass of useful information both theoretical and practical.

It will be a useful guide and compendium to wireless operators and to engineers dealing with marine equipment.

A. J. G.

# How Negative Feedback Operates

C. A. A. WASS, B.Sc., A.M.I.E.E., A.Inst.P.

U.D.C. 621.395.645.34

A simple exposition showing by numerical and pictorial examples how the application of negative feedback improves the performance of an amplifier.

## Introduction.

IT is well known that the application of negative feedback can be made to improve the performance of an amplifier in almost every respect, and a number of articles dealing with both the theoretical and practical aspects of the subject have been published.<sup>1, 2</sup> Instead of the purely mathematical approach it is interesting and instructive to examine the changes in the various voltages, currents, and waveforms which occur when negative feedback is applied to the amplifier.

## Reduction of Non-Linear Distortion.

As an example of the way in which negative feedback reduces non-linear distortion consider the amplifier shown in Fig. 1 (a). When the input to the amplifier is a pure sine-wave with a peak value of one volt, as shown at A, it is supposed that every positive half-cycle is amplified 100 times, but every negative half-cycle is amplified only 50 times. The output wave at B thus consists of a half-cycle of sine-wave with peak value 100 V followed by a half-cycle of sine-wave with peak value of 50 V. Practical amplifiers often suffer from distortion of this kind, although usually the difference between positive and negative half-cycles is not so marked and there is no sharp bend where the curve crosses the axis.

Now let a network of resistances, etc., called the feedback network, be connected across the amplifier output terminals as indicated in Fig. 1 (b), the input impedance of the network being high enough to prevent appreciable shunting of the amplifier load impedance. Other details of this network are unimportant for the present purpose, but suppose that its effect is to reverse the phase of a voltage passing through it and to give an output voltage at C equal to  $\beta$  times the voltage at B, the value of  $\beta$  being 0.08. Then when a positive half-cycle of 100 V peak followed by a negative half-cycle of 50 V peak appears at B, a negative half-cycle of 8.0 V peak followed by a positive half-cycle of 4.0 V peak will appear at C. To apply the negative feedback let C be connected to D so that the voltage at E is equivalent to the voltage at A combined with the voltage at C. Obviously, the voltage at E will now be different from its former value, and the output voltage at B and the feedback voltage at C will be different from the values shown in Fig. 1 (b). To maintain the output voltage at 100 V on the positive peaks it will be necessary to increase the input voltage, and when this has been done the new conditions will be as in Fig. 1 (c). The new conditions

in this and other cases can be found without difficulty by normal mathematical methods or by trial and error, but a description of the procedure is outside the scope of this article. It is sufficient for the present to ensure that the various voltages and currents shown are in accordance with the usual laws governing electric circuits. Thus, the output wave at B now has a positive half-cycle of 100 V peak followed by a negative half-cycle of 90 V peak, and hence the voltage wave at C has a negative peak of 8.0 V followed by a positive peak of 7.2 V. Since the positive and negative parts of the wave at C are both parts of sine-waves the feedback voltage at C can easily be combined with the input wave at A by taking the algebraic sum of the peak voltages. The result of the combination is the wave shown at E, having a positive half-cycle of 1.0 V peak followed by a negative half-cycle at 1.8 V peak, and when these two half-cycles are amplified 100 times and 50 times respectively the output wave will be shown at B.

Fig. 1 demonstrates two important results of the application of negative feedback. First, the amplifier gain is reduced, since a much larger input is needed to give about the same output; and second, the distortion is reduced, since the output wave is a more faithful reproduction of the input wave.

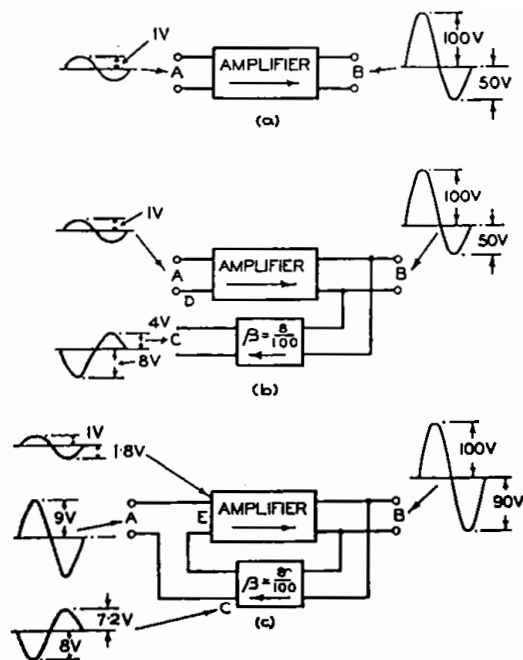

FIG. 1.

<sup>1</sup> *Elec. Eng.*, Vol. 53, p. 114.

<sup>2</sup> *B.S.T.J.*, Vol. 19, p. 421.

### Reduction of Hum.

In Fig. 2 (a) the amplifier has a voltage gain of 100 times, and it gives a sine-wave output of 100 V peak with an input of 1.0 V peak. Owing to inadequate smoothing an asymmetrical wave of  $x$  V peak is fed along the H.T. supply leads, giving an output of 10 V peak. In practice, of course, the hum and the signal would combine to form a single wave, but it is more convenient, and quite legitimate, to show them separately. In Fig. 2 (b) negative feed-

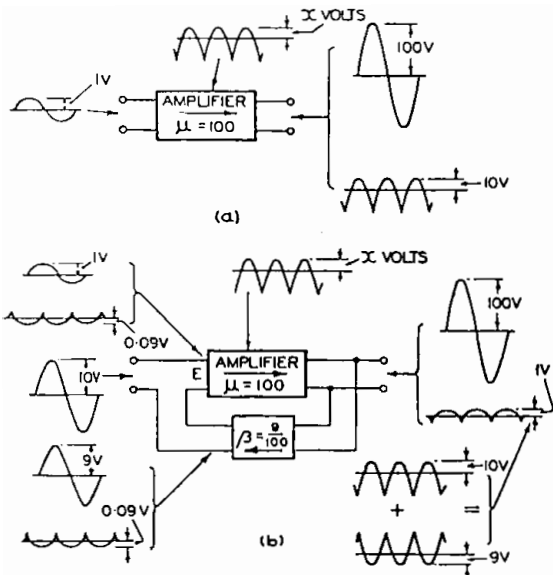

FIG. 2.

back has been applied using  $\beta = 0.09$ , and the input voltage has been raised to restore the sine-wave output voltage to 100 V peak, while the asymmetrical wave is injected at the same level as before. Following the method of Fig. 1 it will be seen that at E there will be a sine-wave of 1.0 V peak plus an inverted asymmetrical wave of 0.09 V peak. The sine-wave output will clearly have a peak value of 100 V, but the asymmetrical wave will give an inverted wave of 9.0 V peak which will combine with the original 10 V wave to give a wave of only 1.0 V peak. Thus, negative feedback has reduced the hum to one tenth of its former value, at the expense of a ten-times reduction in gain.

Instead of the asymmetrical hum-wave any other wave introduced within the amplifier could be treated by the method of Fig. 2. For example, the wave might be second harmonic produced by the output stage of the amplifier, and it would be reduced in exactly the same way as the hum. In this way Fig. 2 may be used as an alternative to Fig. 1 to demonstrate the reduction of non-linear distortion.

### Change of Input Impedance.

In Fig. 3 (a) the amplifier has a voltage gain of 100 times and its input impedance is  $10,000 \Omega$ , represented by a resistance across the input terminals. When the output voltage is 100 the input voltage is

1.0 and the current flowing in the input impedance is 0.1 mA. In Fig. 3 (b) negative feedback has been applied, with  $\beta = 0.09$ , causing the output to fall to 10 V. In the input circuit the input voltage and the feedback voltage oppose each other so that the voltage across the  $10,000 \Omega$  resistance is only 0.1 and the current flowing is 0.01 mA. Viewed from the terminals at A an input of 1.0 V gives a current of 0.01 mA, so the input impedance now appears to be  $100,000 \Omega$ . If the input voltage is raised to 10 V so as to restore the output to 100 V the current in the input circuit will be increased to 0.1 mA, and the impedance will still appear to be  $100,000 \Omega$ .

The feedback arrangement shown in Fig. 3 and

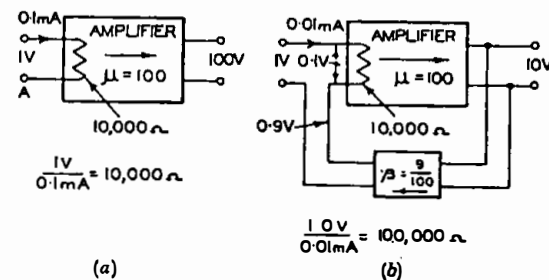

FIG. 3.

in all other diagrams is for so-called "voltage" feedback, because the voltage fed back is directly proportional to the voltage at the output. With other arrangements it is possible to make the impedance smaller instead of larger, and the output impedance can be increased or decreased in a similar way.

### Reduction of Change of Gain.

The amplifier of Fig. 4 (a) has negative feedback

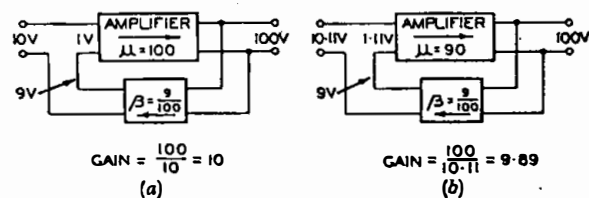

FIG. 4.

applied with  $\beta = 0.09$ , so that its effective gain is reduced from 100 times to 10 times. If the gain of the amplifier itself falls for some reason from 100 times to 90 times and the input voltage is raised to restore the output voltage to its former level the new conditions will be shown as in Fig. 4 (b). Thus, although the gain of the amplifier itself has fallen by 10 per cent. the overall gain of the amplifier with negative feedback has fallen by only 1.1 per cent. This effect is independent of the cause of the reduction of gain, which may be ageing of valves, lower H.T. voltage, etc. There is a corresponding stabilising action against increase of amplifier gain.

### Effect of Different Phase-Shift.

In all the foregoing examples it has been assumed that a reversal of phase, i.e., a phase-shift of  $180^\circ$ , occurs in the  $\beta$  circuit and that no phase-shift occurs

in the amplifier. From the feedback point of view it is immaterial whether the phase-shift occurs in the  $\beta$  network or in the amplifier or in both, provided the total phase-shift has a suitable value. It is not necessary for this value to be exactly  $180^\circ$ , in fact, provided the degree of feedback is fairly large, variations of as much as  $90^\circ$  above or below the nominal  $180^\circ$  have little effect on the reduction of distortion and hum. In the case of variation of gain, however, the value of phase-shift is of great importance, and this point seems to have been so much overlooked that it appears justifiable to refer to it here, although a numerical example is necessarily less simple than those used in the previous sections.

In Fig. 5 (a) the amplifier has feedback with

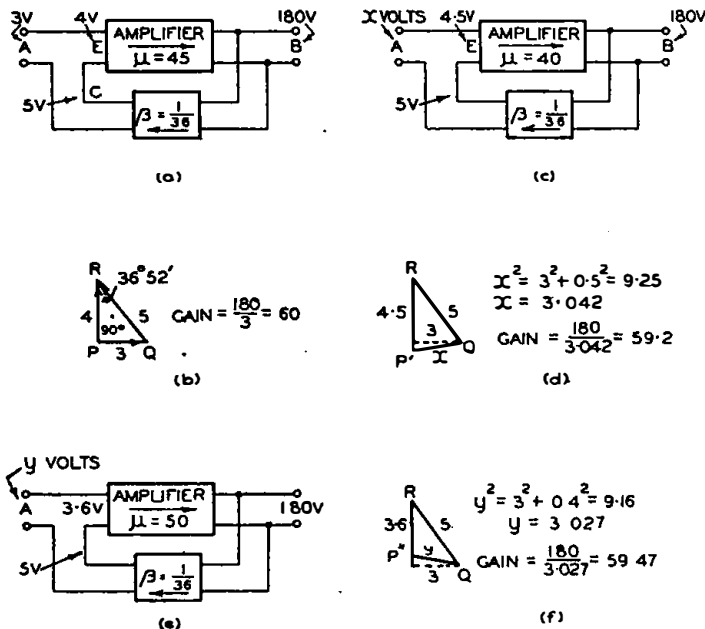

FIG. 5.

$\beta = 1/36$ , and the total phase-shift through the amplifier and  $\beta$  network is  $36^\circ 52'$ . The reason for choosing this particular value will appear shortly. The voltage at E is 4.0, and this can be represented by the line PR, four units long, in Fig. 5 (b). The voltage at C is  $4 \times 180 \times 1/36 = 5.0$  V, and this can be represented by QR, five units long. The phase-difference of  $36^\circ 52'$  between these two voltages can be represented by making angle PRQ equal to  $36^\circ 52'$ . The cosine of this angle is 0.8, which is equal to PR/QR, and hence triangle PQR is right-angled at P. The length of the third side PQ is therefore three units, and the input voltage at A must be 3.0 volts. The conditions shown in Fig. 5 are therefore self-consistent, and might reasonably be expected to occur in an amplifier of suitable design.

Now suppose the gain of the amplifier falls from 45 to 40 times and the input voltage is raised to restore the output voltage to 180. The feedback voltage is still 5.0 V, whereas the voltage at E must

be 4.5 V. To find the new voltages at A another voltage triangle is used, as shown in Fig. 5 (d). The feedback voltage is the same as in Fig. 5 (b), so QR can be drawn immediately. The voltage at E is now 4.5 V and the phase-shift is the same as before, so RP' can be drawn 4.5 units long, making angle QRP' equal to angle QRP. The input voltage is represented by P'Q, and is easily shown to be 3.042 V. Thus, although the gain of the amplifier itself has fallen by 11.1 per cent. the overall gain of the amplifier with feedback has fallen by only 1.4 per cent. If the amplifier gain  $\mu$  had fallen by a smaller amount the overall change of gain would have been relatively smaller; for example, if  $\mu$  had fallen by 5.55 per cent. to 42.5 the overall gain would have fallen by only 0.35 per cent.; and for very small changes in  $\mu$  the overall gain is independent of  $\mu$ .

If  $\mu$  is made greater instead of smaller the interesting result is obtained that the voltage at A, represented by P'Q in Fig. 5 (f), still has to be greater than 3.0 V to restore the output voltage to 180, so that although  $\mu$  has risen by 11.1 per cent. the overall gain has fallen by 0.9 per cent. These results are rather surprising, especially as examination of Figs. 5 (a), 5 (c) and 5 (e) shows that the application of feedback has had the effect of increasing the amplifier gain in all three conditions.

The conditions shown in Fig. 5 have been chosen to emphasise the importance of phase-shift in connection with change of gain and would not be encountered in a feedback amplifier of normal design. However, in an amplifier which, without feedback, gave a large change of gain for a given supply variation, but was satisfactory in other respects, it would be possible to improve the gain stability over a narrow frequency range without decreasing the overall gain by applying feedback in the manner of Fig. 5. Wide-band

amplifiers cannot be treated by this method owing to the difficulty of maintaining the required phase conditions over a wide range of frequencies.

In all amplifiers in which the degree of feedback approaches the theoretical limit there is a frequency, usually above the working band, at which the overall gain is independent of small changes in  $\mu$ , and above this frequency there is a range in which the overall gain rises as  $\mu$  falls and vice-versa.

#### Conclusion.

It will be observed that in the foregoing examples the application of feedback has left the amplifier itself entirely unaltered. This is an important point in connection with what may be called the "mechanism" of feedback, and it helps to explain, for example, why the power-handling capacity of an output stage is not appreciably increased by the application of feedback. It also throws some light on the problem of optimum load for the output stage of a feedback amplifier.

# Comité Consultatif International Téléphonique

## Meetings in Paris, June and July, 1946

U.D.C. 061.3 : 621.395

A brief account of matters discussed and decisions reached by the C.C.I.F. Sub-Commissions dealing with various aspects of transmission.

A NUMBER of meetings of Commissions and Sub-Commissions of the C.C.I.F. were held in Paris from 17th June to 6th July, 1946. These were arranged at the London meeting in November, 1945, to deal with urgent questions. Some of these questions were outstanding at the outbreak of war and to these new questions had been added. Several commissions discussed tariff and operating procedure, but it is proposed not to deal with these. At the London meeting the old Signalling Sub-Commission was upgraded and now reappears as the "8th C.R."

### 1. *Transmission.*

A sub-commission of the 3rd C.R. dealt with a very large programme of urgent questions under the chairmanship of Mr. R. M. Chamney (Great Britain). Many of these questions related to wide band transmission and had been discussed by the Sub-Commissions in December, 1938<sup>1</sup>. It has now been agreed to recommend the widening of the limits of the attenuation frequency curve of an international circuit. This has been found necessary where more than one carrier system comprise the link. A number of agreements were made on 12- and 24-channel amplifiers and on terminal equipments. The general questions of assembly of super-groups has been agreed except for Super Group No. 1, where certain nations wish to adopt the American frequency allocation (68-308 kc/s). This matter is to be thrashed out later in the year. A frequency difference of  $\pm 2$  c/s (audio/audio) will henceforth be permitted on international circuits provided on wide band systems.

On the question of transmission of television a most useful exchange of views was made. It is likely that a large quantity of coaxial cable will be laid on the Continent of Europe in the next few years, and a considerable amount of technical information has been included to give administrations guidance as to how spare pairs may be adapted to television transmission. These items include steady state equalisation of attenuation and phase, noise and non-linearity. A new question for study regarding check of characteristics by transmission of pulses has been suggested. Members of the committee witnessed very interesting demonstrations of 800 and 1000 line television.

Coaxial cable has already been mentioned, but a very comprehensive agreement was reached between all the countries concerned to use coaxial pairs of external diameter 0.370 in., similar to the type standardised by the British Post Office.

The widening of the band width of international circuits has led administrations to agree in future that international calls will be routed on national plant having similar characteristics. This, of course,

cannot be put into effect immediately, but it may affect the weight of loading used in this country in the future.

Wide band, open wire systems are becoming common in certain countries and this was reflected in an agreement to use the 4 kc/s spacing of channels and one of the primary groups at present laid down for wide band cable work (12-60 kc/s or 60-108kc/s).

The main work of the sub-committee of the 4th C.R. for specification of quality of transmission was concerned with plans for bringing into effect as early as possible an international standard for limits of transmission for international telephone calls, based on measurements or calculations of effective transmission, to replace the present standard, which is based on measurements of volume (loudness). To this end the sub-committee made specific recommendations to the 4th C.R. covering details of a reference circuit for use at the S.F.E.R.T. laboratory as a common standard for comparison, a method of comparing the standard with a circuit under test by articulation tests and a method of evaluating a rating in db. (to be used as the effective transmission rating of the circuit) from these articulation tests. The sub-committee proposed that a series of such tests be carried out at the S.F.E.R.T. laboratory on working standards of the different telephone administrations and that the results of these tests be studied with a view to confirming the method as acceptable as a standard for the purpose and, if this is agreed, deciding the new effective transmission limits to be laid down.

### 2. *Maintenance.*

This was the first meeting of the Maintenance Sub-Commission to be held since the war and was very useful in enabling maintenance engineers of all countries to discuss maintenance problems of the post-war era. The Chairman was M. Visser (Holland). The matters specifically on the agenda and discussed were:—

- (a) The procedure for lining up and maintaining international 12-circuit groups. Before the war there were no international 12-circuit groups and consequently no procedure had been agreed. Since the war, however, a number of these groups have been placed in service and more are foreshadowed in the immediate future. The problem, therefore, was one of considerable urgency. The procedure to be followed, of course, depends upon the possibility of standardising testing points and testing equipment and this question was discussed before the 3rd Commission de Rapporteurs. No final decisions were taken by the 3rd C.R.; it was therefore agreed by the Maintenance

<sup>1</sup> P.O.E.E.J., Vol. 32, p. 52.

Sub-Committee that, pending directions from the 3rd C.R., an interim scheme should be tentatively agreed. Great Britain had submitted a proposed scheme for lining up and maintaining international groups and, with minor modifications, it was agreed by all countries present that the proposals of Great Britain should be followed.

- (b) The revision of maintenance instructions on audio circuits was also considered in view of the changes in types of equipment which have been brought about in the last ten years and proposals were put forward for the revision of the international hypsogrammes to bring them in line with modern practice.
- (c) Owing to the fact that international circuits had all been ceased during the war and had been provided on an urgent basis since the war, the official programme of routine tests no longer applies. Each country therefore submitted its proposals regarding the dates and times desired for such tests and these were circulated for further discussion at the next meeting of the Sub-Committee.
- (d) A further item discussed was the international numbering of circuits of various types. Since the war, international private wires have been used considerably; these and the many other types of circuits called for a revision of the methods of numbering such circuits internationally. The proposals of Great Britain were discussed at length and it was agreed to submit them to all countries for further discussion at the next meeting.

### 3. Signalling.

Questions of signalling used to be dealt with by a permanent sub-commission, but the subject has become so extensive that a new C.R. has been created, and matters relating to signalling will henceforth be dealt with by the "8th C.R."

The 8th C.R. met under the chairmanship of Mr. Holmbladt (Denmark) and a number of far-reaching decisions were made. Further consideration of the proposals and recommendations in Tome 1 Ter<sup>2</sup> have resulted in a completely new set of proposals for the automatic setting up of calls over trunk circuits, with the object of saving line time. For instance, it is suggested that coded pulses transmitted from a keysender or register will be employed for setting up international calls. To facilitate such mechanisation each administration is recommended to introduce a national numbering scheme. No

\* Reunions d'Oslo, 1938.

details of the new system have been agreed, but the following general principles will be adhered to:—

- (a) All signals will be standardised for transmission over international circuits. Audible signals which present difficulties due to variation of characteristics in different countries will be converted into standard international signals and reconverted at the distant *tete de ligne* into appropriate national tones or signals.
- (b) The signalling frequencies to be used on international lines will be determined as a result of tests for signal imitations and of the permissible signal level at different frequencies. This question will be studied jointly with the 3rd C.R.
- (c) The question of echo suppressors is to be re-studied with the 3rd C.R.
- (d) Alternative routing is to be the exception.

### 4. Protection.

Joint meetings of the 1st and 2nd C.R.'s were held from the 3rd to 5th July, at which representatives of the electric power, gas and railway international bodies were present. All the existing questions for study were considered and an exchange of views took place on practically all of them. It is worth noting that it was decided to recommend that further consideration should be given to the question of revising the directives on the matter of maximum permissible voltage induced in telephone lines under short-circuit conditions on the power line. In this connection it was agreed:—

- (a) That it is not logical to introduce in the calculations the factor of 0.7 which is at present used to relate the A.C. component of the initial transient short-circuit current to the steady state fault current and
- (b) That there may be good reason for increasing the present value of 300V for the maximum permissible induced voltage to 400V.

The question of H.V. D.C. transmission was considered by all to be very important and one which should be fully considered in conjunction with the appropriate Study Committee of the C.M.I.

The members of the 1st and 2nd C.R.'s attended those meetings of the C.I.G.R.E. (High Tension Conference) at which papers on telephone interference and corrosion were under discussion.

Advantage was taken of the presence in Paris of the representatives of the various interested international bodies to hold a meeting of the C.M.I. Mr. Marshall, of the Central Electricity Board, was elected President and the vacancies among the president rapporteurs were filled.



# Notes and Comments

## Roll of Honour

The Board of Editors deeply regrets to have to record the deaths of the following members of the Engineering Department :—

*While serving with the Armed Forces.*

Birmingham Telephone Area	Beary, W. F. ..	Unestablished Skilled Workman	Flight Sergeant, R.A.F.
Birmingham Telephone Area	Hartley, H. H. ..	Unestablished Skilled Workman	Flight Sergeant, R.A.F.
Birmingham Telephone Area	James, D. V. ..	Unestablished Skilled Workman	Pilot Officer, R.A.F.
Bradford Telephone Area ..	Eglen, R. ..	Skilled Workman, Class II ..	Flight Sergeant, R.A.F.
Canterbury Telephone Area	Cairns, J. D. ..	Unestablished Skilled Workman	Sergeant, R.A.F.
Canterbury Telephone Area	Harris, A. E. ..	Labourer ..	L/Sgt., Queen's Royal Regiment
Chester Telephone Area ..	Morris, W. E. ..	Skilled Workman, Class II ..	Signalman, Royal Signals
Engineering Department ..	Ede, A. J. ..	Unestablished Skilled Workman	Flying Officer, R.A.F.
Engineering Department ..	Edwards, J. A. ..	Unestablished Skilled Workman	Warrant Officer, R.A.F.
Engineering Department ..	Paice, S. O. ..	Motor Mechanic. . . . .	Sergeant, R.A.S.C.
Leeds Telephone Area ..	Wright, G. H. ..	Unestablished Skilled Workman	Flying Officer, R.A.F.
Liverpool Telephone Area ..	Churchill, T. ..	Unestablished Skilled Workman	Sergeant, R.A.F.
Liverpool Telephone Area ..	Mawdsley, J. R. ..	Unestablished Skilled Workman	A.C., Class II, R.A.F.
London Telecoms. Region ..	Blackwell, A. H. J. ..	Skilled Workman, Class II ..	Corporal, Royal Signals
London Telecoms. Region ..	Blunden, C. M. ..	Unestablished Skilled Workman	Signalman, Royal Signals
London Telecoms. Region ..	Burn, A. R. ..	Unestablished Skilled Workman	Flight Sergeant, R.A.F.
London Telecoms. Region ..	Burton, E. C. ..	Unestablished Skilled Workman	Ldg. Airman, Fleet Air Arm
London Telecoms. Region ..	Manson, W. J. A. ..	Skilled Workman, Class II ..	Corporal, Royal Signals
London Telecoms. Region ..	Prince, E. J. ..	Unestablished Skilled Workman	Warrant Officer, R.A.F.
London Telecoms. Region ..	Raymish, D. ..	Labourer. . . . .	Signalman, Royal Signals
London Telecoms. Region ..	Reynolds, J. S. L. ..	Unestablished Skilled Workman	Flight Sergeant, R.A.F.
London Telecoms. Region ..	Somerville, H. J. ..	Unestablished Skilled Workman	Flight Sergeant, R.A.F.
London Telecoms. Region ..	Spalding, L. W. . . . .	Skilled Workman, Class II ..	Corporal, Royal Signals
London Telecoms. Region ..	Strachan, J. P. . . . .	Unestablished Skilled Workman	Flight Sergeant, R.A.F.
London Telecoms. Region ..	Sutherland, G. G. ..	Labourer. . . . .	Private, Highland Light Infantry
London Telecoms. Region ..	Teasdale, W. J. ..	Skilled Workman, Class I ..	Corporal, Royal Signals
Manchester Telephone Area	Harper, A. ..	Skilled Workman, Class II ..	Signalman, Royal Signals
Newcastle-on-Tyne Telephone Area	Snaith, W. E. N. ..	Unestablished Skilled Workman	Sub.-Lieut., R.N.

## Recent Awards

The Board of Editors has learned with great pleasure of the honours recently conferred upon the following members of the Engineering Department :—

Birmingham Telephone Area	Bristow, W. B. ..	Skilled Workman, Class II	Lance Corporal, Royal Signals	Mentioned in Despatches
Birmingham Telephone Area	Carter, J. A. ..	Skilled Workman, Class II	Flight Lieutenant, R.A.F.	Distinguished Flying Cross
Birmingham Telephone Area	Finch, H. R. ..	Skilled Workman, Class II	Corporal, Royal Signals	Mentioned in Despatches
Birmingham Telephone Area	Howarth, N. J. ..	Skilled Workman, Class II	Sergeant, R.A.F.	Mentioned in Despatches
Bournemouth Telephone Area	Smallwood, W. G. ..	Skilled Workman, Class II	Captain, Royal Signals	Member of the Order of the British Empire
Bradford Telephone Area ..	Ingham, J. ..	Skilled Workman, Class II	C.Q.M.S., Royal Signals	Mentioned in Despatches
Bristol Telephone Area ..	Seymour, W. H. ..	Skilled Workman, Class II	Major, R.E.M.E.	Mentioned in Despatches
Colchester Telephone Area. .	Baldwin, R. W. ..	Skilled Workman, Class II	Sergeant, Royal Signals	Mentioned in Despatches
Colchester Telephone Area. .	Kerry, F. B. ..	Skilled Workman, Class II	L/Sergeant, Royal Signals	Mentioned in Despatches

Coventry Telephone Area ..	Spanton, D. N.	Unestablished Skilled Workman	Sergeant, Royal Signals	Mentioned in Despatches
Edinburgh Telephone Area..	Adams, J. T. ..	Skilled Workman, Class II	Sergeant, Royal Signals	Mentioned in Despatches
Edinburgh Telephone Area..	McEwan, E. ..	Skilled Workman, Class I	Signalman, Royal Signals	Twice Mentioned in Despatches
Edinburgh Telephone Area..	Macpherson, C. J.	Skilled Workman, Class II	Signalman, Royal Signals	British Empire Medal
Engineering Department ..	Argent, J. S. ..	Mechanic ..	Armourer Q.M.S., R.E.M.E.	Mentioned in Despatches
Engineering Department ..	Ball, H. ..	Mechanic ..	W.O., Class I, R.E.M.E.	Mentioned in Despatches
Engineering Department ..	Brown, G. ..	Mechanic-in-Charge, Grade I	A.S.M., R.E.M.E.	Mentioned in Despatches
Engineering Department ..	Coates, G. H., M.B.E.	Executive Engineer	Major, Royal Signals	Mentioned in Despatches
Engineering Department ..	Curtis, P. W. C.	Unestablished Draughtsman	Signalman, Royal Signals	Twice Mentioned in Despatches
Engineering Department ..	Dibsdall, A. T. D.	Inspector ..	Major, Royal Signals	Member of the Order of the British Empire
Engineering Department ..	Graham, G. E...	Skilled Workman, Class I	Lt.-Col., Royal Signals	Member of the Order of the British Empire and Mentioned in Despatches
Engineering Department ..	Kirby, H. K. ..	Executive Officer	Lieutenant, Royal Signals	Mentioned in Despatches
Engineering Department ..	Lomax, H. ..	Mechanic ..	W.O., Class II, R.E.M.E.	Mentioned in Despatches
Engineering Department ..	North, G. W. ..	Inspector ..	Lieutenant, Royal Signals	Mentioned in Despatches
Engineering Department ..	Patch, J. D. ..	Clerical Officer ..	Gunner, R.A. ..	Mentioned in Despatches
Engineering Department ..	Pearson, E. J. ..	Clerical Officer ..	Flight Lieutenant, R.A.F.	Distinguished Flying Cross
Engineering Department ..	Stonebanks, A. M., M.B.E.	Asst. Engineer ..	Lt.-Col., Royal Signals	Knight Officer of the Order of Orange Nassau, with Swords (Netherlands)
Engineering Department ..	Weatherstone, E. C.	Skilled Workman, Class II	Flight Lieutenant, R.A.F.	Distinguished Flying Cross
Engineering Department ..	Wilkinson, E. H., M.C.	Asst. Engineer ..	Major, Royal Signals	Mentioned in Despatches
Glasgow Telephone Area ..	Burns, B. S. ..	Skilled Workman, Class II	Major, Royal Signals	Member of the Order of the British Empire and Mentioned in Despatches
Lancaster Telephone Area..	McKnight, J. B.	Skilled Workman, Class II	Lieutenant, Royal Signals	Mentioned in Despatches
Leeds Telephone Area ..	Burton, R. N. ..	Inspector ..	Major, Royal Signals	Mentioned in Despatches
Leeds Telephone Area ..	Conboy, J. ..	Skilled Workman, Class II	Signalman, Royal Signals	Mentioned in Despatches
Leicester Telephone Area ..	Elliott, E. J. ..	Skilled Workman, Class II	Sergeant, Royal Signals	Military Medal
Liverpool Telephone Area ..	Kettle, W. J. ..	Unestablished Skilled Workman	Signalman, Royal Signals	Mentioned in Despatches
Liverpool Telephone Area ..	Turner, F. J. ..	Skilled Workman, Class II	Flight Sergeant, R.A.F.	Mentioned in Despatches
London Telecoms. Region ..	Chambers, E. H.	Labourer ..	Corporal, Royal Signals	Mentioned in Despatches

London Telecoms. Region ..	Griffith, D. A. C.	Inspector ..	Lt.-Col., Royal Signals	Mentioned in Despatches
London Telecoms. Region ..	Griffith, W. H. C.	Skilled Workman, Class II	Captain, Royal Signals	American Bronze Star
London Telecoms. Region ..	James, L. R. ..	Asst. Engineer ..	Major, Royal Signals	Mentioned in Despatches
London Telecoms. Region ..	Rosser, V. W. ..	Labourer ..	L/Corporal, Worcester Regt.	Military Medal
London Telecoms. Region ..	Slater, R. ..	Skilled Workman, Class II	Captain, Pioneer Corps	Mentioned in Despatches
Manchester Telephone Area	Quinn, A. E. ..	Skilled Workman, Class II	C.S.M., South Lancs. Regt.	Mentioned in Despatches
Middlesbrough Telephone Area	Brand, J. E.	Skilled Workman, Class II	L/Sergeant, Royal Signals	Distinguished Conduct Medal
Newcastle-on-Tyne Telephone Area	Lucas, F. N. ..	Area Engineer ..	Lt.-Col., Royal Signals	Mentioned in Despatches
Preston Telephone Area ..	Smith, A. E. S.	Skilled Workman, Class I	Sergeant, Royal Signals	Mentioned in Despatches
Shrewsbury Telephone Area	Eckley, S. J. T.	Skilled Workman, Class II	Corporal, Royal Signals	Mentioned in Despatches
Southend-on-Sea Telephone Area	Carter, S. W. ..	Skilled Workman, Class II	Sergeant, Royal Signals	Twice Mentioned in Despatches
Southend-on-Sea Telephone Area	Chisman, S. H.	Inspector ..	Captain, R.E.M.E.	Mentioned in Despatches
Southend-on-Sea Telephone Area	Hensey, E. H. ..	Skilled Workman, Class II	Ldg. Telegraphist, R.N.	Distinguished Service Medal
Southend-on-Sea Telephone Area	Wyndham, R. ..	Skilled Workman, Class II	Corporal, Royal Signals	British Empire Medal
Swansea Telephone Area ..	Wilkins, J. J. ..	Skilled Workman, Class II	Sergeant, Royal Signals	Mentioned in Despatches

#### Birthday Honours.

The Board of Editors offers its sincere congratulations to the following members of the Engineering Staff who have been honoured by H.M. the King in the Birthday Honours List:—

Aberdeen Telephone Area ..	Johnston, N. ..	Skilled Workman, Class I ..	British Empire Medal
Belfast Telephone Area ..	Hicks, C. J. ..	Chief Inspector ..	British Empire Medal
Dundee Telephone Area ..	Dye, R. J. ..	Inspector ..	British Empire Medal
Engineering Department ..	Anderson, F. ..	Chief Inspector ..	British Empire Medal
Engineering Department ..	Blackstaffe, H. P.	Executive Engineer ..	Member of the Order of the British Empire
Engineering Department ..	Dickson, F. (Miss)	Superintendent of Typists ..	Member of the Order of the British Empire
Engineering Department ..	Norman, E. N. ..	Skilled Workman, Class I ..	British Empire Medal
Engineering Department ..	Walmsley, T. ..	Staff Engineer ..	Commander of the Order of the British Empire
London Telecoms. Region ..	Scammell, E. A. ..	Skilled Workman, Class I ..	British Empire Medal
London Telecoms. Region ..	Thorpe, W. R. ..	Draughtsman, Class I ..	British Empire Medal
Manchester Telephone Area	Pickles, J. ..	Skilled Workman, Class I ..	British Empire Medal
Midland Region ..	Speight, A. ..	Chief Regional Engineer ..	Companion of the Imperial Service Order
Swansea Telephone Area ..	Jenkins, W. H. ..	Skilled Workman, Class I ..	British Empire Medal

#### Correspondence

*Editor, P.O.E.E.J.*

Sir,—In the article by J. M. Allan (July, 1946) the author describes a method of locating a cable fault when no good wire is available. This method is not new, having been described by W. Graf in *Telegraphen und Fensprech Technik*, 1934. It was investigated by the British Post Office in 1940 and some practical trials were made.

To overcome the inaccuracy due to use of two meters which have differing calibration errors, one can add a variable resistance (R) to the shorter loop until both meters, previously checked in series, indicate

the same current. Then, if the meters are equal in resistance and  $r$  = single-wire resistance per mile, the distance  $X = L/2 - R/4r$ .

The test is difficult if there are fluctuating stray currents arising from the fault, or if the fault resistances are high, but it certainly has the advantage of simplicity in comparison with bridge methods such as the Poleck test, which was tried at the same time.

The Poleck test, however, can be used over a wide range of line and fault conditions, and requires no expert co-operation at the far end.

Yours, etc.,

8th August, 1946.

A. C. TIMMIS.

**Mr. B. O. Anson, O.B.E., M.I.E.E.**

We regret to have to record the death of Mr. B. O. Anson on 6th August, 1946.

Mr. Anson had a distinguished career in the Post Office; he entered as a Sorting Clerk and Telegraphist in 1896, and during his 42 years' service rose to the rank of Assistant Engineer-in-Chief. He will be remembered largely for his part in the introduction of automatic telephone exchange working, but he was also intimately concerned in many other matters particularly those relating to the welfare of the staff.



He served for many years on the Council of the Institution of Post Office Electrical Engineers and on the Board of Editors of this JOURNAL, of which he was Chairman for 12 years. The success achieved by the JOURNAL during his tenure of office was largely due to his energetic and wise guidance.

After leaving the Post Office in 1938, Mr. Anson did not retire from active life. He took first a post

in the Ministry of Home Security where he was responsible for equipping the N.F.S. with the necessary fire fighting appliances. Then in May, 1940, he became Manager of the Beeston Works of Ericsson Telephones Ltd., and tackled with his characteristic energy and foresight the enormous problem of converting the output of this large factory to war-time production. He continued in this post until his untimely death.

Mr. B. O. Anson will be affectionately remembered by a large circle of co-workers in the telecommunications industry both in this country and abroad, many of whom have benefited from his wide experience and sound advice.

**Mr. J. D. Taylor**

John Dean Taylor, who retired from the post of Superintending Engineer, Edinburgh, in 1931, passed away in Leeds on 4th May, 1946, at the age of 74.

Mr. Taylor entered the Post Office as a boy messenger in Leeds, where he secured established rank as a sorting clerk on 24th February, 1889. His aptitude for clerical work soon led to his transfer to the staff of the Superintending Engineer there, followed by promotion to a First-Class Clerkship at Cardiff on 30th December, 1893. At an early date he had become interested in the practical work of the Engineering Branch, which led him to undertake a course of technical study, and in 1897 he was appointed to an engineership at Manchester.

The following years saw him undertaking pioneer work in connection with the installation of switchboards for the newly acquired trunk line system and for the London local telephone service.

In 1910 he was selected to take charge of one of the "Inventory Groups" formed in connection with the impending purchase of the National Telephone

Company's plant throughout the country and, on completion of the work of the "Groups" and of duties arising out of the valuation, he was promoted in November, 1912, to the Superintending Engineership of the Scotland East district, with headquarters at Edinburgh, where he remained until his retirement at the age of 60.

Mr. Taylor was a man of outstanding integrity and singleness of purpose; of wide interest in the activities of the staff under his control; and of deep sympathy for those who, by reason of ill-health or domestic conditions, were in trouble or distress. His qualities earned him the respect of all with whom he came in contact and the affectionate regard of those who were privileged to learn more of the man himself.

J. W. A.

**Printed Papers**

A few copies of the following Printed Papers published by the Institution of Post Office Electrical Engineers since the outbreak of war are available for sale at the price shown plus threepence for postage:—

No. 173. "Audio-Frequency Ripple from D.C. Power Supplies in Communication Engineering."

H. R. Harbottle, B.Sc., D.F.H., M.I.E.E., J. A. Sheppard, B.Sc., A.M.I.E.E., and D. L. Richards, B.Sc., 1939 1s.

No. 174. "Metallurgy and Communications." E. V. Walker, B.Sc., A.R.S.M. 1940 6d.

No. 175. "Telephone Exchange Power Plant Development Trends and War-time Problems." W. J. Marshall. 1941. 1s.

No. 177. "Recent Applications of the Quartz and X-ray Spectrographs to Post Office Problems." R. Taylor, M.A., Ph.D., B.Sc. 1941. 1s.

No. 179. "Introduction of U.A.X. Multimetering in the Leeds Area." H. G. Cope. 1941. 1s.

No. 180. "Subscribers' Cable Distribution—Some Further Considerations." F. Summers, A.M.I.E.E. 1944. 1s.

No. 181. "Post-War Exchange Design." H. E. Francis, A.M.I.E.E. 1943. 1s.

No. 182. "London Inland Trunk Services." W. H. Scarborough, A.M.I.E.E. 1943. 1s. 6d.

No. 183. "Frequency Modulation." J. H. H. Merriman, M.Sc., A.Inst.P., A.M.I.E.E., and R. W. White, B.Sc., F.Inst.P., A.M.I.E.E. 1945. 1s. 6d.

No. 184. "The Fundamentals of Direct Current Impulsing in Multi-Exchange Areas." S. Welch, M.Sc.(Eng.), A.M.I.E.E. 1944. 1s. 6d.

They may be obtained from The Librarian, The Institution of Post Office Electrical Engineers, G.P.O. (Alder House), London, E.C.1.

Printed Papers Nos. 176 and 178, dealing respectively with Transformers for Telecommunications and Long Distance D.C. Impulsing, were also published during the war but these are now out of print.

**Binding**

Large increases in the cost of labour and material have made it necessary to increase the charges for binding the JOURNAL. In future the cost for binding (including the supply of covers) will be 7s. 6d. per volume. The price of the cover sold separately will be 2s.

## Regional Notes

### London Telecommunications Region

#### MEADWAY AUTOMATIC EXCHANGE

Meadway automatic telephone exchange was brought into service on the 22nd August, 1946. This was installed as a Second Unit on Speedwell exchange and is located in the same building. The equipment, which consists of 2,900 multiple, was installed by Standard Telephones and Cables Ltd.

In addition 29 manual board positions were provided and have been brought into use, which will cover the manual board requirements of both Speedwell and Meadway exchanges.

The power plant, which is common to both exchanges, has been increased by the addition of 1,400 amp. generator and the two main batteries have each been increased to 2,100 amp./hrs. capacity to meet the additional Meadway load.  
E.R.S.

### North Eastern Region

#### WHITBY EXCHANGE TRANSFER

The last magneto exchange in the Middlesbrough Area disappeared when the transfer to C.B.10 took place at Whitby at 1 p.m. on June 19th, 1946. Disappeared was the right word in this case—the whole of the old exchange equipment was cleared out of the building by 8 p.m. on the day of transfer, and despatched in containers for the depot the following day. This hurry was necessary to allow a partition to be taken down during the night, and thus give the exchange operators room to be seated when operating the new switchboard. Whitby had been scheduled for auto, but the intervention of the war, with its building restrictions, etc., ruled this out. The position was therefore reached where the 20 year old 4-position 600-line magneto exchange had to be replaced without further delay.

The only accommodation available was the telegraph instrument room adjacent to the old exchange room. At first consideration it seemed impossible to contain a 9-position C.B. 10 exchange, equipped with 1,000 subscribers multiple, but by facing the new positions to the partition between the old and new exchanges, leaving a space of less than 2 ft., sufficient room was found to house all equipment less meters and monitors desk; these had to be fitted in the space vacated by the old exchange.

It is believed that the transfer arrangements were novel. First consideration was to a complete external teed joint scheme, but owing to manhole congestion, etc., it was decided to use internal tie cables. The method used was to reproduce the whole of the exchange side of the old M.D.F. on strip connections on the line side of the new M.D.F., temporary jumpers being used between these and tails on the permanent jumpers. The result was that all U.G. cables, etc., were recovered from the old M.D.F. prior to transfer, thus making the way clear for the quick removal of the old exchange, which was so essential in this case. The transfer involved 41 junctions and 547 subscribers' lines, and in spite of a thunderstorm during changeover, the transfer only fell short of 100 per cent. by two subscribers' line faults and one minor exchange fault.

A. C.

### Scottish Region

#### DAMAGE TO TELEPHONE PLANT BY SNOW

During the war years Scotland West Area was fairly free from serious breakdowns due to snowstorms, but unfortunately this condition has not been maintained in peace time, for on the night of 8/9 March, 1946, a sudden

snowstorm in the Solway Valley in the south of Scotland occurred which left in its trail miles of wrecked overhead telephone routes. Fortunately the storm was not general and was in fact confined to a strip of country approximately 35 miles long and 10 miles wide. It struck the Solway coast near Kirkcudbright and continued in a north-easterly direction centring on the town of Dumfries and the surrounding districts where most of the damage occurred. A curious feature of the storm was the almost complete absence of wind and the snow being of the soft clinging variety; damage was entirely due to sheer weight of snow accumulating on the wires, and affected plant was in low altitudes only. In fact plant in areas higher than 250 feet above sea level was not affected to any extent. Approximately 12 inches of snow fell in about eight or nine hours and in that short space of time considerable damage was done. Two hundred and eighty-two poles were broken, 2,000 miles of wire were broken or stretched beyond repair, 871 poles were swayed and 400 stays, mostly light ones, were broken or stretched. Twenty five exchanges were isolated, 100 junctions out of commission and over 1,000 subscribers' lines were faulty.

The storm repair organisation was put into operation immediately and a temporary headquarters was set up at Dumfries under the direction of a Chief Inspector. A welfare officer was appointed whose duties were to obtain lodging for a comparatively large number of additional workmen, and thereby saving workmen time in searching for lodgings. Three additional Survey Officers were also appointed to assess the damage and compile the data for permanent repairs.

M. McL.

#### SERVICE DIFFICULTIES—TEMPORARY ARRANGEMENTS AT LOHCARRON

In many parts of Scotland telephone service is still given from small manual exchanges, sometimes referred to irreverently as "back bedroom" exchanges. Despite increasing age and often ill-health the Caretaker Operators gave loyal service throughout the war years, but since the crisis has passed there has been a succession of cases in which removal of the exchange at short notice has been necessary. Usually these are capable of treatment on standard lines, for instance, by conversion to automatic working or the installation of a new manual switchboard in other premises.

Service difficulties were recently experienced at Lochcarron, a C.B.S.2 exchange parented on Kyle, a Group Centre in the Aberdeen zone. A mobile U.A.X. could not be made available, it was not possible to delay the removal until a U.A.X. site could be obtained, the building erected and the equipment installed, and no one could be found in the locality prepared to take an exchange and give service.

Dependent on Lochcarron was a C.S.X. at Achnashellach; terminated on Lochcarron was an omnibus call office circuit, in part single wire, running out as far as Applecross 14 miles away. Kyle is 16 miles away and the road journey involves a ferry crossing at Struan. The unusual expedient was adopted of meeting the immediate emergency by serving the subscribers at Lochcarron from the sleeve control manual board at Kyle. The busier and more important lines were given direct circuits; other subscribers were put on as two party lines with code ringing. For this purpose pairs in a M.U. cable were utilised. Overhead junctions thrown spare were used to re-parent the C.S.X. equipment and to take back the omnibus circuit. Local battery telephones were, of course, retained. Signalling, beyond the usual limits, is satisfactory.

L. G.

# Institution of Post Office Electrical Engineers

## Additions to the Library

- Recent additions to the Library include the following :
- 1684 *British Timbers.*** Boulton and Jay (British 1946).  
A reference book detailing and illustrating all the most important of the British timbers, their qualities and uses.
- 1685 *Radio Waves and the Ionosphere.*** T. W. Bennington (British 1944).  
This is not a textbook and contains no mathematics, but merely aims to explain in simple language the role of the ionosphere in long distance short wave communication. It includes chapters on ground waves and sky waves—the sun and the ionosphere—how the ionosphere is sounded—ionosphere variations—long distance transmission—ionosphere disturbances and other abnormalities.
- 1686 *Electromagnetic Waves.*** S. A. Schelkunoff (American 1943).  
A textbook and work of reference. It contains basic theoretical information on radiation, wave propagation, wave guides and resonators, and those engaged in theoretical research will find a stock of equations which may serve as a starting point for further investigation—covers also vectors and co-ordinate systems—maths. of oscillations and waves—Bessel and Legendre functions—impedors, transducers, networks, transmission theory—radiation and diffraction and antenna theory.
- 1687 *Textbook of the Materials of Engineering.*** H. F. Moore (American 1941).  
A concise presentation of the physical properties of the common materials used in structures and machines together with descriptions of their manufacture and fabrication. The text is distinctly elementary in character.
- 1688 *Electric and Magnetic Fields.*** S. S. Attwood (American 1942).  
Covers the electrostatic fields—magnetostatic and ferromagnetic fields of simple geometrics—electrostatic polarisation and induction—electric current—solution by method of images—space charge, Laplace and Poisson equations—mapping electric fields—energy and forces in condensers and in an inductance.
- 1689 *Radio Technology.*** B. F. Weller (British 1946).  
This book assumes a certain fundamental knowledge of electricity and magnetism and some acquaintance with the principles of A.C. It provides a good technical background with a practical bias. Transmitters and receivers are given equal space and the subject of aerial feeder systems adequately treated. Covers radio engineering—the production of damped radio frequency oscillations by the discharge of a condenser through inductance and resistance—thermionic valves—valve as power amplifier—transmitters for radio—radio telephonic transmission—principles of reception—the supersonic heterodyne—aerial systems and radiation.
- 1690 *Installation and Maintenance of Electric Motors.*** E. Molloy (British 1940).  
The installation and maintenance of electric motors of all types is covered in this book, ranging from fractional horse powers to several hundred horse power. A feature of special interest is the large number of starter wiring diagrams included.
- 1691 *Science Abstracts—Physics*** (from January, 1946).
- 1692 *Science Abstracts—Electrical Engineering*** (from January 1946).
- 1693 *The Behaviour of Slow Electrons in Gases.*** Healey and Reed (Australian 1941).  
A reference book—the investigations described deal with the determination of such quantities as the mean free paths, average energy losses and probabilities of attachment, of electrons moving through a gas with energies not exceeding a few electron volts. The presentation is sufficiently complete to prove of value to the general physicist and to physics students in the final years of a Degree course.
- 1694 *This Changing World.*** Brumwell (British 1945).  
A series of contributions by some leading thinkers to cast light upon the pattern of the modern world.
- 1695 *Principles and Practice of Heating and Ventilating.*** Molloy (British 1945).  
Fundamentals of heat transmission discussed—covers the important components of modern heating and ventilating systems and various electrical heating and warming appliances—automatic temperature control—thermal insulation—air conditioning, with practical notes on estimates, specifications and running costs.
- 1696 *Fundamentals of Electric Waves.*** Skilling (American 1942).  
Helpful to the radio engineer in acquiring a background for understanding antenna arrays, transmission lines, waveguides, reflectors and resonators.
- 1697 *Mathematics of Modern Engineering—Vol. II (Mathematical Engineering).*** Keller (American 1942).  
An introduction to the methods of mathematical engineering by the analysis of discrete physical systems. Covers engineering dynamics and mechanical vibrations—tensor analysis of stationary networks and rotating electrical machinery—non-linearity in engineering.
- 1698 *Introduction to the Theory and Design of Electric Wave Filters.*** F. Scowen. (British 1945).  
“A useful aid to the student and designer in the approach of this rather specialised subject.”—A. J. Gill, Deputy E.-in-C.
- 1699 *Radar.*** Hallows (British 1946).  
Radiolocation simply explained.
- 1700 *Modern Plastics.*** Barron (British 1945).  
A complete and comprehensive survey by one of the most experienced technicians in the handling of thermoplastics.
- 1701 *The Measurement of Colour.*** Wright (British 1944).  
A comprehensive but concise account of the principles and methods of colour measurement and specification. Visual and photo-electric instruments are described as well as the relation of colour physics to many technical processes.
- 1702 *Fields and Waves in Modern Radio.*** Ramo and Whinnery (American 1944).  
An extensive treatment of field and wave theory from the radio engineer's point of view. The most important objectives were the treatments of high frequency circuits, skin effect, and shielding problems, problems of wave transmission and reflection, transmission lines and waveguides, cavity resonators and antennas and other radiating systems, and to correlate fields and waves

with circuits so that they are all seen as parts of a consistent whole. This is a textbook for students who have had the usual engineering maths. course through the calculus, but not necessarily vector analysis or extensive courses in differential equations.

1703 *Electric Discharge Lamps*. Cotton (British 1946).

For the illuminating engineer and physicist. Fundamental principles involved in light production discussed and various kinds of lamps in present use described with their construction and operating characteristics.

1704 *Practical Air Conditioning*. Rummel and Vogelsang (American 1941).

Covers essential fundamentals and definitions—properties of air, all types of equipment including automatic controls and complete maintenance and servicing methods.

L. A. CARTER,  
*Librarian.*

### Essay Competition, 1945/6 Results

Prizes of £2 2s. 0d. each and Institution Certificates have been awarded to the following five competitors:—

D. Smith, U.S.W., Rugby Radio, "The Ionosphere and the Choice of Frequencies for Long Distance S.W. Radio Communication."

W. Dawson, Y. in T., Edinburgh, "The Metal Plate and Mercury Arc Rectifiers."

J. H. Gardner, S.W.I., Torquay, "The Construction and Action of the Thermionic Valve."

J. A. Hughes, Motor Mechanic, Chester, "Dynamo or Cut-out Trouble."

S. T. Welch, S.W.I., Brighton, "The Transorma." Institution Certificates of Merit have been awarded to:—

W. G. T. Frost, S.W.I., Bristol, "Some Difficulties in Training the Post Office Engineer."

R. E. Beasley, S.W.I., Nottingham, "Rectifiers and their Uses."

M. U. Denny, S.W.I., Repeater Station, Lancaster, "Considerations in the Design of Multi-Channel Line Amplifiers."

A. B. Crowley, S.W.II., Southampton, "Subscriber's Apparatus."

S. M. L. Turner, S.W.II., Leicester, "Underground Construction. Route Laying."

Twenty-seven entries were received.

## Junior Section Notes

### Aberdeen Centre

The Annual General Meeting of the Centre was held on April 26th, Mr. Perryman, Area Engineer, presiding.

The financial report showed that the local funds were very satisfactory, in fact, a proposal was submitted to reduce the membership fees, but in the true Aberdeen spirit it was decided to "ca canny" meantime. The total membership of our centre is now 125.

This Area is rather widespread and in an effort to stimulate the interest of all our colleagues it was decided to elect the committee members for the ensuing session as follows:—

Kirkwall 1, Inverness 2, Peterhead 1 and Aberdeen 4.

The election of office bearers for session 1946-7 was as follows:—

Chairman, W. J. Cowie; Vice-Chairman, D. F. M. Peters; Secretary and Treasurer, S. D. F. Buchan; Librarian, C. L. Bannerman; Committee, N. Johnston, J. Innes, J. L. McLachlan, D. S. C. Buchan, J. Yule, W. B. Davidson, C. P. Milne and A. McKenzie; Auditors, P. L. Dignan and G. Gregson.

The following papers have been promised for session commencing September: "Telephone Service in the Western Isles," "Training," "Clocks," "Teleprinters" and "Coaxial Cable Terminals." It is also expected that during the session film shows will be given.

S. D. F. B.

### London Centre

The commencement of the 1946/7 session of the London Centre was marked by an interesting lecture given by Mr. H. R. Harbottle, O.B.E., B.Sc., D.F.H., M.I.E.E., President of the Junior Section, on "The Wheatstone Bridge and its applications."

A central programme of technical interest is being arranged for the forthcoming winter months, and will begin with a lecture on "The Principles of Coaxial Cable Transmission," by Mr. C. A. Floyd, M.A., A.M.I.E.E.

Further arrangements include lectures by personnel of the "Television Group," Dollis Hill, a B.B.C. engineer, and several visits to public works and factories.

Area Committees are arranging items of local interest, and the chairman of each Committee represents his area on the Centre Committee thus giving close co-ordination of all activities.

Numerous periodicals of engineering and other allied subjects are in circulation, and the distribution is maintained by a Central Librarian.

The interest in the success of the Centre is shown by the fact that the membership is now approaching 700.  
H.E.W.

### Manchester Centre

The Manchester Junior Centre has concluded a most successful post war session for 1945/46, and at the close had 219 members on the roll. We expect to exceed this number next session.

A total of nine visits were made to engineering works and places of interest, ranging from a telephone factory, newspaper offices, radio works, to a local brewery. Our members fully appreciated the visits and responded to the maximum capacity allowed by the various firms.

Three papers were read during the session dealing with V.F. telegraph working, coaxial working, and trunk and junction circuit provision. A very interesting lecture was given by the Area Engineer, Mr. Durkin, on Maintenance.

A film show was held at Telephone House in December 1945 under the auspices of the Ministry of Information and was very well supported. It is intended that the summer months shall not be idle ones in Manchester and we are aiming to form a progressive Social Side. To commence the Social Side we are planning to visit a telephone factory during a working day followed by an afternoon visit to a Buxton Lime Works.

A well-balanced and instructive programme is being prepared for next session and it is our endeavour to increase the interest of the staff in our activities. We ask all our members to sign on the dotted line when the new subscription scheme starts, and whisper words of cheer and encouragement to other members of the staff whose fountain pens run dry when they see an official form.

Let us top the 300 mark this coming session. Your Secretary appreciates the fact that the more work there is for him to do the greater the success of the Centre.

E.G.O.

## Book Reviews

"Electric Wiring Theory and Practice." W. S. Ibbetson, B.Sc., A.M.I.E.E., M.I.Mar.E. 263 pp., 136 ill. E. & F. N. Spon, Ltd. 10s.

This is a revision of the eighth edition published last year, of a well-known book on its subject. The revision is mainly in the first four chapters, which deal with the elementary principles of resistance and inductance and with Ohm's law. These chapters contain a considerable number of worked examples which should be particularly helpful to the elementary student. Successive chapters touch on power distribution and instruments and there follow six chapters on the main subject of the book, wiring work itself. This section begins with accessories (fuses, switches, etc.) and goes on to deal at length and in detail with systems of wiring, types of cable and with practical wiring work; testing and fault finding follow.

A chapter on illumination touches briefly on types of lamp and design in which 80 W fluorescent tubes come in for a very brief reference.

Primary batteries and bells are dealt with in some detail and secondary cells are shortly described; finally there are two good chapters on generating plant and motors.

This book should be of value to engineers who desire to become better acquainted with the details of wiring work and more particularly to learners and apprentices employed on installation work who will appreciate not only the practical information but also the worked examples throughout the book. It has not apparently been possible to include in the revision the latest 1946 supplement to the I.E.E. wiring regulations, which among other amendments has altered the permitted number of points on final sub-circuits and now allows the use of P.V.C. cables. Also the Factories (Standard of Lighting) Regulation lays down a minimum of 6 foot-candles for working positions in certain factories.

H. R. M.

"A Handbook of Telecommunication." B. S. Cohen, O.B.E., M.I.E.E., F.Inst.P. 437 pp., 281 ill. Pitman. 30s.

The late Capt. Cohen spent his few years of retirement from the Post Office Research Station in compiling this handbook. Unfortunately he did not live to see it published and Mr. F. O. C. Baldwin was responsible for the final editing.

Capt. Cohen opens his book with an introductory chapter on acoustics followed by others on microphones, receivers and telephone instruments. These chapters (totalling 52 pp.) contain much useful data not normally included in text-books on telecommunication.

The next section (126 pp.) dealing with manual, automatic and trunk exchange systems contains an excellent series of simplified circuit diagrams and circuit notes, but, in general, the descriptions of apparatus are poor. Most of the circuit descriptions relate to the 2000-selector and sleeve control board, but brief details of other systems, including those not employed by the British Post Office, are included.

The transmission of speech and music is next dealt with (107 pp.). Again skeleton circuit and schematic diagrams are used almost exclusively to explain the principles of feed-back amplifiers, echo-suppressors, companders, modulators, filters, oscillators, etc., followed by outlines of various carrier systems including 4-channel, 12-channel and coaxial underground systems and 3- and 12-circuit open-wire systems.

Nearly half the following chapter (43 pp.) on external plant is devoted to interference from power circuits, corrosion and protection. The remainder covers very

briefly open-line and underground construction methods. Telegraphy is dealt with in an even shorter chapter (34 pp.) which includes modern telegraph systems and machines for landlines and submarine cables, multi-channel V.F. telegraph working, telegraph services, etc.

The last chapter (42 pp.) describes instruments and methods used for the measurement of sound, noise, frequency characteristics, etc., and for the location of faults on cables and apparatus. Finally a series of appendices gives useful data on insulating, conducting and magnetic materials.

The book describes current practice in 1942. The war, which has been largely responsible for the delay in publication, has also retarded many advances in line telecommunication technique so that the work is not seriously out of date, but it will need constant revision in the future if it is to maintain its present high standard. If this can be arranged it may well become the standard reference book on line telecommunication. It should not be inferred from this that it will supplant books like Herbert's "Telephony" and "Telegraphy." These are books each giving a vast amount of detailed information about a limited subject, whereas the book under review covers the whole field but is confined to fundamental principles. It contains, however, copious references to other publications, such as Herbert's works, and this feature adds greatly to its usefulness as a reference work.

H. L.

"Basic Mathematics for Radio Students."

F. M. Colebrook, B.Sc., D.I.C., A.C.G.I. 270 pp., 77 ill. Iliffe & Sons. 10s. 6d.

There are numerous small matters throughout this book that detract from its readability. Firstly, there is the system of referring to paragraph numbers instead of page numbers which makes cross-references needlessly difficult to find. Paragraph headings are indented into the side of paragraphs some four lines from the commencement, so that one has commenced a new paragraph before coming to the heading. The type employed for the numerals is confusing, e.g. 1 is used for figure one in main expressions, but 1 as an index or subscript. Different fonts are mixed in some expressions and other type-setting errors have been missed in a number of instances. Generally the type-setting of expressions involving indices is poor. These are unfortunate and needless irritations which the author and publisher would do well to eliminate in future issues.

As regards the more important criticism of "fitness for purpose," it seems doubtful whether the book is suitable for use in schools and colleges, as in the space of a mere 270 pp., each only 5½ in. by 3½ in., the author covers an enormous field. In the opening pages the reader is assumed not to know anything of algebra, but by page 96 he is being introduced to complex algebra and by page 186 is learning the differential calculus, having covered series, geometry, trigonometry, etc., *en passant*. The pace is too hot for all but the most exceptional student!

This is very unfortunate as the book has many attractive features. The style is easy, being a happy compromise between the stiff formality of the conventional text-book and the popular type written for the layman. The order and methods of presentation of the various subjects are, in general, excellent. For instance, it is refreshing to find geometry presented in terms of vectors, leading naturally to trigonometrical ratios and so to hyperbolic functions. One cannot but wish that the author had found it possible to write a series of such text-books covering the ground in a more leisurely manner.

H. L.



# Staff Changes

## Promotions

Name	Region	Date	Name	Region	Date
<i>Exec. Engr. to A.S.E.</i>			<i>Chief Insp. to Asst. Engr.—continued</i>		
Calveley, C. E.	E.-in-C.O.	9.7.46	Pyman, F. A. M.	L.T.R.	27.7.46
<i>Asst. Engr. to Exec. Engr.</i>			Batch, G. B.	H.C. Reg.	27.7.46
Lyddall, A. G.	S.W. Reg. to N.E. Reg.	14.5.46	New, S. E.	W. & B.C. Reg.	27.7.46
Mayne, E. A.	H.C. Reg. to Mid. Reg.	11.6.46	Spratley, E. W. F.	E.-in-C.O.	27.7.46
Hoare, E.	H.C. Reg. to N.E. Reg.	19.5.46	Sims, A. E. J.	E.-in-C.O. to L.T.R.	1.9.46
Robins, A. G.	H.C. Reg.	14.5.46	Humphreys, L. W.	E.-in-C.O. to L.T.R.	18.8.46
Edwards, S. J.	S.W. Reg.	25.8.46	Rivis, J. W.	E.-in-C.O. to S.W. Reg.	1.9.46
Mayo, S. J.	W. & B.C. Reg.	14.5.46	<i>Insp. to Chief Insp.</i>		
Probert, G. A.	Mid. Reg.	14.5.46	Barnes, F. L.	L.T.R.	21.2.46
Tillman, J. R., Ph.D.	E.-in-C.O.	14.5.46	Pilcher, C. F. J.	L.T.R.	5.3.46
Clarke, A. C. W. V.	L.P. Reg.	1.9.46	Turner, H. E.	L.T.R.	9.5.46
Lawton, J.	E.-in-C.O.	16.7.46	Johnson, H. N.*	Test Section, B'ham	19.5.46
Armstrong, R. G., M.C.	E.-in-C.O. to N.W.R.	11.6.46	Dawson, C. F. O.	L.T.R.	17.3.46
Mascall, T. H. A.	L.P. Reg.	1.7.46	Painter, C. H.	Mid. Reg.	24.3.46
De Jong, N. C. C.	S.W. Reg. to W. & B.C. Reg.	1.5.46	Haythornthwaite, F.	E.-in-C.O.	25.4.46
de Courcy, F. J.	N. Ire. R. to Scot. Reg.	27.5.46	Lockwood, C. R.	H.C. Reg.	17.7.46
Bawtree, K. O.	L.P. Reg. to N.E. Reg.	16.7.46	Lewis, F. S.	Test Section, B'ham	19.5.46
Stevenson, H. C.	Scot. Reg.	14.5.46	Jarvis, H. W.	H.C. Reg.	14.7.46
Chorley, J. W. A.	E.-in-C.O.	30.7.46	Thomas, A. S.	S.W. Reg.	10.6.46
<i>Chief Insp. to Asst. Engr.</i>			Pearson, F. C.*	Test Section, Lndon	4.2.46
Miller, R. W.	E.-in-C.O. to W. & B.C. Reg.	24.6.46	Hudson, G. J.	Test Section, London	4.2.46
Apperley, H. L.	S.W. Reg.	10.6.46	English, H. J.	L.T.R.	17.3.46
Hatfield, W. H.	E.-in-C.O.	27.7.46	Gale, C. M. S.	L.T.R.	10.3.46
			Garnett, J. A.	L.T.R.	16.3.46
			Wells, L. A.	L.T.R.	9.4.45
			Kerner, S.	L.T.R.	15.5.46
			Ogle, T.	N. Ire. Reg.	15.5.46

\* In absentia.

## Retirements

Name	Region	Date	Name	Region	Date
<i>Chief Reg. Engr.</i>			<i>Insp.</i>		
Scutt, W. D.	N.E. Reg.	30.6.46	Green, F. R.	H.C. Reg.	31.12.45
<i>Exec. Engr.</i>			Le Cluse, E. A.	H.C. Reg.	31.12.45
Akester, A.	E.-in-C.O.	24.6.46	Bishop, H. J.	H.C. Reg.	31.1.46
Bartlett, A. W.	L.P. Reg.	30.6.46	Hoad, S. E.	H.C. Reg.	19.2.46
<i>Asst. Engr.</i>			Hawkes, D. J.	L.T.R.	17.3.46
Sursham, J. W.	H.C. Reg.	30.6.46	Seach, G. E.	H.C. Reg.	18.3.46
Ellis, F.	L.T.R.	17.7.46	Davidson, S. J.	N.W. Reg.	31.3.46
<i>Chief Insp.</i>			Hargreaves, F. C. B.	N.E. Reg.	31.3.46
Roe, W. D. A.	L.P. Reg.	30.6.46	Megson, F. W.	N.W. Reg.	31.3.46
Webster, C. J.	H.C. Reg.	16.7.46	Walker, A. G.	H.C. Reg.	31.3.46
			Martin, W. G. B.	W. & B.C. Reg.	1.4.46
			Milton, G. F. A.	S.W. Reg.	17.5.46
			Leach, R. W.	L.T.R.	24.5.46
			Cooper, J. W.	W. & B.C. Reg.	15.6.46
			Goulbourn, R.	N.W. Reg.	17.6.46
			McCawley, A.	L.T.R.	30.6.46
			Heath, C. A. F.	L.T.R.	12.7.46
			Steward, S. G.	L.T.R.	2.8.46
			Pask, W. J.	L.T.R.	26.8.46

## Resignations

Name	Region	Date	Name	Region	Date
<i>Asst. Engr.</i>			<i>Insp.—continued</i>		
Greenman, L. H.	N.W. Reg.	25.9.45	Hoare, S. R.	L.T.R.	30.6.46
<i>Insp.</i>			<i>Asst. Chemist</i>		
Mackereth, W. W.	N.W. Reg.	30.1.46	Dickie, H. F.	Test Section, London	5.7.46
Curtis, G. D.	H.C. Reg.	11.5.46			

### Deaths

Name	Region	Date	Name	Region	Date
<u>Asst. Engr.</u>			<u>Insptr.</u>		
Gillman, C. E.	L.T.R.	7.7.46	Duckworth, F.	N.W. Reg.	25.6.46
			Stevenson, P.	N.W. Reg.	8.7.46

### Transfers

Name	Region	Date	Name	Region	Date
<u>Exec. Engr.</u>			<u>Insptr.</u>		
Stanbury, H. C. O.	Scot. Reg. to Mid Reg.	13.5.46	Gates, N. P.	N. Ire. Reg. to H.C. Reg.	14.1.46
England, A. G.	Mid. Reg. to Scot. Reg.	20.5.46	Hudson-Davies, J.	E.-in-C.O. to Sudan Govt.	15.3.46
Griffiths, G. J.	On loan to Admiralty (reverts to Asst. Engr., Mid. Reg.)	20.5.46	Keeble, T. A.	H.C. Reg. to S.W. Reg.	1.5.46
Gill, F. W.	E.-in-C.O. to L.T.R.	21.5.46	Gange, H. G.	E.-in-C.O. to N.W. Reg.	24.6.46
			Faulkner, E. B.	N.W. Reg. to E.-in-C.O.	15.7.46
			Rogers, M. J.	W. & B.C. Reg. to E.-in-C.O.	22.7.46
			Sard, G. J.	H.C. Reg. to E.-in-C.O.	1.8.46
			Sanders, R. V.	Scot. Reg. to E.-in-C.O.	6.8.46
<u>Asst. Engr.</u>			Bailey, E. E.	Scot. Reg. to L.T. Reg.	10.8.46
Draper, J. H. P.	L.T.R. (Mobilised) to E.-in-C.O.	1.6.46	Ingram, C. S.	Leafield R/S to E.-in-C.O.	11.8.46
Clarke, A. C. W. V.	E.-in-C.O. to L.P. Reg.	16.7.46	Higson, W.	E.-in-C.O. to Mid. Reg.	26.8.46
			Holmes, A. C.	E.-in-C.O. to N.E. Reg.	6.9.46

### BOARD OF EDITORS

A. J. GILL, B.Sc., M.I.E.E., F.I.R.E., Chairman.  
 F. E. NANCARROW, O.B.E., A.R.C.Sc., M.I.E.E.  
 P. B. FROST, B.Sc., M.I.E.E.  
 A. H. MUMFORD, O.B.E., B.Sc.(ENG.), M.I.E.E.  
 C. W. BROWN, A.M.I.E.E.  
 C. E. SKUSE.  
 H. LEIGH, B.Sc.(ENG.), M.I.E.E., Managing Editor.  
 G. E. STYLES, A.M.I.E.E. } Assistant  
 J. P. HARDING, B.Sc.(Eng.) } Editors.  
 A.M.I.E.E.,  
 A. J. BAKER, Secretary-Treasurer.

### Copyright

The entire contents of this JOURNAL are covered by general copyright, and special permission is necessary for reprinting long extracts, but Editors are welcome to use not more than one-third of any article, provided credit is given at the beginning or end thus: "From the *Post Office Electrical Engineers' Journal*."

The Board of Editors is not responsible for the statements made or the opinions expressed in any of the articles in this JOURNAL, unless such statement is made specifically by the Board.

### Communications

All Communications should be addressed to the Managing Editor, *P.O.E.E. Journal*, Engineer-in-Chief's Office, Alder House, Aldersgate Street, London, E.C.1. Telephone: HEADquarters 1234. Remittances should be made payable to "The *P.O.E.E. Journal*" and should be crossed "& Co."

### Binding Cases

Cases for binding are available, and may be obtained from the Local Agents for 2s. Subscribers can have their copies of Volumes bound, at a cost of 7s. 6d., by sending the complete set of parts to the Local Agents or to the *P.O.E.E. Journal*, Engineer-in-Chief's Office, Alder House, Aldersgate Street, London, E.C.1. Orders for binding for Vols. 1-19 should indicate whether the original binding case with black lettering, or the later pattern with gold, is required. Cases with gold lettering are the only type stocked from Vol. 20 onwards.

### Back Numbers

The price of the JOURNAL, which is published quarterly, is 1s. (1s. 3d. post free) per copy, or 5s. per annum post free. Back numbers can be supplied, subject to availability of stocks, at 1s. each (1s. 3d. post free). Orders for back numbers may be sent to the Local Agents or to the Publishers.

### Advertisements

All communications relating to space reservations should be addressed to the Advertisement Editor, *P.O.E.E. Journal*, Alder House, Aldersgate Street, London, E.C.1. Communications regarding advertisement copy, proofs, etc., should be addressed to the Publishers, Messrs. Birch & Whittington (Prop. Dorling & Co. [Epsom], Ltd.), 49 Upper High Street, Epsom, Surrey.

50-range Model 7  
Universal Avometer

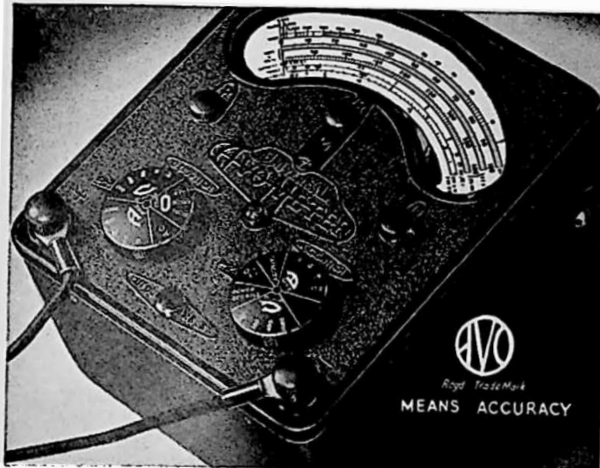

**'AVO'**

*Meters that Matter*

THE world-wide use of "AVO" Instruments is striking testimony to their outstanding versatility, precision and reliability. In every sphere of electrical test work, they are appreciated for their dependable accuracy, which is often used as a standard by which other instruments are judged.

Sole Proprietors and Manufacturers  
THE AUTOMATIC COIL WINDER & ELECTRICAL EQUIPMENT Co. Ltd.  
Winder House, Douglas Street, London, S.W.1  
Phone: VICTORIA 3404-B

The COMPLETE, up-to-date guide to Telephony and Telegraphy—

## A HANDBOOK OF

## TELECOMMUNICATION

By Bertram S. Cohen, O.B.E.,  
M.I.E.E., F.Inst.P. Edited by  
F. G. C. Baldwin, O.B.E., M.I.E.E.

This new book by a well-known international authority, and a former Director of the Post Office Research Station, is of supreme importance to Post Office engineers concerned with telephone and telegraph work, and to all students of these subjects. It includes particulars of the latest technical developments, many of them based on quite recent discoveries in physics. **30/- net**

The standard textbook on  
MANUAL systems of telephony

**TELEPHONY Vol. I:**  
Manual Switching System and  
Line Plant

By T. E. Herbert, M.I.E.E., former Superintending Engineer to the G.P.O., and  
W. S. Procter, A.M.I.E.E., Regional Engineer, Post Office Engineering Department.

An exhaustive guide to the systems of manual telephony in current use, and for many years the standard authority. Second Edition, 1,200 pages, 25/- net.

Now Reprinting: **TELEPHONY Vol. II:**  
**AUTOMATIC TELEPHONY**

**PITMAN**

★  
Parker Street,  
Kingsway, London, W.C.2

*Clip-on*

iv

# FOR EASY CURRENT MEASUREMENTS

in Busbars, Fuses and Cables up to 2 1/8" diam.

- DUAL RANGE WITH SELECTOR SWITCH
- FULLY INSULATED CORE AND HANDLE

# FERRANTI

DUAL RANGE

## *Clip-on* AMMETER

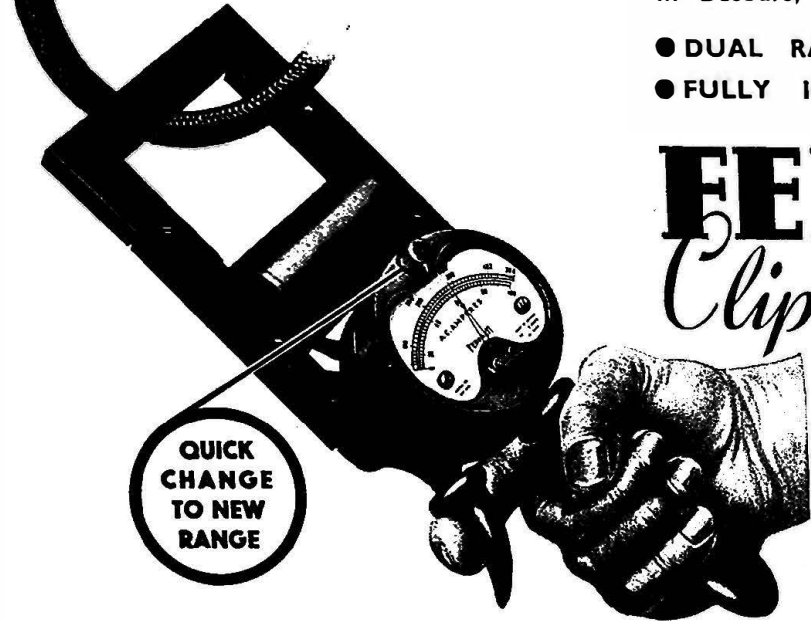

QUICK  
CHANGE  
TO NEW  
RANGE

### RANGES

- 0—10—50 Amps.
- 0—20—100 Amps.
- 0—50—250 Amps.
- 0—100—500 Amps.
- 0—200—1000 Amps.

PL 554

FERRANTI LIMITED, Hollinwood, Lancs.

London Office : Kern House, Kingsway, W.C.2

**ELECTRICAL MEASURING  
INSTRUMENTS  
OF THE HIGHER GRADES**



**ERNEST TURNER ELECTRICAL INSTRUMENTS LTD.**  
CHILTERN WORKS, TOTTERIDGE AVENUE, HIGH WYCOMBE, BUCKS.

Telephone : High Wycombe 1301/2

Telegrams : Gorgeous, High Wycombe

## INDEX TO ADVERTISERS

Alton Battery Co., Ltd., The .. .. .	xv
Automatic Coil Winder & Electrical Equipment Co., Ltd.	iii
Automatic Telephone & Electric Co., Ltd. .. .. .	x, xi
Bennett College, The .. .. .	xvi
Creed & Co., Ltd. .. .. .	xiii
Edison Swan Electric Co., Ltd., The .. .. .	ii
Elliott Bros. (London), Ltd. .. .. .	xix
Ernesson Telephones, Ltd. .. .. .	viii
Ferranti, Ltd. .. .. .	iv
General Electric Co., Ltd., The .. .. .	xviii
Great Northern Telegraph Co., Ltd., The .. .. .	ix
H. T. A., Ltd. .. .. .	ix
Multicore Solders, Ltd. .. .. .	xx
Neosid, Ltd. .. .. .	xiii
Parmeko, Ltd. .. .. .	vi
Pirelli General Cable Works, Ltd. .. .. .	xx
Pitman, Sir Isaac and Sons, Ltd. .. .. .	iii
Salford Electrical Instruments Ltd. .. .. .	ii
Siemens Brothers & Co., Ltd. .. .. .	vii
Smith, Frederick, & Co. .. .. .	v
Standard Telephones and Cables, Ltd. .. .. .	xiv
Sullivan, H. W., Ltd. .. .. .	xix
Telephone Manufacturing Company, Ltd. .. .. .	xvi
Tudor Accumulator Co., Ltd., The .. .. .	xii
Turner, Ernest, Electrical Instruments Ltd. .. .. .	iv
United Insulator Co., Ltd. .. .. .	v
Westinghouse Brake & Signal Co., Ltd. .. .. .	vi
Winn & Coales, Ltd. .. .. .	xvi

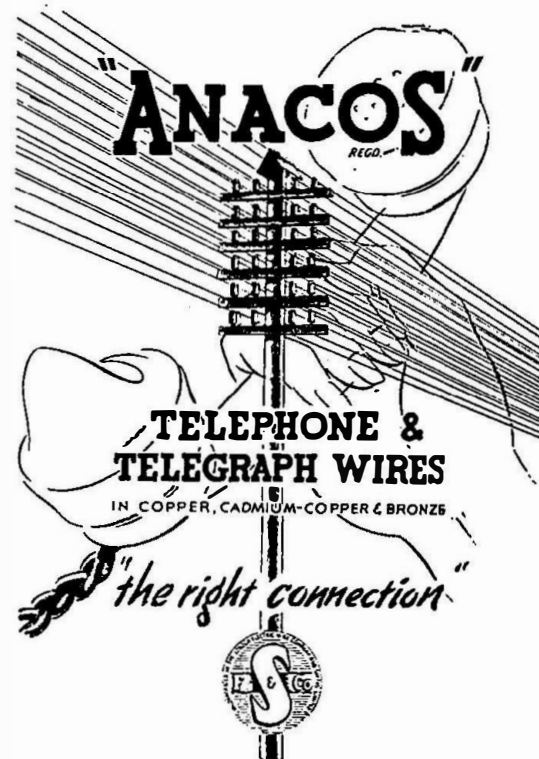

**FREDERICK SMITH & COMPANY**  
 (Incorporated in The London Electric Wire Company and Smiths, Limited)  
**ANACONDA WORKS, SALFORD 3, LANCs.**  
 Phone : Blackfriars 8701 (9 lines) • Grams : "Anaconda," Manchester



# U.I.C.

*Silvered Mica & Ceramic*  
**CAPACITORS**

A wide range of types for  
 all purposes

**UNITED INSULATOR CO. LTD.**  
 Oakcroft Rd., Tolworth, Surbiton, Surrey  
 Phone : Elmbridge 5241 Grams : Calanel, Surbiton

*Unsurpassed In Ceramics*

# METAL RECTIFIERS

for use in Repeater Stations

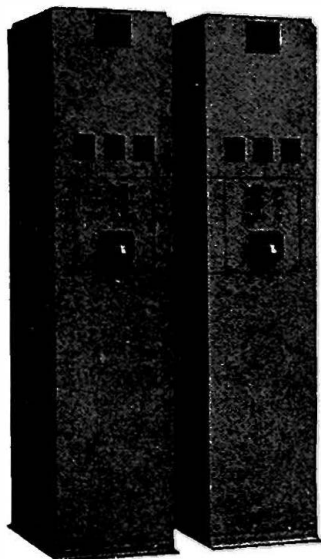

Designed on the Moving-coil Voltage Regulator principle to "float" small H.T. and L.T. batteries in Repeater Stations, a large capacity "stand-by" battery being brought into service in the event of a mains failure.

Housed in the same cubicle as the "float" rectifier is a rectifier and transformer for recharging the stand-by battery, this circuit also acting as a stand-by to the "float" rectifier.

Also included is a trickle-charge rectifier to maintain the "stand-by" battery in good condition.

The typical equipment illustrated consists of (a) rectifier and transformer for floating the L.T. battery, rectifier and transformer for recharging the "stand-by" L.T. battery, and rectifier and transformer for trickle-charging the stand-by battery; and (b) identical equipment for use with the H.T. battery.



*the versatile rectifier  
of outstanding reliability*

**WESTINGHOUSE BRAKE & SIGNAL CO., LTD.**  
82 York Way, King's Cross, London, N.1



FOR POLISHING THE SPURS ON THE HIGH  
HEELED BOOTS OF A COWBOY NAMED  
D'ARCY FROM WYOMING . . .

We have never received quite such a foolish enquiry and we use it only to attract your amused attention and to show you that we make Transformers for almost every purpose. So no matter how simple your requirements - no matter how small or large - do let us have a look at the problem next time. Illustrated is a special Transformer for Aeronautical Research designed for operation at three cycles per second.

PARMEKO LTD  
OF LEICESTER.

MAKERS OF  
TRANSFORMERS.

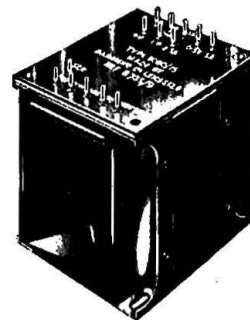

# SIEMENS

## TELECOMMUNICATION EQUIPMENT

AUTOMATIC TELEPHONE EXCHANGES  
including the following types

Trunk	T.A.X.
Main	M.A.X.
Rural	R.A.X.
Unit	U.A.X.
Private	P.A.X.
Private Branch	P.A.B.X.

MANUAL EXCHANGES  
of all types

CARRIER TRANSMISSION EQUIPMENT

TELEPHONE INSTRUMENTS  
of all types

TELEPHONE SWITCHING EQUIPMENT

PROTECTIVE DEVICES

RELAYS

TELEPHONE CABLES, WIRES & CORDS

LOADING COILS

MARINE RADIO EQUIPMENT

SHIPS' TELEGRAPHS & TELEPHONES

CELLS & BATTERIES  
Dry, Fluid and Inert



*Designed for service  
in all parts of the world*

BY close attention to technical detail the Company has maintained its position in the forefront of Telecommunication Engineers throughout its long experience. Its products enjoy a world-wide reputation for sound design and technical excellence.

The Company undertakes the supply and installation of complete Automatic and Manual Telephone Exchanges for Public and Private service, Automatic and Manual Trunk Exchanges, all types of Telephone Cables for Trunk and Local Service, Carrier Transmission Equipment and Cables, Radio Equipments for Ships.

**SIEMENS BROTHERS**  
& CO., LIMITED  
WOOLWICH  
LONDON, S.E.18

*Achievement...*  
*by*  
**Ericsson**



ERICSSON TELEPHONES, LTD., Head Office : 56 Kingsway, London, W.C.2. Phone: HOLborn 6936



**UNIVERSALLY ADOPTED**

**G.N.T.Co. TRANSMITTER  
MODEL 112**

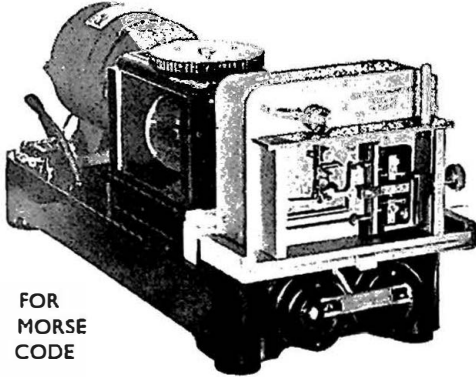

FOR  
MORSE  
CODE

13-250 words per minute without gear changes  
or readjustments.

Absolutely constant speed at all settings not-  
withstanding large voltage variations.

Noted for its easy maintenance.

Supplied with A.C. or D.C. motors as required.

**THE GREAT NORTHERN TELEGRAPH CO. LTD.**  
OF DENMARK

KONGENS NYTORV 28  
COPENHAGEN K. - DENMARK

AND

5, ST. HELEN'S PLACE,  
LONDON, E.C.3

**H.T.A. LIMITED**

*Formerly Hall Telephone Accessories (1928) Limited.*

Contractors to H.M. Post Office, Admiralty, M.O.S., and  
Dominion and Foreign Administrations.

*Precision Engineers and Instrument Makers*

**Manufacturers of Prepayment Telephone Multi-Coin Collectors, Gas  
Leak Indicators, Automatic Stamp Selling and Ticket Selling Machines,  
Automatic Slot Machines and Fire Alarm Apparatus.**

*Enquiries Invited.*

*Registered Office and Works:—*

**DUDDEN HILL LANE, WILLESDEN, LONDON, N.W.10**

Telephone: WILLESDEN 5141, etc.

# LINK THE WORLD'S

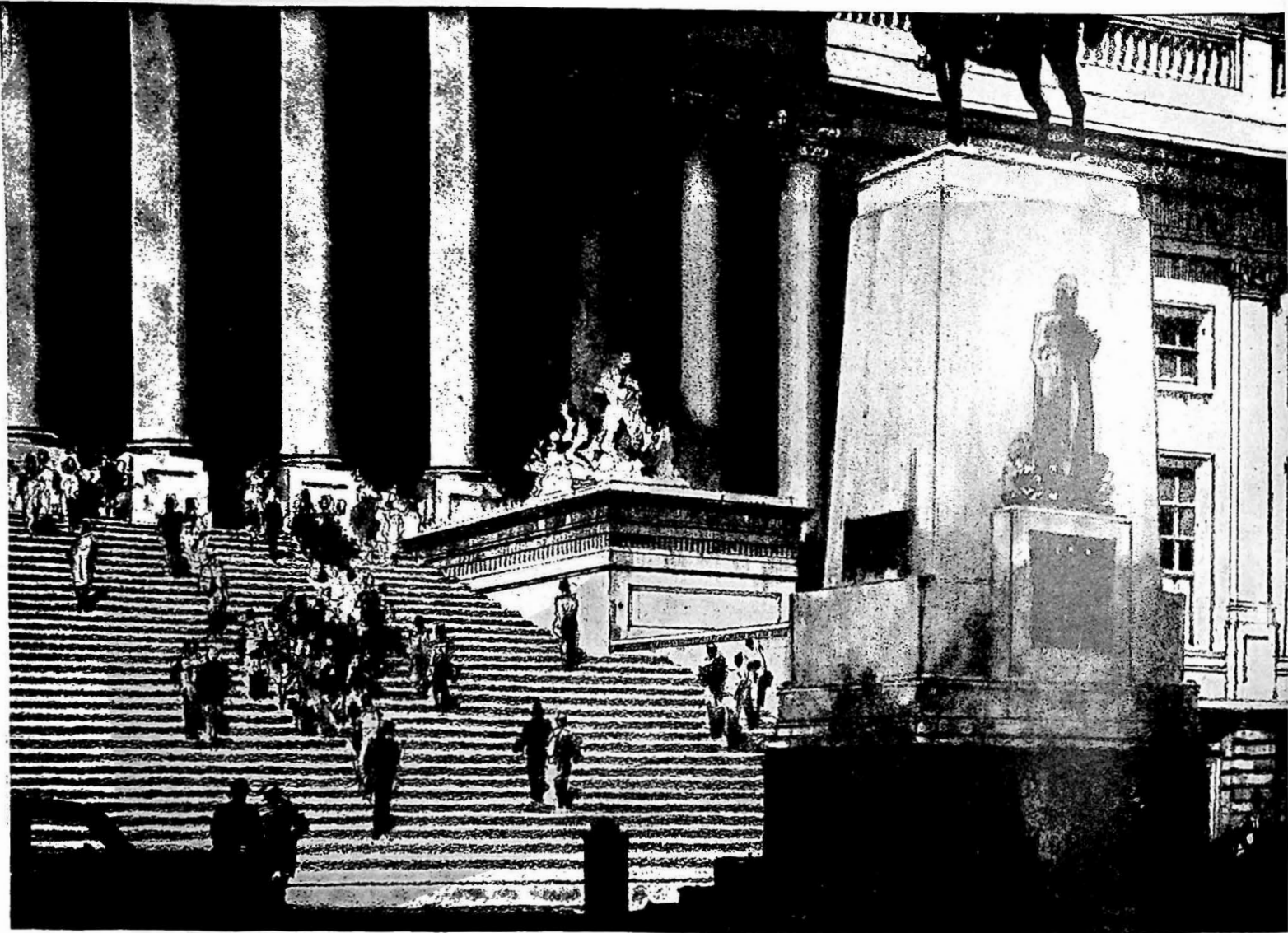

## **STROWGER PRIVATE AUTOMATIC EXCHANGES**

- Utilise equipment which is similar in design and construction to that in Strowger Exchanges for public service.
- Provide service for any number of lines from five up to several hundreds.
- Are entirely self-contained and totally enclosed.
- Operate from either alternating or direct current supply mains.
- Provide a number of Special Services where required, such as:—
  - Key-Calling Service, giving priority to executives when making calls.
  - Conference service, enabling telephone conferences to be held.
  - Secretarial Service, enabling all calls to a principal to be initially handled through a secretary.
  - Code Call Service for staff "paging" and location purposes.
  - Alarm Service for fire or other emergency calls.

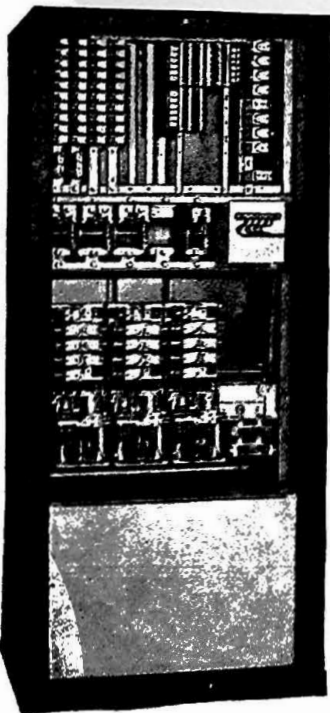

# RESOURCES . . .

---

---

## *In the seats of Government*

Re-adjustment of the affairs of the world is a pressing problem, requiring unity of action on the part of many nations each with a viewpoint and a set of practical circumstances entirely its own. To reach agreement on such points the utmost freedom in the interchange of ideas and opinions is necessary. This must be possible firstly on a local, then on a national and finally on an international basis. Communications have a vitally important part to play and telephone service in particular has a function which could not be fulfilled by any other means. Strowger Automatic Telephone Equipment has a special application to the need. Its speed of operation is invaluable when controversial matters are to be referred from one point to another or when quick decisions are to be made, whilst its ability to function without human operators ensures complete secrecy. Strowger Private Automatic Exchanges are available for internal communication in secretariats, administrative offices and the like, whilst Main Automatic Exchanges handle the needs of local areas or effect contact over long distances with equal effectiveness.

*with . . .*

**STROWGER**  
**TELECOMMUNICATIONS**



**AUTOMATIC TELEPHONE & ELECTRIC CO. LTD.**

EXPORT DEPARTMENT:

NORFOLK HOUSE, NORFOLK STREET, LONDON, W.C.2, ENGLAND  
STROWGER WORKS, LIVERPOOL 7, ENGLAND

ATM 2000

## IMPORTANT ANNOUNCEMENT

# THE POST OFFICE ELECTRICAL ENGINEERS' JOURNAL

- From January, 1947, increases in the paper ration will permit the **Journal** to be just double its war-time size, and thus allow a greater range of subjects to be covered in each issue. In addition the Supplement will be increased in size so that answers to all the questions set in City and Guilds examinations in Telecommunications subjects will be included as was done pre-war. The increase in paper ration will also permit new subscribers to be accepted.

The **Journal** is still sold at the pre-war price of 1/- per copy (1/3 post free), though the increase in size may necessitate an increase in price shortly. It is published quarterly in January, April, July and October. *Subscriptions should be sent to:—*

**The Managing Editor,  
G.P.O. (Alder House),  
London, E.C.1**

or to any of the Journal local agents.

*For large scale  
Electrical  
Purposes*



It is noteworthy where Tudor accumulators are to be found fulfilling the most important duties: over 500 British Power Stations installed Tudor. Many Tudor installations rank among the largest in the land and have an enviable reputation for long-lived reliability. No matter whether they were installed only yesterday, or over thirty

years ago—as many of them were—they are to-day functioning with consistent efficiency.

*SAFETYLYTE is the Tudor Emergency Lighting System, which is automatic and instantaneous in operation. It is installed in thousands of schools, hospitals factories and other large buildings.*



**TUDOR ACCUMULATORS**

THE TUDOR ACCUMULATOR CO. LTD  
50 GROSVENOR GARDENS, LONDON, S.W.1

**TELEPRINTER TAPE****MODEL 47****FOR - RECORD COMMUNICATION -**

- Printing point is in ideal position on left side.
- Last character printed is immediately visible.
- Receiving cam orientation device for optimum adjustment for acceptance of distorted signals.
- Conforms to C.C.I.T. recommendations.

**A NEW PRODUCT****Creed**

- Tape may be replenished without removing cover.
- Accessible printing unit using typewriter ink ribbon.
- Answer-back unit (20 characters).
- Special provision for message forms to facilitate handling of heavy traffic.
- Simplified maintenance with unit construction.

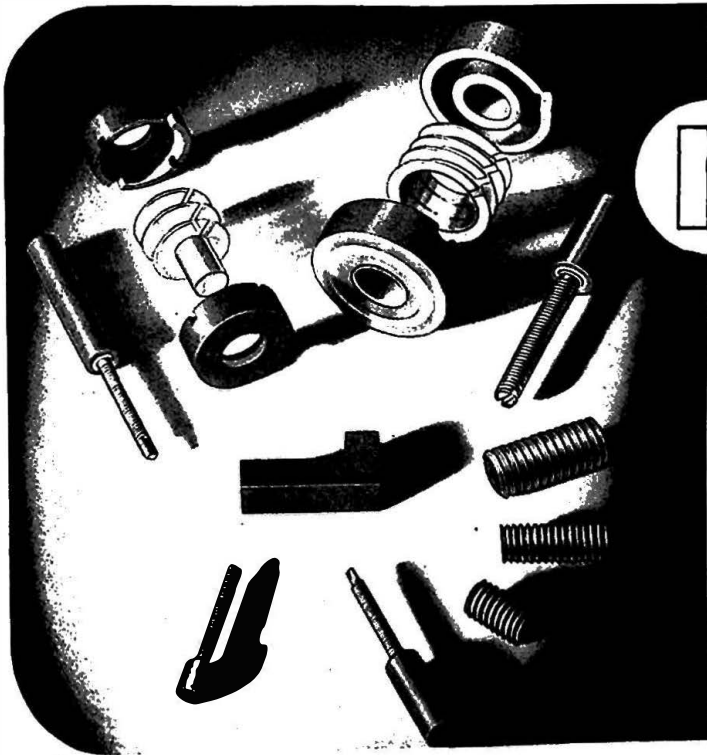
***Creed and Company Limited*****TELEGRAPH HOUSE, CROYDON, ENGLAND**TELEGRAMS : "CREDO, TELEX, CROYDON"  
TELEPHONE : CROYDON 2121 (6 LINES)● CABLES : "CREDO, CROYDON"  
● TELEX CROYDON TELEX 1082**neosid****IRON  
DUST  
CORES**High performance : Strength : Stability  
Close electrical and mechanical tolerances  
Grades to suit various applications**neosid** *limited***23 and 25 Hyde Way, Welwyn  
Garden City, Herts.**

Tel : Welwyn Garden 925

# permalloy permendur

**S**TANDARD MAGNETIC MATERIALS have the unique advantage of being produced by a Company which itself is a large scale user of these materials, as a result of which a vast amount of direct experience in the use of magnetic alloys has become available. Permalloy Nickel/Iron Alloys are particularly suitable in cases which demand high permeability and low losses—especially low hysteresis loss; they should, however, be selected according to individual requirements. V-Permendur, one of the Cobalt/Iron alloys, should be employed where high permeability throughout a wide range of flux densities is called for, and it finds special application in diaphragms for high quality telephone receivers.

**PERMALLOY C.** Gives the highest initial permeability of any magnetic material yet known. Applications: wide frequency-band transformers; accurate current transformers, chokes, sensitive relays and magnetic shielding.

**PERMALLOY B.** Lower initial permeability than "C," but higher flux densities possible.

**PERMALLOY D.** High resistivity without undue lowering of flux density or of the Curie Point. Very suitable for certain high frequency applications since frequency/permeability variation is small.

**V-PERMENDUR.** A Cobalt/Iron alloy with unusually high flux density. It can be rolled to .010 in. strip and exhibits high permeability up to high flux densities.



## MAGNETIC MATERIALS

	Permalloy "B"	Permalloy "C"	Permalloy "D"	V- Permendur
Specific gravity ...	8.3	8.6	8.15	8.2
Electrical resistivity, microhms per cm. cube ...	55	60	90	26
Temperature for heat treatment °C...	900	1,050	900	790
Initial permeability $\mu_s$	1,800 to 2,400	10,000 to 30,000	1,500 to 2,000	700 to 1,000
Maximum permeability $\mu_{max}$	10,000 to 20,000	50,000 to 100,000	6,000 to 8,000	3,000 to 5,000
Magnetising force for $\mu_{max}$ oersteds ...	0.30 to 0.60	0.025 to 0.04	0.5 to 1.0	2.0 to 6.0
Maximum flux density, gauss ...	16,000	8,000	13,000	23,000
Coercive force in oer- stedts for $B_{max} =$ 5,000 gauss ...	0.25	0.03	0.5	—
Remanance in gauss for $B_{max} = 5,000$ gauss	4,000	3,500	3,500	—
Hysteresis loss in ergs per c.c. per cycle for $B_{max} = 5,000$ gauss	300	45	550	—
Total loss in watts/ lb. $B = 5,000$ gauss, 50 c/s 0.015 in. sheet	0.11	0.04	0.2	—

*Standard Telephones and Cables Limited*  
ENGINEERS • NORTH WOOLWICH • TELECOMMUNICATION  
LONDON • E.16

## MORE POWER TO LOCHABER!



*Despising all other weapons, the clansman trusted to his claymore and superb swordsmanship*

**T**HE old-time history of Lochaber is that of highland clans, highland feuds and the 'forty-five'. But today the power of this wild and picturesque district no longer lies in the claymore; it comes instead from one of the greatest industrial developments of recent times which, promoted at a cost of millions of pounds, harnesses the waters of the countryside to generators that give an immense output of electrical power. A new page to highland history indeed! . . . and one in which it is recorded that an Alton battery has been installed in the hydro-electric station for emergency and other important duties.

# ALTON

## BATTERIES OF MERIT

THE ALTON BATTERY COMPANY LTD., ALTON, HANTS

Sole Suppliers of Fuller Stationary Batteries

Telephone : Alton 2267 and 2268    Telegrams : ' Battery, Alton '



# DENSO *for Sealing* PLAST *Cable Entries*



DENSO PLAST is one of a wide range of 'DENSO' products for permanent protection against chemical and electrolytical corrosion. Permanently plastic, it can be pressed into any shape to form a completely protective seal—withstanding traffic vibration and building settlement.



Despite the adverse conditions under which these ducts were caulked in 1936, Denso Plast is still holding out the water with complete success.

**Denso**  
PERMANENTLY PLASTIC PROTECTION

Write for Specification and price list  
**WINN & COALES LTD**  
TERMINAL HOUSE, GROSVENOR GARDENS, LONDON, S.W.1  
Telephone and Telegrams: Sloane 6264

STUDY  
AT  
HOME

You Can Have a College Training  
For a Few Shillings Monthly

IN YOUR  
SPARE  
TIME

FOUNDED 1900

40 YEARS OF SUCCESS

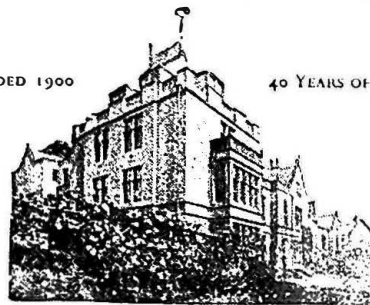

CITY and GUILDS (Telecommunication) EXAMINATIONS

To every student we send a written Guarantee of Tuition until the examination is actually passed

Our tuition is so graded that each stage is reached without difficulty.

Personal attention is given to every student.

FULL PARTICULARS AND ADVICE SUPPLIED FREE. WE TEACH BY POST IN ALL PARTS OF THE WORLD.

*The most progressive and most successful  
Correspondence College in the world*



Dept. 24, THE BENNETT COLLEGE, SHEFFIELD

## CARPENTER

# *Polarised High Speed* RELAY

### ● MAIN FEATURES OF STANDARD MODEL

High Speed. Short transit time. Negligible distortion up to 300 c/s.

Contact gap a function of input power, hence small distortion almost down to failure point. High contact pressures. No contact chatter.

High sensitivity—robust operation at 5 mV.A. at 100 c/s or 0.2 mW.D.C.

Great ease of adjustment. Magnetic bias adjustment giving absolutely smooth control.

Balanced armature—hence immunity to considerable vibration and no positional error.

DIMENSIONS IN COVER: 2½x1½x4½. WEIGHT with standard socket: 22 ozs.

Complete details and test data available on request.

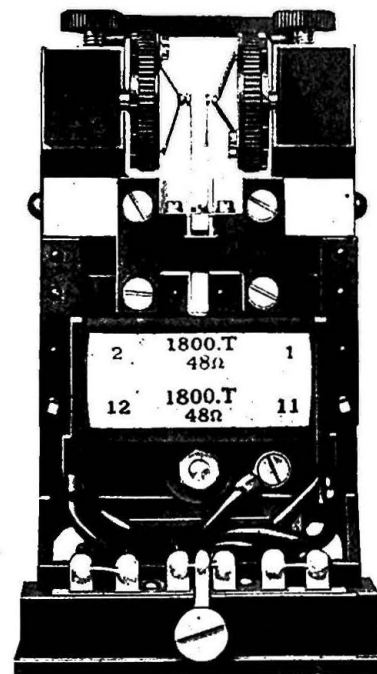

**TELEPHONE MANUFACTURING CO., LTD.**  
HOLLINGSWORTH WORKS · DULWICH · LONDON · S.E.21

Telephone: GIPsy Hill 2211 (10 lines)



# THE INSTITUTION OF POST OFFICE ELECTRICAL ENGINEERS

---

## PRINTED PAPERS

---

The following papers contributed to the proceedings of the Institution have been printed by authority of the Council and may be obtained, if still in print, from

**“ THE LIBRARIAN,  
The Institution of Post Office Electrical Engineers,  
G.P.O. (ALDER HOUSE), LONDON, E.C.1 ”**

The prices do *not* include postage, and in every case, Members, Associate Members, and Associates have the privilege of purchasing copies at two-thirds the stated price. Papers not included in the list are already out of print.

- |   |  |
|---|--|
| <p>*No. 116. "THE DIRECTOR IN AUTOMATIC TELEPHONY."—<br/>C. W. BROWN, A.M.I.E.E. 1927 9d.</p> <p>*No. 154. "THE TELEGRAPH POLE."—W. H. BRENT, B.Sc., A.M.I.E.E. 1933 1s.</p> <p>*No. 163. "AUTOMATIC EXCHANGE DESIGN."—<br/>H. E. FRANCIS. 1936 1/3</p> <p>*No. 165. "PROPERTIES AND TESTING OF DIELECTRIC MATERIALS."—J. F. DOUST and W. J. SULSTON, M.Sc., A.Inst.P. 1936 1s.</p> <p>*No. 166. "CHEMISTRY AND COMMUNICATIONS."—D. W. GLOVER, M.Sc., A.I.C. 1937 6d.</p> <p>*No. 167. "TWELVE-CIRCUIT CARRIER TELEPHONE SYSTEMS."—G. J. S. LITTLE, B.Sc., A.M.I.E.E. 1938 6d.</p> <p>*No. 168. "THE DEVELOPMENT OF MAGNETIC MATERIALS."—C. E. MORGAN, A.M.I.E.E. 1938 6d.</p> <p>*No. 169. "CROSSTALK."—H. C. S. HAYES, A.M.I.E.E., R. A. SEYMOUR and P. R. BRAY, M.Sc.(Eng.), Grad.I.E.E. 1938 1/3</p> <p>No. 170. "SUBSCRIBERS' CABLE DISTRIBUTION—RECENT DEVELOPMENTS."—<br/>L. MEEK, A.M.I.E.E. 1939 6d.</p> <p>*No. 171. "MULTI-CIRCUIT CARRIER TELEPHONY."—E. M. RICHARDS, A.C.G.I., B.Sc. (Eng.), M.I.E.E., and F. J. D. TAYLOR, B.Sc. (Eng.). 1938 1/6</p> <p>No. 172. "CORROSION AND COMMUNICATIONS."—C. E. RICHARDS, F.I.C. 1939 6d.</p> | <p>No. 173. "AUDIO-FREQUENCY RIPPLE FROM D.C. POWER SUPPLIES IN COMMUNICATION ENGINEERING."—<br/>H. R. HARBOTTLE, B.Sc., D.F.H., M.I.E.E., J. A. SHEPPARD, B.Sc., A.M.I.E.E., and D. L. RICHARDS, B.Sc. 1939 1s.</p> <p>No. 174. "METALLURGY AND COMMUNICATIONS."—E. V. WALKER, B.Sc., A.R.S.M. 1940 6d.</p> <p>No. 175. "TELEPHONE EXCHANGE POWER PLANT DEVELOPMENT TRENDS AND WAR-TIME PROBLEMS."—W. J. MARSHALL. 1940 1s.</p> <p>No. 177. "RECENT APPLICATIONS OF THE QUARTZ AND X-RAY SPECTROGRAPHS TO POST OFFICE PROBLEMS."—R. TAYLOR, M.A., Ph.D., B.Sc. 1941 1s.</p> <p>No. 179. "INTRODUCTION OF U.A.X. MULTIMETERING IN THE LEEDS AREA."—<br/>H. G. COPE. 1941 1s.</p> <p>No. 180. "SUBSCRIBERS' CABLE DISTRIBUTION—SOME FURTHER CONSIDERATIONS."—F. SUMMERS, A.M.I.E.E. 1944 1s.</p> <p>*No. 181. "POST-WAR EXCHANGE DESIGN."—<br/>H. E. FRANCIS, A.M.I.E.E. 1943 1s.</p> <p>*No. 182. "LONDON INLAND TRUNK SERVICES."—W. H. SCARBOROUGH, A.M.I.E.E. 1943 1/6</p> <p>*No. 183. "FREQUENCY MODULATION."—<br/>J. H. H. MERRIMAN, M.Sc., A.Inst.P., A.M.I.E.E., and R. W. WHITE, B.Sc., F.Inst.P., A.M.I.E.E. 1945 1/6</p> <p>*No. 184. "THE FUNDAMENTALS OF DIRECT CURRENT IMPULSING IN MULTI-EXCHANGE AREAS."—S. WELCH, M.Sc.(Eng.), A.M.I.E.E. 1944 1/6</p> |
|---|--|

\* The Council have awarded Institution Medals for these papers.

# G.E.C.

*supply & install Everything for*

**ELECTRICAL COMMUNICATIONS**

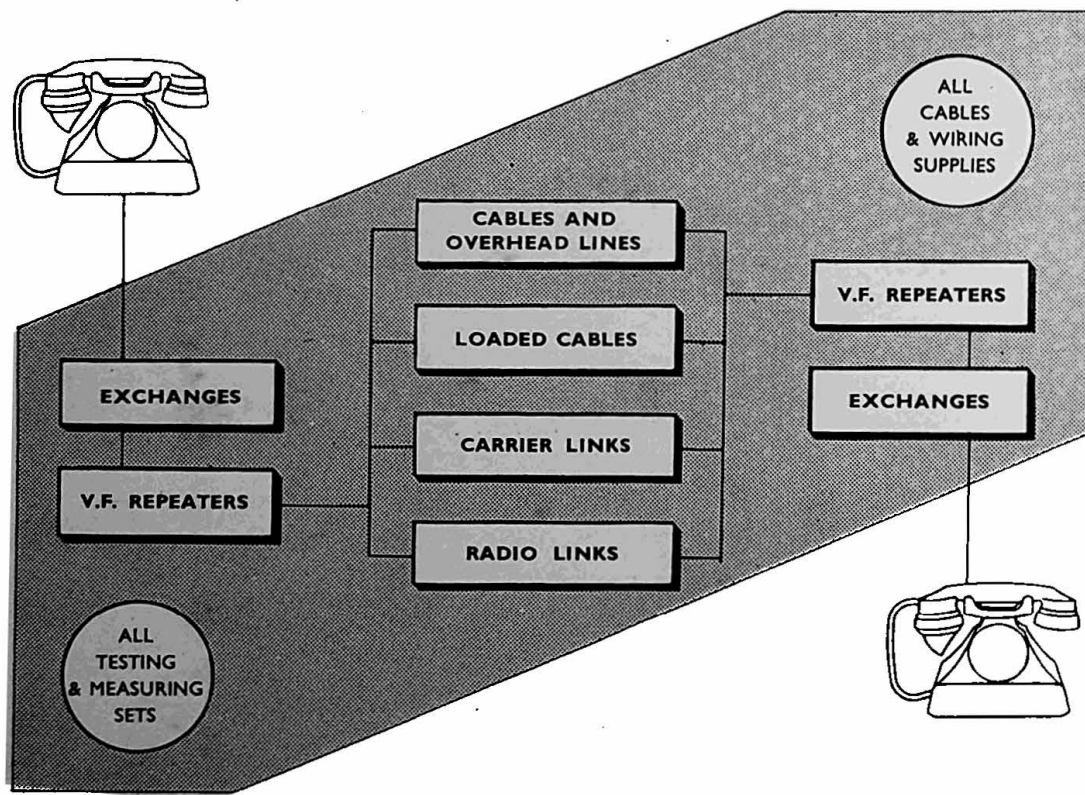

**THE GENERAL ELECTRIC CO. LTD. OF ENGLAND**

**Head Office: MAGNET HOUSE, KINGSWAY, LONDON, W.C.2, ENGLAND**

WAVEMETERS

OSCILLATORS

CONDENSERS

INDUCTANCES

RESISTANCES

**H. W. SULLIVAN**  
— LIMITED —

London, S.E.15

Tel. : New Cross 3225 (P.B.X.)

## Electrical Standards for Research and Industry

Testing and Measuring Apparatus  
for Communication Engineering

BRIDGES — Capacitance  
Inductance  
Resistance

ALL TYPES — ALL FREQUENCIES — ALL ACCURACIES

# ELLIOTT

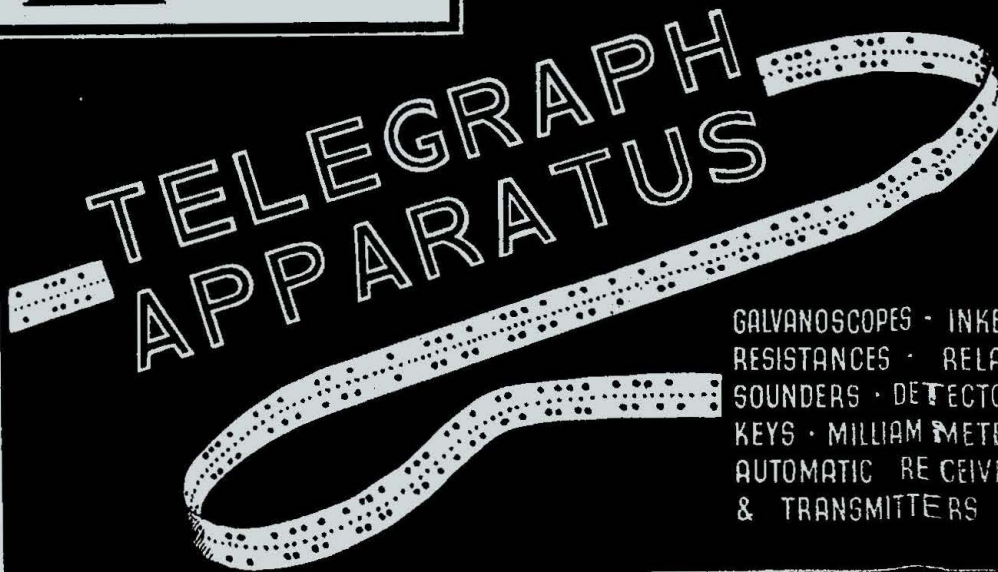

GALVANOSCOPES · INKERS  
RESISTANCES · RELAYS  
SOUNDERS · DETECTORS  
KEYS · MILLIAM METERS  
AUTOMATIC RECEIVERS  
& TRANSMITTERS ETC

**ELLIOTT BROTHERS**  
**[LONDON]**  
CENTURY WORKS  
TELEPHONE

# MAINTAINING EFFICIENCY

THE HIGH STANDARD OF EFFICIENCY  
OF PIRELLI - GENERAL TELEPHONE  
CABLES IS MAINTAINED BY THE  
CONTINUOUS RESEARCH WORK OF  
AN EXPERIENCED TECHNICAL STAFF.

TELEPHONE:  
SOUTHAMPTON  
2141 (5 lines).

**PIRELLI-GENERAL**  
CABLE WORKS, Ltd., SOUTHAMPTON.

TELEGRAMS:  
PIREKAYBEL  
SOUTHAMPTON

THE SOLDER WITH 3 CORES OF NON-CORROSIVE FLUX,  
PREFERRED BY LEADING MANUFACTURERS OF TELEPHONE  
EQUIPMENT ● SUPPLIED UNDER CONTRACT TO THE G.P.O.

## ERSIN MULTICORE

The Leading manufacturers of Telephone apparatus realise that ERSIN MULTICORE SOLDER is superior to all other types of Solder for assembly and maintenance purposes. The 3 cores of non-corrosive flux ensure flux continuity, extra rapid melting and speedy soldering. High precision standard of soldered joints is obtained with the utmost economy of labour and material. ERSIN MULTICORE SOLDER

is made in a wide range of alloys and gauges to meet all specifications. If you do not already enjoy the advantages of ERSIN MULTICORE SOLDER please write for comprehensive technical information and free samples.



MULTICORE SOLDERS LTD., MELLIER HOUSE, ALBEMARLE ST., LONDON, W.1. Tel: REGent 1411 (P.B.X. 4 lines)

MULTICORE SOLDERS LTD., Mellier House, Albemarle Street, London, W.1. Telephone: REGent 1411 (P.B.X. 4 lines)

Printed by SANDERS PHILLIPS & CO., LTD., The Baynard Press, Chryssell Road, London, S.W.9, and  
Published by BIRCH & WHITTINGTON (Prop. Dorling & Co. (Epsom), Ltd.), Epsom, Surrey.