

THE POST OFFICE ELECTRICAL ENGINEERS' JOURNAL

VOL. 34

OCTOBER, 1941

PART 3

CONTENTS

	PAGE
CARRIER SYSTEM No. 7—F. J. D. Taylor, B.Sc.(Eng.). Part I. ..	101
SERVICES IN A MODERN P.O. BUILDING—R. S. Phillips, A.M.I.E.E. . .	109
THE PHASE CYCLOMETER—H. T. Mitchell, A.M.I.E.E., and T. Kilvington, B.Sc.(Eng.) ..	115
PRINCIPLES OF DESIGN OF SMOOTHING CHOKES—R. O. Carter, M.Sc., A.M.I.E.E., and D. L. Richards, B.Sc.(Eng.) ..	118
THE PRODUCTION OF THE POST OFFICE ELECTRICAL ENGINEERS' JOURNAL—H. Leigh, B.Sc.(Eng.), A.M.I.E.E. ..	126
THE ECONOMIC DESIGN OF MANHOLES—J. P. Harding, B.Sc.(Eng.) Part III—Design of a Typical Manhole ..	133
A SIMPLE INTRODUCTION TO THE USE OF STATISTICS IN TELECOMMUNICATIONS ENGINEERING—J. F. Doust and H. J. Josephs, F.S.S., A.M.I.E.E. Part III—The Poisson Probability Law ..	139
NOTES AND COMMENTS ..	145
REGIONAL NOTES ..	147
THE INSTITUTION OF POST OFFICE ELECTRICAL ENGINEERS ..	148
STAFF CHANGES ..	149

Price 1/- net

THE INSTITUTION OF POST OFFICE ELECTRICAL ENGINEERS

G.E.C.

CRYSTAL CALIBRATOR



A new precision instrument for the rapid and accurate checking and adjustment of radio frequency oscillators, receivers, transmitters and similar apparatus.

It is crystal controlled and A.C. mains operated.

Ask for full information from :

SALFORD ELECTRICAL INSTRUMENTS LTD.

SALFORD. Telephone : Blackfriars 6688 (6 lines). Telegrams and Cables : "SPARKLESS, MANCHESTER"

PROPRIETORS: THE GENERAL ELECTRIC CO., LTD.

EDISWAN

TELEPHONE LINE PROTECTOR PANELS

EDISWAN-SHOTTER-GREETHAM PATENT

(British Patent No. 353924)

for the protection of telephone systems against surges induced by faults on neighbouring power lines

Of the difficulties attendant upon the employment of overhead systems one of the most serious is to ensure uninterrupted working of the telephone system, by providing adequate protection against induced surges caused by switching or line faults in adjacent power lines or by lightning.

The Ediswan Patent Protectors provide the solution. They are inert at the normal working pressure of the telephone line, they keep the voltage on the line down to a pre-determined figure by providing a path of low resistance to earth whereby the surge is cleared and they again become inert immediately the surge is cleared.

They ensure simultaneous discharge of both lines and are capable of clearing heavy discharges without detriment to the system or the protector.

Ediswan Telephone Line Protectors have now been in use by Supply Companies for many years.

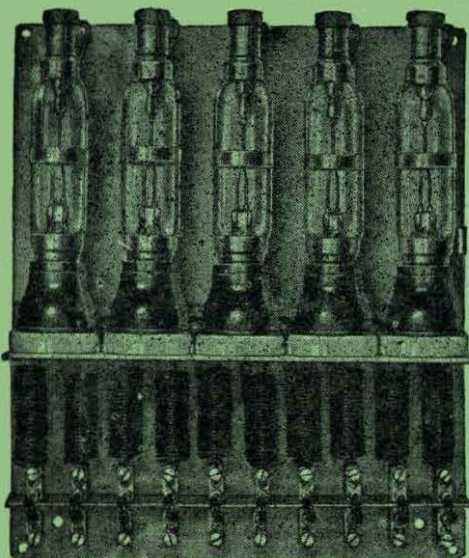

5-circuit panel for overhead lines Incorporating choke coils, spark gaps, etc.

THE EDISON SWAN ELECTRIC CO. LTD., 155 CHARING CROSS ROAD, LONDON, W.C.2

SIMPLIFIED SERVICING MAINTENANCE & FAULT FINDING



46 Ranges
of
Direct
Readings

BRITISH MADE

DESIGNED by technicians who have made a special study of the service and maintenance engineers' problems, the Model 7 Universal AvoMeter is acknowledged throughout the world as the one indispensable combination testing instrument. A single meter, yet at the touch of two simple switches it provides for any one of the 46 ranges of measurements for testing and tracing all electrical faults.

Entirely self-contained, the Model 7 Universal AvoMeter is essentially portable and, above all, simple to use. It is dead-beat in action, has a 5-inch hand-calibrated scale with anti-parallax mirror, and conforms to B.S. 1st Grade accuracy requirements. It is fully protected by an automatic cut-out against damage through overload.

Also available

Model 7 Resistance range Extension Unit
(for measurements down to 1/100th ohm.)

40-range Universal AvoMeter

Some delay in delivery of Trade orders is inevitable, but we shall continue to do our best to fulfil your requirements as promptly as possible.

● Write for fully descriptive literature and current prices.

Proprietors and Manufacturers —

The Automatic Coil Winder & Electrical Equipment Co., Ltd.,
Winder House, Douglas Street, London, S.W.1. Telephone: Victoria 3404/7

VOLTAGE			
A.C.		D.C.	
Range.	Value per division	Range.	Value per division
0- 5 Volts	50 mV.	0- 50 mV	0.5 mV.
0- 10 "	100 "	0- 100 mV	1 "
0- 50 "	500 "	0- 500 mV	5 "
0- 100 "	1 Volt	0- 1 Volt	10 "
0- 200 "	2 "	0- 5 "	50 "
0- 400 "	4 "	0- 10 "	100 "
0- 500 "	5 "	0- 50 "	500 "
0-1,000 "	10 "	0- 100 "	1 Volt
		0- 200 "	2 "
		0- 400 "	4 "
		0- 500 "	5 "
		0-1,000 "	10 "

CURRENT			
A.C.		D.C.	
Range.	Value per division	Range.	Value per division
0- 5 mA	50 μ A	0- 1 mA	10 μ A
0- 10 "	100 "	0- 2 "	20 "
0- 50 "	500 "	0- 5 "	50 "
0-100 "	1 mA	0- 10 "	100 "
0-500 "	5 "	0- 50 "	500 "
0- 1 Amp.	10 "	0-100 "	1 mA
0- 5 "	50 "	0-500 "	5 "
0- 10 "	100 "	0- 1 Amp.	10 "
		0- 5 "	50 "
		0- 10 "	100 "

RESISTANCE	
Range.	First indication.
0-10,000 ohms	0.5 ohms
0-100,000 "	5 "
0- 1 megohm	50 "
0-10 "	500 "
0-40 "	2,000 "

using internal 1½-volt cell.
using internal 9-volt battery.
using external source of A.C. or D.C. voltage.

CAPACITY	POWER	DECIBELS
0 to 20 mFd.	in 4,000 Ω internal resistance	reference level 50 mW
First indication 0.01 mFd.	0 to 4 watts First indication 1 mW	-10 Db. to +15 Db.

The 46-RANGE UNIVERSAL

AVOMETER

Reqd. Trade Mark

Electrical Measuring Instrument

Model 7

*. . . high grade
manufacturers
of everything
in the
telephone
communication
field*

G.E.C.

REGD. TRADE MARK

TELEPHONE
WORKS

**The General Electric Co., Ltd.,
Head Office :- Magnet House,
Kingsway, London, W.C.2**



UIC

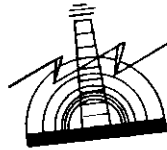

UNSURPASSED
INSULATING
COMPONENTS

• CERAMIC FIXING PLATES

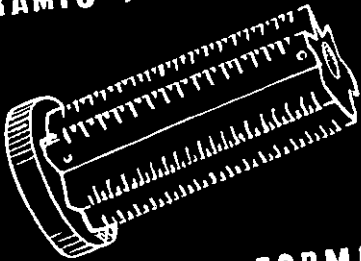

• CERAMIC COIL FORMERS

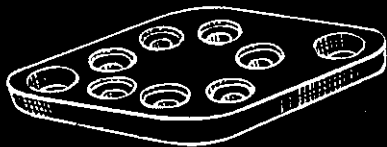

• CERAMIC VALVE HOLDER BASES

For modern Radio Technique

Full details and advice gladly given

UNITED INSULATOR CO. LTD.

12-16 LAYSTALL STREET, LONDON, E.C.1

'Phone : TERminus 4118-9.

'Grams : CALANEL, SMITH, LONDON.

CONTRACTORS TO G.P.O. AND GOVERNMENT DEPARTMENTS.

ON A.I.D. APPROVED LIST.

The Pioneers of Low-loss Ceramics



ELECTRICAL

Manufa

TELEPHONE CABLES

Aerial, Underground, Submarine

LOADING COILS

ELECTRIC WIRES & CABLES

of all types

CABLE JOINT BOXES

OVERHEAD LINE MATERIAL

MARINE APPARATUS

WIRELESS EQUIPMENT FOR SHIPS

Contractors for the
laying and
maintenance of
Submarine
and
Land Cables
for
Telegraphy,
Telephony
and
Power Transmission.

SIEMENS BROTHERS

WOOLWICH

Telephone : C



PRODUCTS

Manufacturers of

PUBLIC TELEPHONE EXCHANGES

PRIVATE TELEPHONE SYSTEMS

ELECTRIC TOTALISATORS

CELLS & BATTERIES

Dry, Fluid and Inert

MEASURING & RECORDING
INSTRUMENTS

ELECTRICITY METERS

ELECTRIC LAMPS

Contractors for the
erection and
maintenance of
Marine Wireless
Installations,
Public and
Private Telephone
Exchanges,
and
Carrier Equipment
for
Telephone Lines.



TH & CO. LIMITED

CH, DON, S.E.18

Phone : CH 2020.

capco

REGISTERED TRADE MARK

Quartz Cutting Machine

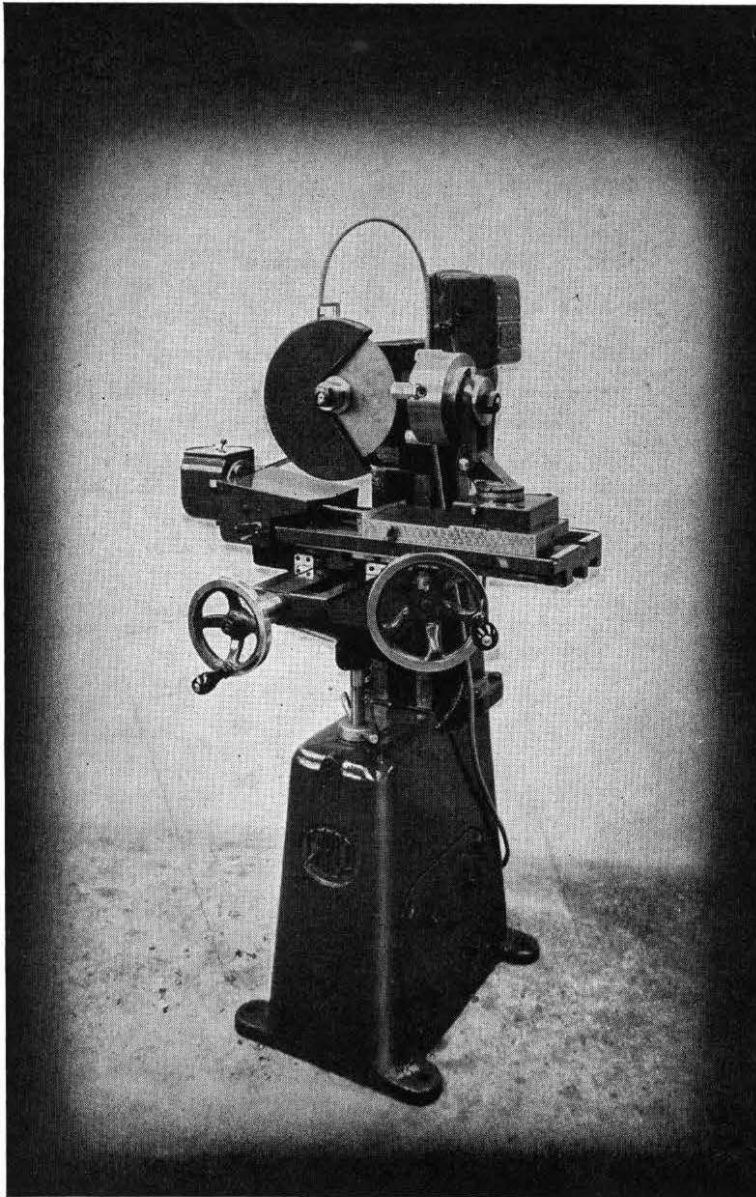

Illustration shows latest Model of the Quartz Cutting Machine developed and designed in collaboration with engineers of the Radio Branch of the Post Office.

Similar machines have been supplied to the Post Office and to the leading Telephone and Radio Manufacturers.

Standard and heavy duty cutting machines with high rates of cutting to accuracies of .001 in.

Fixtures to hold any shape of crystal can be supplied.

Heavy Duty Machine can now be supplied with nine rates automatic feed through specially designed gear box, sensitive instantaneous stop through specially designed clutch.

Acknowledged to be the finest machines of their kind for this class of work.

Manufacturers :

CAPLIN
ENGINEERING CO. LTD.

Precision Engineers

BEACONSFIELD RD., WILLESDEN
LONDON, N.W.10

Telephone :
WILlesden 0692.

Cables :
Caplinko, London.

ESTABLISHED 1918

Sole Agents : CAPCO (SALES) LTD.

Designers and Manufacturers of Capco Sound-on-Film recorders and equipment. Capco built recorders are in use at Elstree, Pathe News and British Talking Pictures, etc. Patentees and Manufacturers of Capco Enamelled Wire cleaning machines.

WIFE

COUNTER E.M.F. CELLS

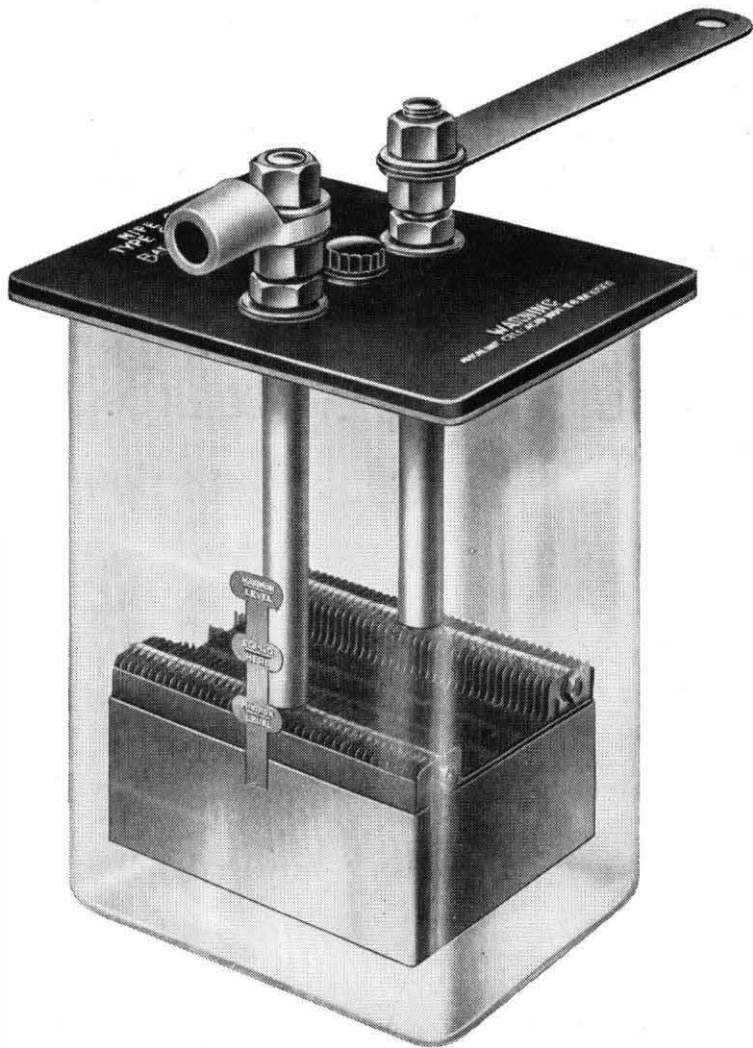

- Alkaline with Inert Plates.
- Very level voltage characteristic independent of direction and almost independent of magnitude of current.
- Zero capacity and complete absence of formation giving prolonged life of switch contacts.
- No corrosive fumes allowing installation adjacent to either lead acid or alkaline batteries without detriment to either.
- Very low maintenance.
- Extremely long life.

NIFE BATTERIES
LIMITED

HUNT END WORKS · REDDITCH · WORCESTERSHIRE

PRECISION

Notwithstanding the difficulties met with under present conditions, the Telephone Manufacturing Company, Ltd., is maintaining the well-known reliability of its condensers. These are manufactured in a modern condenser plant, and are notable for the following features :—

Rigid construction.
Small size and weight.

Extreme stability.
Low temperature co-efficient of capacity.
High insulation resistance.

Maintenance of initial capacitance values.

Low power factor.
Adequate safety factor, and
Long life.

Only high grade materials are used, which have been proved to be suitable by chemical, physical and electrical tests, and careful supervision is given at all stages of manufacture.

Enquiries are solicited in respect of the following types :—

(a) Mica Condensers.

These are manufactured in copper or other metal cans, as required, which are marked with the actual and nominal capacities. They may be supplied and adjusted to within $\frac{1}{2}$ per cent. from the nominal capacity. The temperature co-efficient is not greater than .0045 per cent. and the power factor at 1,000 cycles/second is not greater than .001.

(b) Precision Paper Condensers.

These are of the oil impregnated, oil filled, clamped paper dielectric type. The capacity is adjusted to within 2 per cent. of the nominal capacity and departures from the actual capacity due to temperature variations from 0 deg. C. to 50 deg. C. are not greater than 2 per cent. These condensers are fitted with terminals constructed from Mica-filled bakelite and having an insulation of not less than 10,000 Megohms at normal temperature and humidity.

Prompt attention given to enquiries and deliveries expedited.

TELEPHONE MANUFACTURING COMPANY LTD. WEST DULWICH, S.E.21

View of a corner of the Condenser Test Department (gauging thickness of mica.)



THE POST OFFICE ELECTRICAL ENGINEERS' JOURNAL

Vol. XXXIV

October, 1941

Part III

Carrier System No. 7

F. J. D. TAYLOR, B.Sc.(Eng.)

Part I

U.D.C. 621.395.443.3

This article is concerned with the latest type of 12-circuit carrier system now being introduced in the trunk network of this country ; it deals with the reasons underlying the introduction of a new system, with the basic features, the requirements laid down for the performance and certain other miscellaneous features. A subsequent article will deal with more of the circuit details and give figures showing the performance of installations employing the new equipment.

General.

THE No. 7 carrier system is the successor of those of the Nos. 5 and 6 types¹ and supersedes those systems. Basically it is a system designed to provide for the transmission of a group of twelve circuits upon pairs in cables designed specifically for what has become known as "12-circuit working." At the same time it is designed to provide many special facilities and incorporates features resulting from experience with the earlier systems.

At the 1938 meeting of the C.C.I.F., which was held at Oslo, there were tabulated certain recommendations regarding the performance of 12-circuit carrier equipment as used in connection with the provision of international circuits. Fundamentally the recommendations were as follows:—(1) The twelve channels of a group assembled in the frequency range 12 to 60 kc/s should be the erect sidebands of the twelve virtual carrier frequencies 12, 16, 56 kc/s. (2) The range of frequencies transmitted effectively should extend, for each channel of the group, from 0.3 to 3.4 kc/s.

Actually, the systems in use in this country at the time of the Oslo conference did not meet the requirements indicated above; the No. 5 and 6 systems use the lower sidebands (i.e. frequencies transmitted to line) of the carrier frequencies 16, 20, 60 kc/s and, in addition, they are designed to provide an effective transmission range per channel from 0.3 to 2.6 kc/s. That the C.C.I.F. had recommended for international use a system, the performance of which differed from that in use in this country, did not necessarily mean the abandonment of the systems in use but it was clearly necessary to examine if a change of system was warranted. Briefly, the retention of the existing systems meant that the introduction of another system would be avoided, that the general use of inverter equipment would be unnecessary, and that it would be necessary to use special systems only on 12-circuit routes connecting terminals in this country with points abroad. On the other hand there were advantages in introducing a new system and these were as follows:—

(1) The two systems in use (Nos. 5 and 6) were very

different in construction and it was apparent that a new and more standardised system should be introduced at some time.

(2) The performance requirements of the system recommended by the C.C.I.F. meant considerable technical advancement, the broad channel band being particularly attractive.

(3) The firms manufacturing carrier telephone equipment in this country would not be called upon to produce one type of equipment for use in this country and another for export.

(4) It would be possible to introduce new features and improvements shown to be desirable by experience with the earlier types of system.

(5) The form of the new system could be such that it would be suitable for use as the basic group for use in connection with coaxial cable equipments, i.e. it was possible to have a standard 12-circuit group end for use in connection with either the special carrier pair cables or the coaxial cables.

(6) It was likely that a saving of repeater station space could be effected.

After due consideration it was decided that a new system having the performance recommended by the C.C.I.F. should be introduced; the result is the Carrier System No. 7.

Basic Features.

The main problem to be faced in the design of the new system was the greatly increased ratio of frequency range effectively transmitted to bandwidth available per channel. In the earlier systems this was (2.3)/4, whereas that of the new system was (3.1)/4, i.e. adjacent channel suppression had to be accomplished in 0.9 kc/s instead of in 1.7 kc/s. Using filters employing reactors of normal construction this would have been possible if some form of double frequency changing² was employed, but it was apparent that the problem would be most easily solved by using quartz (or similar) crystals as certain of the filter reactors³.

With crystals of normal construction it is not desirable to use elements resonating at frequencies much below 60 kc/s; if this limit is exceeded the

²G.E.C. Journal, Vol. 9, p. 48.

³P.O.E.E.J., Vol. 31, p. 254.

crystals become too large. It was therefore decided to form the group initially in the frequency range 60 to 108 kc/s and to group frequency change the whole group to place it into the range 12 to 60 kc/s; this latter step can be effected with the aid of a group carrier frequency of 120 kc/s. The choice of this particular arrangement was governed by the following factors:—

(1) A sub-committee of the C.C.I.F. which had met in London in December, 1938, had recommended that one of the basic groups for use in

Tests on cables laid for 12-circuit working had shown that it was possible to adjust far-end crosstalk values so that the transmission of line frequencies up to 108 kc/s was practicable; on certain cables it was found that the far-end crosstalk values could be made so good that working to frequencies much in excess of this figure was possible. With a view to utilising this cable properly it was decided so to arrange the layout of the No. 7 type equipment that, if and when necessary, 24 channels could be transmitted on one cable pair; it is apparent that

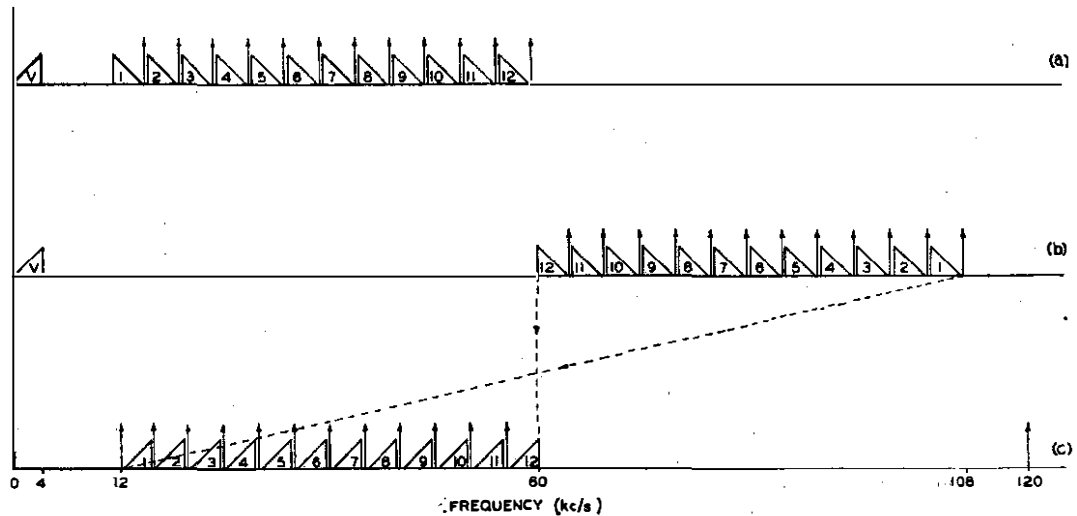

FIG. 1.—FREQUENCY SPECTRA USED IN SYSTEMS NOS. 5, 6 AND 7.

connection with systems designed to use coaxial cables should employ the range 60 to 108 kc/s, the channels being assembled as the lower sidebands of the carrier frequencies 64, 68, 108 kc/s. A twelve channel group employing this particular range after one frequency changing stage was therefore suitable for use as a basic group on coaxial cable systems.

(2) Within the frequency range concerned the design of filters presented no particular difficulties and the band width to mid-band frequency ratio was not too small.

(3) As the range of frequencies (60-108 kc/s) was less than one octave the group frequency changing stage was unlikely to cause undue inter-channel interference.

Fig. 1 shows in diagrammatic form the frequency spectra used in the Nos. 5, 6 and 7 systems. Fig. 1(a) represents the spectrum concerned in the No. 5 and 6 systems; "V" indicates a voice band approximately 4 kc/s wide, the vertical arrows the real or virtual carrier frequencies and the twelve numbered triangles the twelve channels as transmitted to line. Fig. 1(b) illustrates the assembly (as in the No. 7 system) of twelve channels in the frequency range 60 to 108 kc/s, the channel frequencies being "inverted" with respect to the modulating frequencies. Fig. 1(c) indicates the inversion and frequency shifting accomplished by modulating the band of Fig. 1(b) by a carrier frequency of 120 kc/s and selecting the lower sideband.

this arrangement involves the omission of the group frequency changing stage from one of a pair of channel equipments and for the provision of equip-

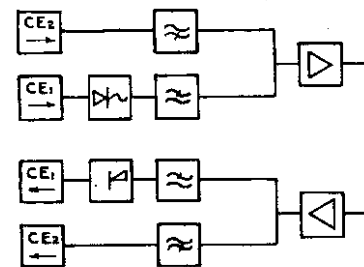

CE₁ - CHANNEL EQUIPMENT OF GROUP TRANSMITTED IN THE RANGE 12-60 kc/s
CE₂ - CHANNEL EQUIPMENT OF GROUP TRANSMITTED IN THE RANGE 60-108 kc/s

FIG. 2.—TERMINAL STATION WORKING ON "24 CHANNEL BASIS."

ment (filters) to combine the two groups. The arrangement of terminal station equipment working on a "24 channel basis" is illustrated in Fig. 2. The frequencies transmitted to line are, of course, those of the normal twelve of the system plus those obtained after one stage only of frequency changing,

i.e. those of Figs. 1(b) and 1(c). Cable attenuation at 108 kc/s is such that, using line amplifiers having a gain of 65 db. the maximum repeater spacing is 16.0 miles compared with 22.0 miles when the maximum transmitted frequency is 60 kc/s; existing routes laid down on a basis of 22 mile spacing do not, therefore, lend themselves immediately to 24-circuit working. Certain new routes will be laid down with the maximum spacing of 16 miles.

The possibility of working on a 24-circuit basis made it necessary to introduce new line amplifiers as those in use in connection with the Nos. 5 and 6 systems will not transmit effectively at frequencies much in excess of 60 kc/s. At a later stage consideration will be given to the design of this amplifier.

Performance Requirements.

When the design of the new system was considered the following performance requirements were taken into account:—

(1) When used in conjunction with pairs in the 12 quad carrier type cable of standardised design and amplifiers spaced at suitable intervals the equipment should be capable of providing either 12 or 24 channels per pair.

(2) The system should operate on a 4-wire basis separate cables being used for the "go" and "return" directions of transmission.

(3) The end-to-end frequency response of all channels should be within the limits shown in Table 1.

TABLE 1.

Frequency c/s	300-400	400-500	600-2400	2400-3000	3000-3400
Loss in decibels relative to that at 800 c/s.	+5.7 to -1.1	+2.9 to -1.1	+1.1 to -1.1	+2.9 to -1.1	+5.7 to -1.1

(4) The audio to sideband and sideband to audio response of the channel equipment should be in accordance with Table 2.

TABLE 2.

Audio input Freq. (or corresponding Virtual side Freq.)	300-400	400-600	600-2400	2400-3000	3000-3400
Loss in decibels relative to that at 800 c/s or corresponding Virtual side Freq.	+4.3 to -0.85	+2.15 to -0.85	+0.85 to -0.85	+2.15 to -0.85	+4.3 to -0.85

(NOTE.—The Contractors concerned were advised that the performance limits indicated in tables 1 and 2 would be considered as applying only until a sufficient number of equipments had been made to determine just how far these limits could be tightened without making the apparatus impossible from a manufacturing point of view.)

(5) Noise, however caused, should not exceed 2 millivolts (E.M.F.) as measured on a circuit noise measuring instrument weighted in accordance with the relevant C.C.I.F. recommendations, the measurement being made at a point of zero relative test level.

(NOTE.—The "relative test level" at a point is the power level which would exist at that point were 1 milliwatt applied at the 2-wire input terminals of a circuit via a differential transformer having a 2-wire to 4-wire loss of 4 db. Transmission terms

and definitions have recently been reviewed having regard to the C.C.I.F. recommendations and in future quantities quoted as "relative test levels" in this article may be referred to either as "relative levels" or "test levels" according to the terms of the new definitions. The present term has been used because those which may supersede it are not yet in general use.)

(6) The system should be designed to operate satisfactorily with the input test level at the 4-wire point of any channel at any value between -13.5 and +10 db. with reference to 1 mW in 600 ohms. The impedance at the 4-wire input point of a channel should be 600 ohms.

(7) With the input levels mentioned under (6) the design of the receiving portion of the channel equipment should be such that the 4-wire output level could be varied in steps of 1 db. (± 0.25 db.) to any value between 0 and +10 db. with respect to 1 mW in 600 ohms. The impedance at the 4-wire output point should be 600 ohms.

(8) The sum of the carrier leaks from 24 channels should be at least 12 db. below the relative test level per channel when measured at the output of the channel equipment.

(9) The relative test level at the output of the transmitting line amplifier should be sensibly equal to +5 db. with respect to 1 mW.

(10) Points of flexibility (jumping frames) should be provided at certain points so that flexibility of channel, group and line equipment could be attained.

(11) Line amplifiers should be capable of operating efficiently over the frequency range 12 to 108 kc/s. They should have a maximum gain of 65 ± 1 db., the gain being adjustable over the range 45 to 65 db. The input and output impedances should be sensibly equal to 600 and 140 ohms, respectively, the return loss against these impedances being a minimum of 20 db. in each case. With an output level of 25 db. in excess of 1 mW the harmonic suppression should be at least 55 db. The overload point should be at least 30 db. in excess of 1 mW. The amplitude distortion should be such that the amplifier gain does not change by more than 0.5 db. when the output level varies from -40 to +10 db. with respect to 1 mW. It is required that the amplifier does not oscillate under working conditions.

(12) The equalisation of attenuation distortion should be such that at any station the residual distortion does not exceed 4 db. over the frequency range concerned and at stations where an H.F. repeater distribution frame is installed (see later) the residual distortion should not exceed 2 db.

(13) The carrier frequency generating equipment should be capable of providing the carrier frequency supply for 48 channel and group equipments. It should also be capable of transmitting a 60 kc/s signal on 24 cable pairs.

(14) The carrier frequency generating equipment should be capable of being controlled by a high accuracy 1 kc/s source or by a 60 kc/s signal received from another station. The design of the carrier frequency synchronising equipment should be such that it is not affected by the presence of sideband

signals on the line carrying the synchronising current. The carrier generating equipment should be capable of sending a synchronising tone on any or all cable pairs and being controlled by tone received from any cable pair.

Reasons for choosing the Performance Requirements specified.

Consideration will now be given to the factors underlying the foregoing requirements.

Requirements (1) and (2) are self explanatory. As for (3), the end-to-end channel response required is two-thirds of that recommended by the C.C.I.F. for an international circuit; actually it is desired to obtain a response superior to this but, as indicated earlier, the figures shown were taken as being satisfactory for initial designs. The requirement for the audio to sideband and sideband to audio response is such that, with a group formed of two channel equipments of different manufacture, the overall end-to-end response is not likely to be inferior to that of require-

crosstalk) be measured with certain levels of interfering signal; it is required that the interfering signal shall be speech on two channels disturbing at a level of 4 db. below R.T.P.

At first sight it would appear that the levels which may be applied at the 4-wire input point are unduly wide (requirement (6)). Actually these were chosen bearing in mind these factors; the test level at the output of an audio 4-wire repeater is +10 db. relative to 1 mW and it may be desired to extend an audio circuit on a carrier basis without providing special attenuators and without using non-standard levels; under pad switching conditions (and this is the limiting condition) the level available at the 4-wire input point may not exceed -13.5 db.

The range of output levels mentioned in requirement (7) is such that a carrier circuit may be extended on an audio basis and still provide the standard test level on the 4-wire line and, in addition, directly terminated circuits may be adjusted to have a 2-wire to 2-wire loss of 0 to -4 db.; if used with 3 db. 2-wire

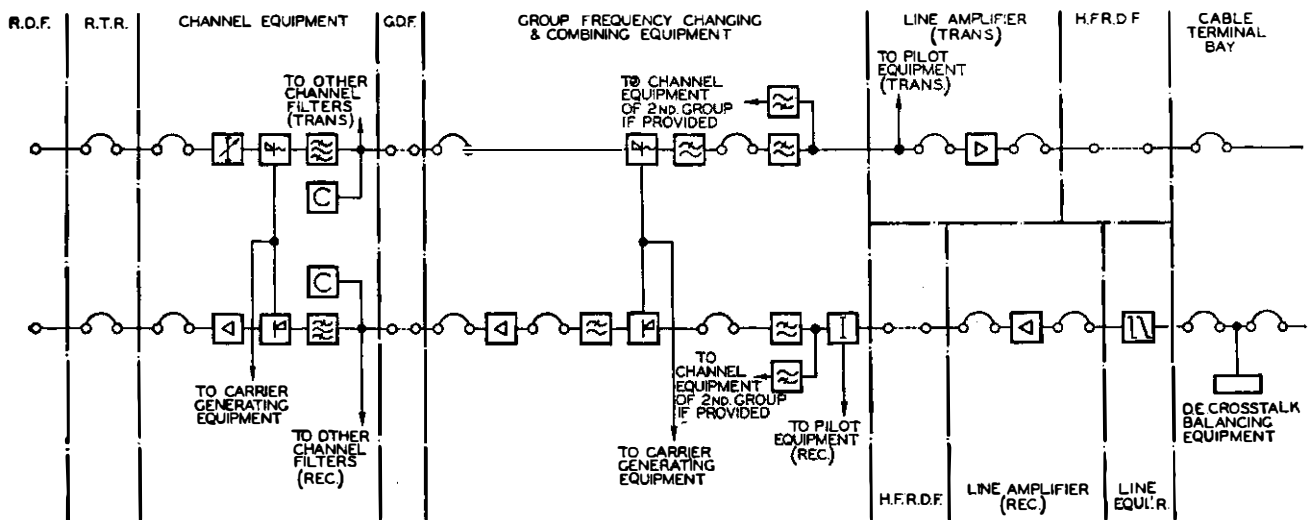

FIG. 3.—TERMINAL STATION—BLOCK SCHEMATIC DIAGRAM.

ment (3). After experience with the first few group ends of the new design it is hoped that it will be possible to make the audio to sideband and sideband to audio response requirements 50 per cent. of the end-to-end requirements.

The limit for factor (5) is considerably superior to that recommended by the C.C.I.F. for international circuits. The figure of 2 mV of total noise at a point of zero relative test level was decided upon as a result of experience with earlier multi-channel carrier systems; usually the channel noise is likely to be very much less than the specified maximum figure. The 2 mV E.M.F. (1 mV P.D. at a 600 ohm point) is intended to cover unwanted interference however produced and includes intelligible crosstalk, unintelligible crosstalk, noise from power supplies, valve noise, thermal agitation (Johnson) noise, intermodulation products, etc. As intermodulation is a function of loading the specifications concerned require that inter-channel interference (within-group

extensions at each end of that portion of a circuit provided on a 12-circuit basis it is still possible to obtain a zero loss circuit.

The requirement in connection with carrier leak is such that with reasonable changes in rectifier bridges when in service, the total carrier leak shall not be of such a level as to interfere with routine channel level measurements or such as to cause undue loading of the line amplifiers.

Requirement (9) is bound up with the overload point of the type of line amplifier employed and with the number of channels to be handled simultaneously. Much research has been done and much written on the relationship between channel test level, number of channels to be handled simultaneously and amplifier characteristics; the channel test level specified was determined after taking into account the known factors and also after reviewing experience with the amplifiers used on earlier multi-circuit carrier systems.

On the earlier 12-circuit carrier installations it had

been found necessary to provide a point of flexibility at the junction of line and terminal equipment; it was obviously desirable that this point, the high frequency repeater distribution frame (H.F.R.D.F.)

various types of equipment are indicated in Fig. 4. Broadly, the H.F.R.D.F. permits the interconnection of apparatus handling the frequency range 12 to 60 kc/s whereas the G.D.F. permits interconnection at the 60-108 kc/s point. On the H.F.R.D.F. it was possible to arrange that under all circumstances the nominal channel test level at that point was +5 db. with respect to 1mW; on the G.D.F. it was found impossible to arrange for a common test level and this may vary from about -8 to -36 db. with respect to 1 mW. Another factor of interest in connection with the distribution frames is that all apparatus connected to the H.F.R.D.F. has a nominal impedance of 140 ohms (balanced) whereas that connected to the G.D.F. has an impedance of 75 ohms (unbalanced). The impedances concerned are the approximate characteristic impedances of the pair type and coaxial type cables most often used. Jumpers on the H.F.R.D.F. must be of pair type (screened), whereas those on the G.D.F. are of coaxial form.

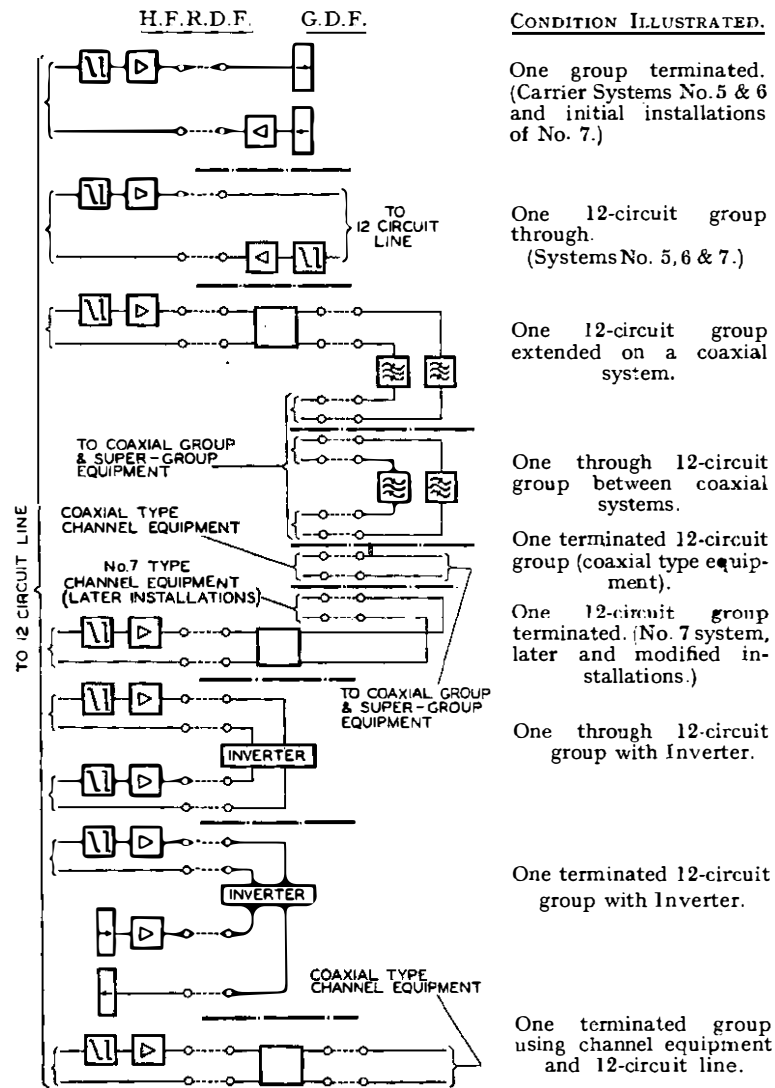

FIG. 4.—H.F.R.D.F. AND G.D.F. WITH SCHEMATIC ARRANGEMENTS OF TYPICAL CIRCUITS.

should also be made available in connection with the new equipment. In addition, the use of the 60-108 kc/s basic group of the No. 7 type channel equipment made it available for forming basic super-groups for transmission on high-frequency (coaxial and like) cables, and made it desirable to provide an additional point of flexibility where the channels were in the 60-108 kc/s range. The second frame is known as the group distribution frame (G.D.F.). The relative positions of the two distribution frames are indicated in Fig. 3, which also shows, in block schematic form, the apparatus items comprising a 12-circuit group end. The ways in which these frames permit the interconnection of

various types of equipment are indicated in Fig. 4. Broadly, the H.F.R.D.F. permits the interconnection of apparatus handling the frequency range 12 to 60 kc/s whereas the G.D.F. permits interconnection at the 60-108 kc/s point. On the H.F.R.D.F. it was possible to arrange that under all circumstances the nominal channel test level at that point was +5 db. with respect to 1mW; on the G.D.F. it was found impossible to arrange for a common test level and this may vary from about -8 to -36 db. with respect to 1 mW. Another factor of interest in connection with the distribution frames is that all apparatus connected to the H.F.R.D.F. has a nominal impedance of 140 ohms (balanced) whereas that connected to the G.D.F. has an impedance of 75 ohms (unbalanced). The impedances concerned are the approximate characteristic impedances of the pair type and coaxial type cables most often used. Jumpers on the H.F.R.D.F. must be of pair type (screened), whereas those on the G.D.F. are of coaxial form.

Concerning requirement (11), the maximum gain chosen was dependent upon a number of factors. Firstly, with the battery voltages available (130 V H.T. and 24 V L.T.) it was not practicable to produce an amplifier having an overload point much in excess of 1 watt (with adequate harmonic suppression); with the number of channels concerned this restricted the test level per channel to about +5 db. with respect to 1 mW. Secondly, with a view to having adequate margin against thermal agitation noise at the point of minimum signal level it was inadvisable to permit the signal level to fall much below 60 db. below 1 mW. (For the bandwidth concerned the weighted noise level is about 139 db. below 1 mW; for a single section signal to noise ratio the signal should not therefore fall below about 79 db. below 1 mW. As doubling the number of repeater sections results in approximately 3 db. degradation of signal to noise it was apparent that, for a large number of repeater sections the minimum signal level should not be far below 60 db. below 1 mW.)

The specified amplifier output impedance is such that a good return loss shall be obtained when the unit is connected to a line having a characteristic impedance which is approximately 140 ohms over the frequency range concerned. The input impedance is such that, in transmitting amplifiers a good filter closure is effected, whereas in through and receiving amplifiers, the equaliser impedance is 600 ohms, the transformation to the cable impedance being effected by a transformer preceding the equaliser. Good return losses must be obtained if reflected near-end crosstalk difficulties are to be avoided. In practice all of the line amplifiers are identical,

with the exception that those immediately preceding the H.F.R.D.F. on the receiving side have continuously variable potentiometers for gain control, whereas all others have potentiometers using soldered connections. The requirement that the amplifier shall not oscillate under working conditions is self explanatory.

The limitation of residual attenuation distortion (requirement 12) is based upon two factors. Firstly, it is undesirable from the point of view of interchannel interference to have too wide a difference of test level for the channels transmitted simultaneously by one amplifier. Secondly, the residual attenuation distortion should not be such that the gain-frequency characteristic of a channel is affected appreciably. The fairly stringent requirement regarding residual attenuation distortion as measured between adjacent H.F.R.D.F.'s is based upon the fact that numbers of such links may be joined in tandem, and it is desired to make as infrequently as possible special equaliser adjustments consequent upon the connection of links in tandem.

In the earlier 12-circuit carrier systems it is possible to operate either 12 or 24 channel equipments from one set of carrier frequency generating equipment; experience has shown that it is desirable that the number of groups "driven" by one set of generating equipment should be larger than this, and the figure of 48 (requirement 13) was chosen bearing this in mind.

When the No. 5 system was designed it was considered unnecessary that there should be absolute synchronism of the carrier supplies at the two terminals of a group; there is negligible distortion to commercial quality speech if there is an asynchronism of not more than about 5 c/s between the carriers at the two ends and hence it was considered necessary to provide only unsynchronised oscillators, such units having adequate inherent frequency stability. When the frequency generating equipment for the No. 6 system was considered it was decided that carrier frequency synchronism should be provided, and a system of transmitted pilot frequencies was adopted¹. Experience with the No. 6 system and experimental work described in this JOURNAL⁴ showed that there were certain disadvantages in carrier synchronising systems employing directly transmitted pilot frequencies which were used to lock directly the controlled oscillators; the defects were (i) that the locking signal might be modulated during transmission and so cause "flutter" in the controlled oscillation and (ii) that, in the event of the failure of the pilot signal, the controlled oscillator(s) became "free" and there was immediate and possibly considerable asynchronism.

Much might have been done with the aid of oscillators of very high accuracy which would have to be provided at every station at which terminal type equipment was installed, but it was considered that in view of 2 V.F. signalling and V.F. telegraph requirements it was preferable to have all oscillator equipments locked.

A further factor which had to be borne in mind when deciding the type of synchronising arrangement

to be used arose as a result of experience with No. 6 installations and with special synchronising arrangements which were provided with a view to making certain carrier routes suitable for carrying 2 V.F. signalling currents. This was the difficulty which arose from time to time as, unlike normal groups, those specially arranged to carry synchronising signals could not readily be rearranged, re-routed or modified as required by service conditions. To overcome this it was arranged that, in the No. 7 system, all equipped pairs should carry synchronising signals, the controlling pair at any terminal station being selected at a jumper field, i.e., all pairs are to be identical as far as synchronising facilities are concerned and apparatus changes may be made with a minimum risk of disturbing the carrier synchronising arrangements.

Synchronising Equipment.

The type of arrangement decided upon is known as the "motor control system." At one station the carrier frequencies generated are an exact multiple of an accurate 1 kc/s source. To control distant terminal stations there would be transmitted on all pairs radiating from this station an accurate 60 kc/s signal (this is neither a real nor virtual carrier frequency). The controlling arrangement at a station receiving the control from the first station is indicated in Fig. 5.

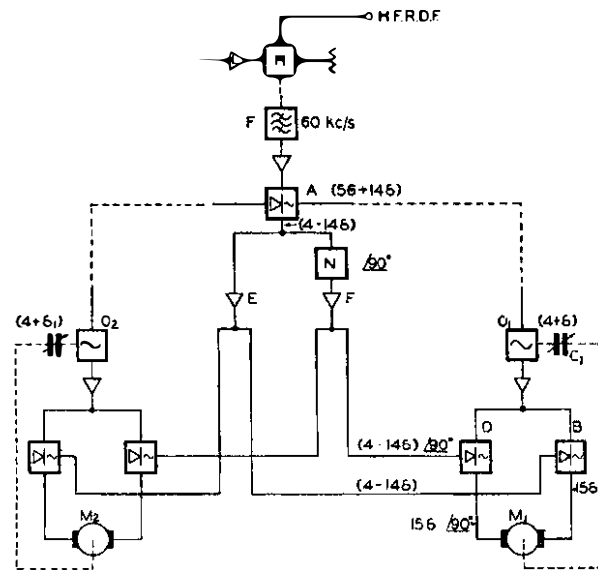

FIG. 5.—SYNCHRONISING CONTROL AT A CONTROLLED STATION.

At the controlled station the 60 kc/s signal is received on all pairs; one of the incoming signals may be directed via a small jumper field to the selecting filter F. After amplification it is applied to a frequency changer network A. The local carrier frequencies are derived by multiplication of the basic frequency generated by the "master" oscillator O_1 or its standby O_2 ; the frequency generated by these oscillators is nominally 4 kc/s and it is the function of the controlling arrangement to ensure that the frequency is accurately 4 kc/s. The frequency generated by O_1 may be actually $(4+\delta)$ kc/s and is dependent upon the value of C_1 , which is a condenser

¹P.O.E.E.J., Vol. 33, p. 75.

in the oscillatory circuit. By the frequency multiplying arrangement employed (this will be described in a later article) the 14th harmonic ($(56+14\delta)$ kc/s) of the fundamental is selected and applied to A. One of the frequencies present at the output of the frequency changer will be $(60-(56+14\delta))=(4-14\delta)$ kc/s. This frequency is applied to amplifiers E and F, but at the input to the latter there is a network N which causes the phase of the input voltage to F to be shifted by 90° with respect to that applied to E. The phase relationship is maintained at the outputs of the amplifiers. The output of each of the amplifiers is split, one "leg" being applied to apparatus associated with O_1 and the other with that associated with O_2 . The output of E will be termed $(4-14\delta)$ and that of F $(4-14\delta)$ 90° ; these currents are applied to frequency changers B and D, respectively, B and D are also fed with current derived from O_1 ; it follows that the outputs will contain currents of frequency $(4+\delta) - (4-14\delta)=15\delta$, and as the relative phases still apply these can be described as 15δ and 15δ 90° from B and D, respectively.

Motors M_1 and M_2 of Fig. 5 are of the form indicated in Fig. 6, B and B representing poles associated with

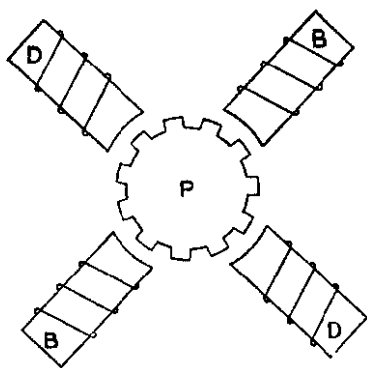

FIG. 6.—ARRANGEMENT OF SYNCHRONISING CONTROL MOTOR.

frequency changer B, and D and D those associated with the frequency changer D. As the currents of frequency 15δ are at right angles with respect to one another it follows that at any instant there will exist in the inter-pole space a field having a particular sense, and this field will rotate at a frequency of 15δ . P is an armature of magnetic material and is hence constrained to move with the field. P is connected mechanically with C_1 and the connection is in such sense that the movement of C_1 decreases the value of δ and hence the motor continues to drive until $\delta=0$; when this condition is reached O_1 is generating exactly 4 kc/s.

To ensure that the standby oscillator is always in a condition to take over the load in the event of the failure of O_1 , it is arranged that this, too, shall be continuously motor-controlled. To effect this the second "legs" of the output of E and F feed frequency changers similar to B and D, but which are associated with O_2 . In this case the wanted frequency derived is $(4+\delta_1) - (4-14\delta)=\delta_1+14\delta$, and

the motor will "drive" until this frequency becomes zero.

It will be observed that a small change $\Delta\delta$ in the frequency of O_1 results in a change of $15\Delta\delta$ in the frequency applied to the motor M_1 ; a frequency change of $\Delta\delta_1$ in oscillator O_2 , however, changes the motor frequency by the same amount only; hence the working oscillator is driven into synchronism 15 times as fast as is the standby unit. Actually, as is apparent, either oscillator may be used as the working oscillator.

It has been mentioned that, at the controlling station, a 6 kc/s signal is transmitted on every equipped pair; similarly at a controlled station the signal is transmitted on all equipped pairs and used for the control of carrier synchronisation at other stations, i.e. on all routes signals will be passing on all equipped pairs and for each direction of transmission and the selection of those actually used for control purposes is under the control of the terminal stations.

The working of the system is based upon all stations being synchronised at any one time to a particular terminal station which happens to possess a 1 kc/s supply of high accuracy. To overcome the effect of breakdowns high accuracy 1 kc/s oscillators are being provided at a number of points and at these stations the 4 kc/s oscillators can be synchronised by the 1 kc/s source; in the event of the breakdown of the master 1 kc/s the control would be taken over by the master at another station and the direction of control changed where necessary. The breakdown of isolated links is guarded against by the provision of control tone on all pairs and by the availability of alternative routings.

The advantages claimed for the synchronising scheme described are as follows:—

- (1) It is positive in action.
- (2) It is extremely flexible.
- (3) By reason of the mechanical inertia of the motor it is immune from the effects of flutter.
- (4) The controlled oscillators are not in forced oscillation, but are always oscillating at their natural frequency; hence, in the event of the failure of the pilot signal the oscillator does not immediately get out of step, but continues to oscillate at the correct frequency until either temperature or battery changes cause a change in the natural frequency of oscillation. As the oscillators are not in forced oscillation they can be made inherently stable. This stability of frequency even when control is lost, is a very important asset.

Carrier Generating Equipment.

Regarding the actual generation of the carrier and other necessary frequencies, it was decided that this should be effected by the "saturated coil" method. This method has been adequately described elsewhere⁵, but it is of interest to examine briefly the principle involved. The elements of the circuit concerned are shown in Fig. 7.

⁵Electrical Engineering, August, 1937.

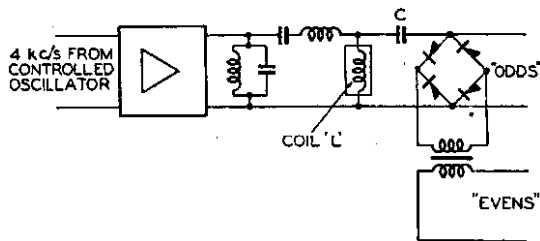

FIG. 7.—ELEMENTS OF CARRIER GENERATING CIRCUIT.

Current at 4 kc/s derived from the controlled oscillator is applied to the circuit of Fig. 7; the resonant circuit in shunt at the output of the amplifier and the series resonant circuit are employed to ensure that a relatively pure waveform is applied to the "saturated coil" L. This coil has a small core (usually of permalloy) and carries currents of such magnitude that over a large part of the applied cycle the core is saturated. It will be appreciated that the inductance of the coil is comparatively high while the core is not saturated, but falls to a very low value during saturation; i.e. it is non-linear. This non-linearity and the discharge path cause the waveform to be extremely "peaky." Fig. 8 shows the relative input

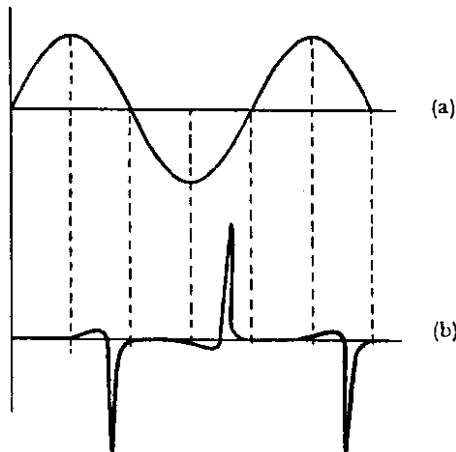

FIG. 8.—WAVEFORMS FOR CIRCUIT OF FIG. 7.
(a) Input, (b) ● output.

and output waveforms. The output waveform is rich in odd harmonics and it is found that the amplitudes of relatively high order harmonics vary but little, e.g. it might be found that the variation between the 17th and 27th harmonics of

4 kc/s was only 2 db. The necessary even harmonics are obtained by full-wave rectification.

Layout of System.

A block schematic diagram of a group end and its associated common equipment is shown in Fig. 3. The equipment comprises channel equipment, group frequency changing and combining equipment, G.D.F., H.F.R.D.F., line amplifiers, equaliser and frequency generating equipment.

The channel equipment, which comprises all the apparatus necessary to assemble 12 channels in the frequency range 60-108 kc/s and for the restoration of such a group of channels to individual voice frequency paths, is assembled upon two bay sides of standard type (10 ft. 6 in.). For the initial installations the group frequency changing and combining equipment (that which frequency changes 60-108 kc/s currents into the range 12-60 kc/s and *vice versa*, and also which can combine two 12-channel groups for transmission on one path) is accommodated on the channel bays. It is anticipated that it will be possible at a later date to rearrange the channel equipment so that it occupies one complete bay side only; when this has been accomplished the group frequency changing and combining equipment will be mounted upon separate bays—it is anticipated that four such equipments will be accommodated upon one bay side.

The two frames are of flexible type. When the H.F.R.D.F. was first introduced it was made of fixed size, and this was based upon consideration of the largest number of 12-circuit type cables it was anticipated would be employed in any one repeater station; however, the development of carrier transmission has been such that it was considered desirable to introduce frames which would be extensible in a manner similar to the standard R.D.F. Special problems were met in the design of the new frames and their associated wiring as crosstalk conditions are severe.

The main carrier frequency generating and associated synchronising equipment is mounted upon one double-sided bay; the output of this bay is sufficient to "drive" twelve channel equipments and also to supply power for synchronising tone for a corresponding number of pairs. This bay carries the standby as well as the "working" equipment. A second bay, which is provided only if and when required, is equipped with "worker" and "standby" amplifiers designed to supply carrier currents to 48 groups and the synchronising tone for a corresponding number of pairs.

Services in a Modern P.O. Building

R. S. PHILLIPS, A.M.I.E.E.

U.D.C. 621.311.23 621.315.67 621.395.2 621.876 697

The services provided in the North Eastern Regional Director's new office building are described, with particular reference to the under-floor ducts and removable skirting designed to give the maximum flexibility to the distribution systems.

Introduction.

THE services needed in a large office building are many and varied and careful thought must be given to their design and provision, both in the building planning stages and throughout the whole building progress if the installations are to give long and efficient service.

The modern methods which are employed in new Post Office buildings to provide the various services are well exemplified by the building forming the subject of this article. It is the new headquarters of the North-Eastern Region and houses the Regional Director and his staff on seven floors—exclusive of a small basement—the approximate area of each floor being 5,200 sq. ft.

Electricity Supply.

The Corporation's two incoming cables provide an electricity supply for the building at 200 V, 50 c/s, 2-phase on the 4-wire system, the cables being extended from the Corporation's cut-outs and meters to a low-tension ironclad switchboard installed in the basement. This switchboard consists of an angle iron framework equipped with a sheet steel busbar chamber and the main circuit-breakers and switch fuses.

One 400 A D.P. oil-immersed circuit-breaker of the draw-out pattern and fitted with two overload coils having oil time-lags, a no-volt release, two neutral links and two ammeters (one for each phase) controls the power supply 2-phase mains to the busbars. Two voltmeters, 0-250 V, indicate the busbar voltage on each phase. The single-phase and 2-phase power supplies from the busbars are protected by D.P. ironclad switch-fuses varying in capacity from 15 A to 100 A. As it is necessary for continuity of service to be maintained to the A.R.P. refuges, even if the main circuit-breaker is tripped, the power supply to the refuges is taken from the "live" side of the circuit-breaker. The 60 A switch fuse for this circuit is, therefore, the only safeguard and consequently fuses of high rupturing capacity have been provided.

Two circuit-breakers similar to that for the power supply, but of 300 A capacity each, control the two single-phase supplies to the main lighting distribution boards, the lighting loads being divided, as far as possible, equally between the two phases.

The total electricity consumption for the building is estimated at 80,000 units per annum for lighting and 55,000 units per annum for power.

Stand-by Generating Set.

In the event of a failure of the Corporation supply to the building, it is necessary for some alternative supply to be available to give continuity of service to the more important rooms. A satisfactory stand-by service was not available from the Corporation net-

work and an engine-driven alternator giving a supply at mains voltage was therefore installed on the sub-ground floor. To prevent vibration being transmitted through the building fabric it was necessary to isolate the engine from the floor. A pit 12 ft. 9 in. × 4 ft. 0 in. × 8 in. deep was excavated, in the bottom of which 2½ in. thick slabs of "Coresil" and compressed cork were laid, and on these materials the 14 in. thick concrete bed was floated, a 3 in. air space being provided between the sides of the bed and the floor. Finally, the fabricated baseplate was bolted to the concrete with Lewis bolts.

The prime mover of the set is a four-cylinder, overhead valve, 45 B.H.P., diesel oil engine, the governor of which is arranged for a maximum speed of 1,500 r.p.m. Electric starting equipment, including a 24 V storage battery and charging dynamo is provided, but hand starting is available and is facilitated by a half compression device. Fuel oil is pumped from the storage tank to the 30 gallon service tank by a semi-rotary hand pump. Circulating water cooling is effected by a Heenan and Froude cooler in which the water temperature is lowered by air, drawn from the refuges, being passed over the water grids.

The output side consists of an alternator giving

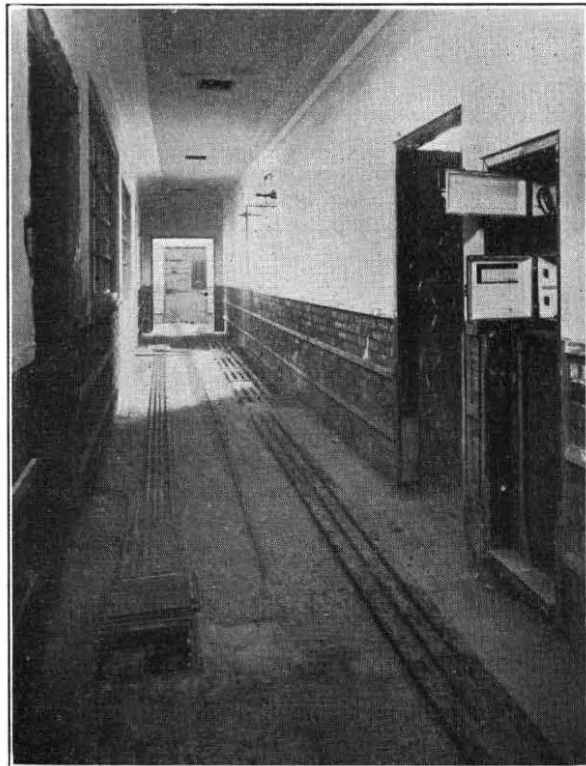

FIG. 1.—ENTRANCES TO MAIN VERTICAL DUCTS, ELECTRIC LIGHTING CONDUIT, AND FEEDS TO UNDERFLOOR DUCT SYSTEM.

15 kW at 200 V, 2-phase, 50 c/s directly coupled to the engine, a separate direct-coupled, shunt-wound field exciter being mounted on the same bedplate. The alternator voltage is controlled by a manually operated field exciter regulator, which, together with the ammeter, voltmeter and control gear, is mounted on a panel near the set. A 4-pole change-over switch enables the services to the important rooms to be fed from either the stand-by set or the main switchboard.

Cable Distribution.

Vertical distribution of power and lighting cables from the basement switchboard to the various floors is by two structural ducts, one at each end of the building and extending from the basement to the top floor. The clear internal dimensions of these ducts are 4 ft. wide by 10 in. deep and 2 ft. wide by 10 in. deep, entry to each duct at each floor being obtained by 6 ft. 6 in. doors, double for the larger duct, these doors harmonising with the surrounding woodwork. As it was desired to conceal not only as much cable as possible, but also the distribution boards, the main and sub-main lighting and power boards for each floor are accommodated in these ducts and are fixed opposite the duct doors. Entrances to these ducts are shown in Fig. 1. Phase "A" supplies lighting and single-phase power to one half of every floor, the main feeds of this phase being run in the larger of the two vertical ducts. The smaller of the two vertical ducts is utilised for the distribution of lighting and single-phase power from "B" phase of the other halves of the floors. Two-phase power supplies are fed direct to the ventilating plant-room and to the lift motor rooms via the vertical ducts.

The wiring from the floor distribution boards to the various fixed lighting points in the ceilings is by standard round conduit and V.I.R. cables, the conduits feeding out from the vertical ducts. Some of these conduit runs in a corridor are shown on the left in Fig. 1. All conduits are concealed in the floor filling, and those in any particular floor will, of course, serve the lighting points for the floor below. A fixed conduit system such as this is not suitable for distributing the wiring to table lamps and small power points, the positions of which may require alteration from time to time, and these cables are therefore run in an underfloor duct system—a much more flexible arrangement. In addition to these underfloor ducts, steel skirting has been fitted round the walls of each room to accommodate the cabling for services required on or near the walls. The feeds from the main vertical ducts to the underfloor ducting and skirting are plain rectangular steel ducts with no intermediate outlets, these ducts being laid mainly in the corridors as shown on the right-hand side in Fig. 1.

Distribution of telephone cables from the P.M.B.X. on the second floor is on somewhat similar lines to that for the power services. A third structural duct situated at the front end of the building, extending from the basement to the top floor and passing through the P.M.B.X. room, provides facilities for running the incoming main telephone cable and for wiring from the board to the various floors. This vertical duct is 22 in. wide and 17 in. deep and has an entry at each floor by a 6 ft. 6 in. door similar to those provided for the power ducts. The larger of the two E, L and P ducts at the rear of the building is also used for the vertical distribution of telephone and other low voltage cables to that portion of the building. As with the power distribution boards, the main telephone distribution boards are fitted in one or other of these two ducts. The cables to the sub-distribution boards—the latter concealed in the walls of the rooms as shown in Fig. 2—and

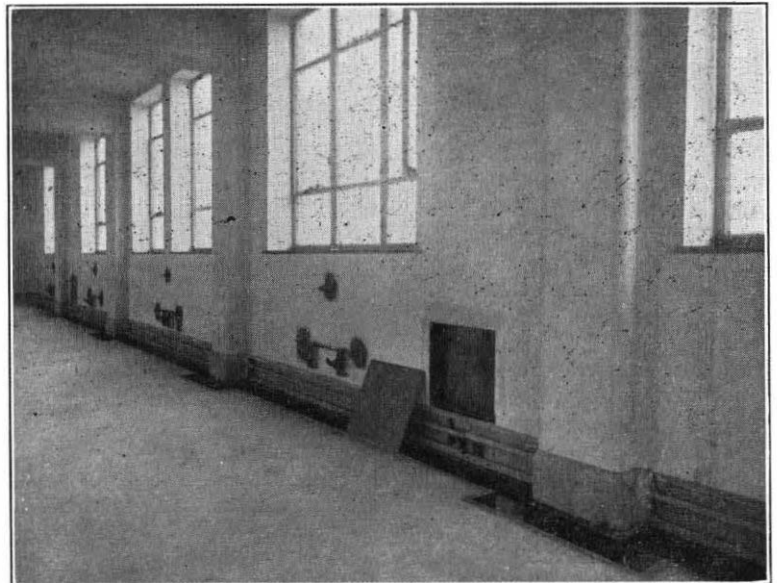

FIG. 2.—STEEL SKIRTING, HEATING PIPE TRENCH AND CONCEALED TELEPHONE SUB-DISTRIBUTION BOARD.

the wires from these boards to the tables, are accommodated in either the underfloor duct system or the steel skirting.

Underfloor Duct System.—Of the ducts available the two smaller sizes, $2\frac{1}{2}$ in. \times $1\frac{1}{2}$ in. and $2\frac{1}{2}$ in. \times $1\frac{1}{2}$ in. were thought to be most suitable for this building, and a triple system was considered necessary. Each run consists of three separate ducts laid parallel to each other and all passing through the same triple junction boxes. These boxes incorporate special steel separators which prevent contact in the box, between the cables from any duct and those from either of the other two ducts. If desired, three ducts can be fed into each of the four sides of the box, as shown in Fig. 3. Two ducts of each set of three are utilised for the cabling for telephones, signalling bells, clocks and other low voltage services, the third duct accommodating the wiring for table lamps and power

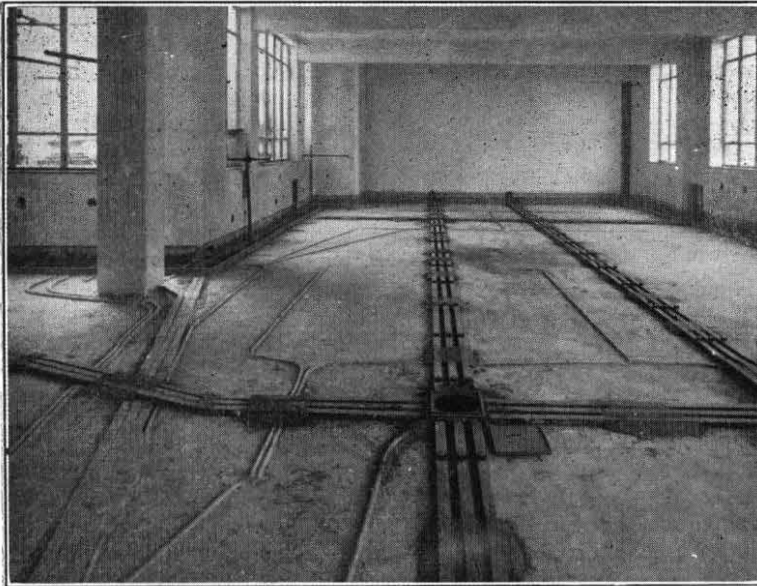

FIG. 3.—TRIPLE RECTANGULAR UNDERFLOOR DUCTS AND CIRCULAR LIGHTING CONDUITS FOR FLOOR BELOW.

sockets at mains voltage. The main feature of the system is that outlets are provided at intervals of 3 ft. along the length of each of the three ducts and, with a properly planned layout of ducts, a table can be placed almost anywhere in a room and still be near one of the available sets of outlets. These circular outlets, screwed internally, are fitted on the duct and extend above it to a height of $\frac{3}{4}$ in. A brass marker with a centre locating screw which is flush with the linoleum, is screwed into each outlet that

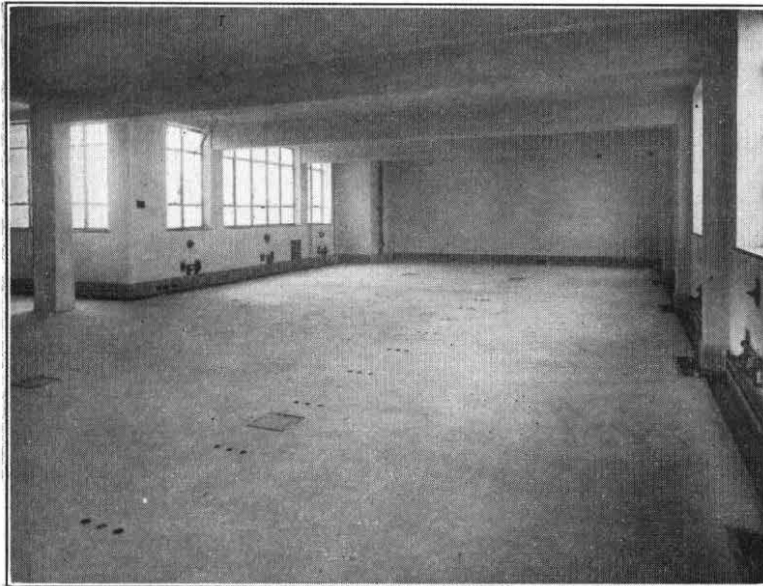

FIG. 4.—OUTLETS FROM UNDERFLOOR DUCT SYSTEM AND METAL SKIRTING AROUND WALLS.

is not used for wiring purposes—see Fig. 4. When the outlets are in use, the markers are removed and replaced by sockets and plugs or screwed connectors for table lamps or telephones respectively.

The cost of providing and installing underfloor ducts and the necessary accessories is high compared with the more usual methods of cabling, but it is considered that the resulting advantages in a building of this type outweigh the high initial cost. To employ these ducts in a building it is necessary to ensure that the architect is able to provide sufficient floor filling, not only to conceal the ducts, but also to enable the outlet markers and the junction box covers to be level with the linoleum or other floor covering. In this building a minimum floor filling of 3 in. was used in every room. Close co-operation must be maintained with the Clerk of Works in order that the ducts will be ready for laying, and for filling in, at the required times. Exact measurements of the final floor levels and coverings must be available during duct laying operations and care must be exercised in levelling the runs, if a neat final appearance is to be obtained. Fig. 4 shows covered duct runs, the photograph being taken before the linoleum was laid.

Steel Skirting.—Although the underfloor duct system can be arranged to provide services to tables near the walls as well as to those in the centre of rooms, it was considered that economy would result by dispensing with ducts near walls and instead, fitting a hollow steel skirting around the walls—see Fig. 2. This combination of ducts and skirting affords excellent facilities for cabling to any part of a room, the former being used for positions away from walls and the latter for those near to walls, although in some positions the use of either is possible. Further, the frequent linking up of ducts and skirting results in a very flexible distribution network.

It is necessary with the skirting, as with the ducts, to provide two separate spaces, one for the E.L. and P. cables and the other for the low-voltage telephone and miscellaneous wiring, and skirting was therefore designed with a shelf which gave approximate cabling areas of $2\frac{3}{4}$ in. \times $1\frac{1}{2}$ in. and $5\frac{1}{4}$ in. \times $1\frac{1}{2}$ in. for the E.L. and P. and telephone cables respectively.

This latter space is reduced to $4\frac{1}{2}$ in. \times $1\frac{1}{2}$ in., however, where the skirting is against outside walls and has to be fitted above the heating pipe trench covers. The constructions of both types, which were made from No. 22 gauge steel, are shown in Fig. 5. Cabling is facilitated by making the front removable in lengths of 3 ft., between each of which is fitted a short 4 in. piece. These short lengths may be used for sockets or any other form of outlet and they then, of

course, become fixtures.

Lighting.

Most of the general lighting in the building is provided by the Post Office standard totally-

enclosed pendant fittings arranged to give the Treasury illumination standard of 5 ft. candles. The general lighting in the drawing office, however, is obtained from circular steel reflectors suspended

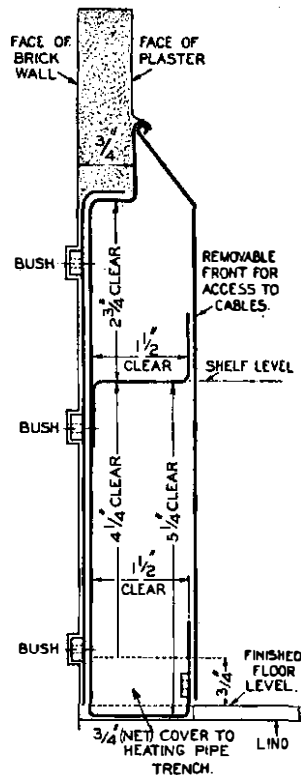

FIG. 5.
METAL SKIRTING DETAILS.

lighting is supplemented by individual table fittings in the drawing office and the rooms occupied by the Regional Director and his principal assistants.

During the preparation of the lighting scheme much thought was given to the selection of the lighting positions in relation to the structural beams and partition walls. Endeavour was made to obtain layouts which would result in the fittings being placed at uniform distances from the ceiling beams, these layouts being also independent of the positions of partition walls. The result was a scheme which should require the minimum of alteration to fitting positions or disturbance of concealed conduit, if it is found necessary at some future date to alter the sizes of certain rooms by removing or erecting partition walls. For the same reason, care was taken to ensure, as far as possible, that switches were kept off partition walls.

Heating.

The cubic content of the building requiring heating is 370,000 cubic ft. and this necessitates the generation of 1,049,000 B.T.U.s per hour, which is well within the capacity of the two "Robin Hood Major" boilers installed in the basement. Each of these boilers is capable of 792,000 B.T.U.s per hour, and they supply the hot water for heating the building

on a low-pressure forced circulation system. Most of the radiators employed are of the ordinary cast iron pattern, but as the walls of some of the principal rooms are panelled, convector type radiators, concealed behind the panelling, were installed, the air circulation being obtained by bronze grilles. All heating pipes are concealed either in vertical ducts or in floor trenches, an example of the latter being shown in Fig. 2.

Auxiliary electric heating is provided in the principal rooms, and consists of 2 kW radiators with a special surround and mounted flush with the wall panelling.

Mechanical Ventilation.

The conference room on the fifth floor is fitted with double windows to preclude the possibility of external noise interfering with important conferences. The need for artificial ventilation at once became apparent and it was decided to install a plenum system. A separate fan-room erected on the roof, houses a standard plenum unit consisting of a motor-driven fan and filter, together with a 9 kW electric air-heater and the associated control gear. "On" and "Off" remote control buttons, fitted in the conference room, control the ventilating unit, similar adjacent buttons controlling the heater. These buttons are duplicated in the fan-room for maintenance purposes. The switching arrangements are interlocked so that it is not possible for the heater to be on without the fan running, although the latter can be switched independently of the heater. An adjustable thermostat fitted in the ductwork governs the temperature of the air to the room.

The sub-ground floor is divided into rooms used as the staff air-raid refuges and other rooms in which work will be carried on regardless of local air raids. Ventilating plant is essential for both of these types of accommodation as the possibility of bombing and gas attacks prevents the use of natural ventilation. Fig. 6 shows the layout of the ventilating plant and ductwork, the latter being represented by single lines for clearness.

Air raid refuges 1 and 2 are ventilated by plant "A," which is designed to supply 150 cu. ft. of air per person per hour, the air being drawn in through a high level inlet duct and "A" filters by centrifugal fan "A" of rated capacity 2,500 cu. ft. per minute. From this fan the air is blown through the connecting ducts and enters the refuges by conical nozzles in the ductwork. As the refuges are sealed against the entry of gas, a separate exhaust system for each refuge is necessary and this is provided by fan C1, also of capacity 2,500 cu. ft. per minute. The outlet ducts from the refuges terminate at the fan and are extended to the high level outlet.

One of the main differences between the air raid refuge plant described above and the working space ("W.S.") refuge plant is that the latter is designed to supply 1,000 cu. ft. of air per person per hour instead of 150. Air is drawn in through the high level inlet duct, and passes from "B" filters to either fan B1 or B2 (one is a stand-by), each of capacity

800 cubic ft. per minute. From here the air is blown through a 9 kW electric heater controlled by a thermostat which ensures the temperature of the air passing to the refuges being 60°F. Fan C2 constitutes the exhaust system for these refuges, the fan being rated at 800 cubic ft. per minute. Unlike the air raid refuge plants, fans B1 or B2 and C2 are running continuously and therefore a constant and known amount of air is being exhausted from the "W.S." refuges. It was thus possible to utilise this air for cooling the diesel engine circulating water. The exhaust ducts from the refuges terminate in a header fixed to a Heenan and Froude water cooler through which the diesel engine circulating water is pumped. After traversing the cooler and thus lowering the temperature of the water, the outgoing air, now practically saturated, is exhausted by centrifugal fan C2 to the main outlet duct.

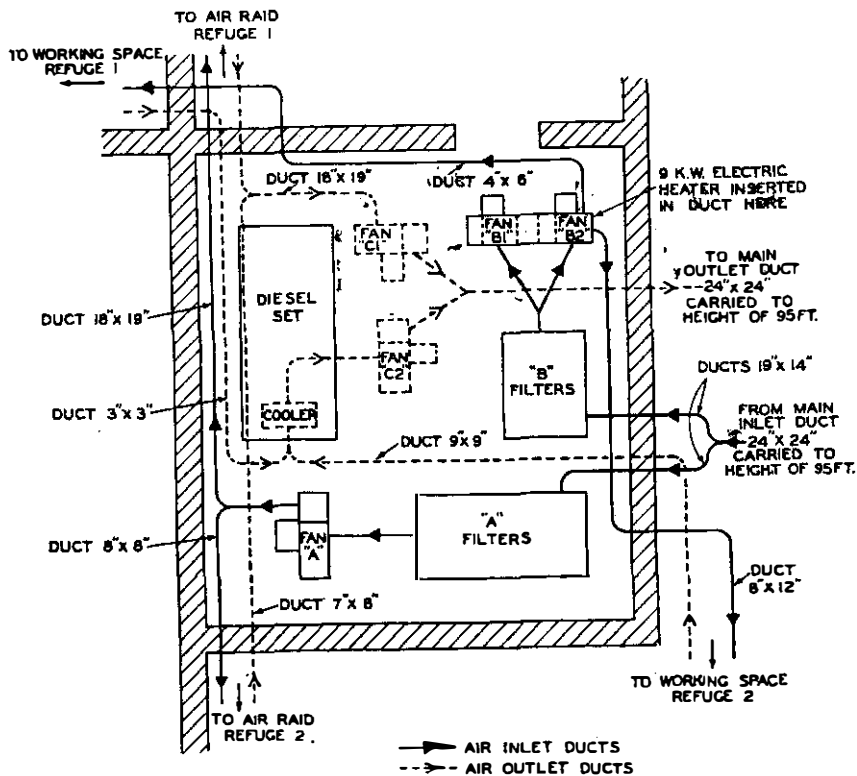

FIG. 6.—MAIN VENTILATING PLANT.

Lifts.

The building is adequately served by three electric lifts: one passenger, one goods and one service lift. The passenger and goods lifts serve all floors—sub-ground to fifth—except the small basement, and occupy two adjacent wells at the front end of the building, but the service lift operates only between the sub-ground and ground floors.

(a) *Passenger (No. 1).*—A motor room erected on the roof houses the motors and control gear for both the passenger and goods lifts, the layout of the plant being shown in Fig. 7. As the passenger lift travel is 70 ft., this justified a maximum speed of 350 ft. per minute and consequently the provision of a lifting motor operated on the variable voltage principle. The lift motor obtains its supply from a D.C. generator which is directly coupled to a 2-phase induction motor driven from the mains, and to a D.C. exciter. In this system lift speed variation is obtained by altering the strength of the generator field and by this means there are no sudden speed changes during acceleration or retardation. The exciter supplies current to the generator field, lifting motor field, electromagnetic brake and the electromagnets of the control gear. A standard Vee-sheave drive is used, the four ropes passing direct from the car to the counterweight without employing intermediate idle pulleys. Worm and worm wheel reduction gearing of the over-type (worm above the wheel) is installed between the lift motor and the driving sheave, the worm being of steel and the wheel of cast iron with a renewable phosphor-bronze rim. The electromagnetic brake operates on the coupling between the motor and gear-box. The

car has a capacity of 15 cwts., the two-leaf doors being operated automatically by a small electric motor fitted on the car roof. Landing doors, which open to the main halls at each floor, are also automatically opened and closed, this being effected by the coupling of the car door to the appropriate landing door when the lift reaches a landing. Dual control (either automatic push-button or car switch) is employed, the change being effected by a key switch in the car. A landing call indicator and buzzer are fitted in the car for use when on car switch control. The motor generator control incorporates a shut-down device whereby the set automatically shuts down if the lift is not used for a predetermined period, this cut-off being adjustable up to a maximum of 10 minutes. Operation of the car-switch or a landing call button restarts the set. An illuminated landing position and direction indicator is installed on each floor. Safety gear of the gradual wedge clamp type is fitted under the car and under the counterweight and is operated by a rope attached to a centrifugal governor in the motor room. This governor is driven by a rope secured to the car and a governor switch opens, cuts off the controller, and applies the brake if the maximum car speed is exceeded by 10 per cent., while the governor will operate the safety gear if the speed increases still further to 20 per cent. above the maximum speed. Oil buffers are installed in the bottom of the well, under the car and under the counterweight, and lessen the impact if the car overtravels the terminal floors and opens the emergency limit switches fitted in the well. The controller is equipped with the usual safety and

non-interference devices which prevent interference from landings when the car is in motion.

(b) *Goods (No. 2).*—This lift has a maximum speed of 200 ft. per minute and the drive is by a two-speed

(c) *Service (No. 3).*—This is a small lift of 1 cwt. capacity intended primarily to convey files of papers between the registry and the records room and is driven by a 2-phase slip-ring induction motor which, operating through worm gearing, gives a cage speed of 50 ft. per minute. Vertical shutters are installed on the cage and at each loading level, the distance between the levels, i.e. the lift travel, being 11 ft. The control is semi-automatic push-button and both cage safety gear of the instantaneous cam type and volute spring buffers are fitted.

Telephones.

The main telephone requirements are provided by exchange lines from the public auto-exchange to the various instruments via a P.M.B.X. installed on the second floor of the building. Interception facilities have been incorporated whereby calls to the instruments of certain officers occupying single rooms may be answered in their absence.

A 2 + 10 house exchange system enables the Regional Director to communicate directly with his principal assistants. In addition, separate 2 + 10 systems are installed for each of the five branches so that the Controller of each can communicate directly with any one of a selected group of his principal officers. These branch systems also provide means of direct communication between the principal officers in any particular branch.

Clocks.

Post Office standard type ½-minute impulse clocks (No. 58A) are installed throughout the building, with the exceptions of the Regional Director's and Deputy Regional Director's rooms in which specially designed dials have been provided to harmonise with the panelling.

Staff Signalling Systems.

A lamp indicator system is provided for the use of the principal officers so that each can give an external indication of whether he is "engaged" or "free." This consists of two small low voltage lamps, one red and one green fitted outside and above each door, the former indicating "engaged" and the latter "free." Duplicate lamps are installed above each door on the inside thus enabling the occupants of the rooms to see the nature of the outside indications. Operation or cancellation is controlled by a push button tablet fitted on each of the officers' tables.

The usual messenger and typist call services are available in each office, the call buttons being on a table tablet and the indicators in the messengers' and typists' rooms respectively.

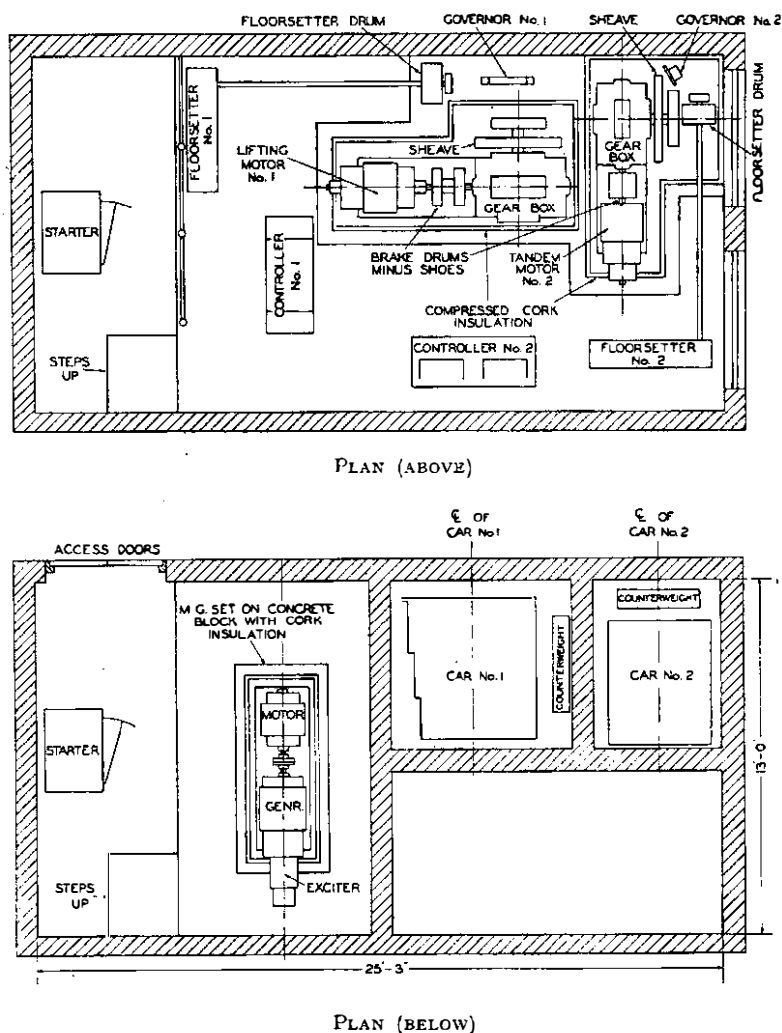

FIG. 7.—LAYOUT OF LIFT MOTOR ROOM.

tandem motor with over-type worm gearing and Vee-sheave. The motor comprises a high speed slip-ring section and a low-speed squirrel-cage section built in one unit, the former being employed during starting and running at maximum speed, and the latter when the lift is travelling at slow speed during the approach to a landing. The car has a capacity of 10 cwts. and is fitted with a standard collapsible gate but, unlike the passenger lift, the landing doors and car gate are manually operated. Control is by a fully automatic push-button system. Instantaneous cam type safety gear is fitted under the car and counterweight and is operated by an overspeed governor in a similar manner to that on the passenger lift. The buffers for this lift are of the volute spring pattern, two being installed in the well under the car and two under the counterweight.

The Phase Cyclometer

U.D.C. 621.317.772

H. T. MITCHELL, A.M.I.E.E., and
T. KILVINGTON, B.Sc.(Eng.)

The rotary phasemeter used for the measurement of changes of insertion phase shift at radio frequencies is not a suitable instrument when the phase shift exceeds 360° . This article describes a cyclometer which may be used in conjunction with the phasemeter to record the number of 360° phase-cycles between two frequencies, to which the phasemeter reading must be added, thus increasing the range of the instrument indefinitely.

Introduction.

THE necessity for phase measuring apparatus in the development of television equipment has already been pointed out in a recent article¹ which described a method of measurement developed in the Post Office laboratories. The method uses a rotary phasemeter to indicate directly insertion phase shift. Phase shift indications by this method are obviously limited to values not exceeding 360° and if the phase shift is actually greater than 360° , e.g. $360N^\circ + \phi$ (where N is an integer), the value indicated by the phasemeter will be ϕ and no account will be taken of the $360N^\circ$.

In practice this method works well for measurements on repeaters, equalisers, filters and the like in which the rate of change of phase with frequency is small, but difficulties are encountered when measurements are attempted on wide band cable circuits with lengths of more than a few hundred yards. To quote a concrete example, experimental measurements on a wide band coaxial cable loop circuit of about 18 miles length were carried out, using the rotary phasemeter equipment, and it was found that the frequency steps provided at intervals of 100 kc/s were inadequate for determining the change of phase shift. Using a separate continuously variable oscillator, it was found by making measurements at very small frequency intervals that, for a frequency change of 100 kc/s, there were as many as 10 or 11 "phase cycles." That is to say, that if the phase shift at the lower frequency f_1 is $360N_1^\circ + \phi_1$ and that at the higher frequency f_2 is $360N_2^\circ + \phi_2$, then $N_2 - N_1 = 10$ or 11 when $f_2 - f_1 = 100$ kc/s. Spot measurements with the rotary phasemeter used in the normal manner at 100 kc/s intervals would have given only the values of ϕ_1 and ϕ_2 . Over the complete range for this particular cable circuit (0.2 to 3.2 Mc/s) there were more than 300 phase cycles and it is obvious that a complete measurement would be a very tedious process. On longer lengths of say 200 miles the measurement would be quite impracticable, for the number of phase cycles would exceed 3000 over the same frequency range.

An alternative method of determining the value of $N_2 - N_1$ is by computation from the primary

constants of the cable. This method is only applicable to relatively short lengths of cable and assumes that the cable circuit has a smooth phase/frequency characteristic.

A method was therefore sought of determining the unknown quantity $N_2 - N_1$ by some means other than that of making accurate phase measurements at small frequency intervals or computations and thus of simplifying the measurement of very large phase differences. For this purpose the "phase cyclometer" was evolved. Briefly, this instrument counts the number of complete phase-cycles between two given frequencies, the result being shown on a counter of the telephone subscriber's call-meter type.

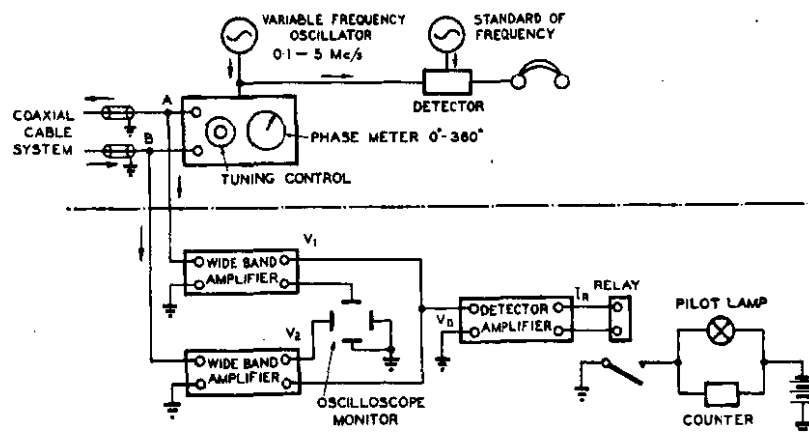

FIG. 1.—MEASUREMENT OF PHASE CHANGES GREATER THAN 360° .

Description of the Apparatus.

At the top of Fig. 1 is shown the normal phase measuring equipment using a continuously variable frequency oscillator in place of the crystal oscillator normally used. At some given frequency the voltage received from the cable loop will be exactly out of phase with the voltage fed into the loop. If the frequency is slowly increased until the received voltage is again exactly out of phase with that sent, then the frequency change has caused one complete phase cycle or one complete revolution of the phase-meter needle, assuming the equipment has been held in tune throughout. In the phase cyclometer, which is shown in the lower part of Fig. 1, the sent and received voltages are added vectorially after they have been amplified to approximately the same level.

¹P.O.E.E.J., Vol. 33, page 162.

The resultant is rectified and the rectified voltage used to control a relay which in turn operates a counter and pilot lamp in parallel. When the frequency is such that the sent and received voltages are out of phase, giving rise to a very small resultant, the circuit is so arranged that the relay is operated, and when the frequency is such that they are in phase, giving a large resultant, the relay is released.

It will be seen, therefore, that if the frequency is slowly increased from f_1 to f_2 , the counter will record the number of frequencies at which the sent and

operating point of the relay may be adjusted. This relay controls the counter and pilot lamp in parallel, the pilot lamp indicating whether the counter is operated or not. This information is important as will be explained later.

The monitoring signals are fed to the two pairs of plates on the oscilloscope. Besides enabling the two voltages V_1 and V_2 to be made approximately equal in amplitude, the shape of the figure obtained provides a rough check on the phase difference between them. Typical figures for various phase

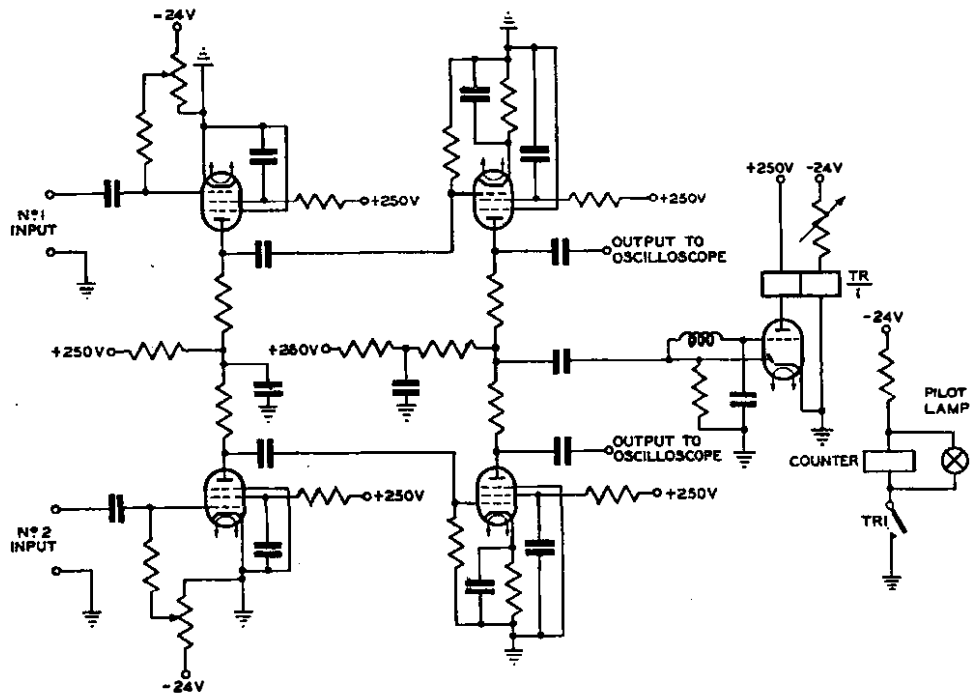

FIG. 2.—CIRCUIT DIAGRAM OF PHASE CYCLOMETER.

received voltages are out of phase. In other words, it will measure the number of phase cycles between f_1 and f_2 . The apparatus will now be described in more detail.

The outbreak of war has delayed the construction of the apparatus in its final form but Fig. 2 shows the circuit diagram of the experimental set-up which was found to work satisfactorily. The voltage fed to the cable loop and that received from it, are fed to the grids of two variable-mu valves. Bias adjustments on these valves enable the signal levels to be suitably adjusted and made approximately equal. A further fixed-gain amplifying stage is provided for each signal and this supplies a voltage at a level sufficiently high to feed the deflecting plates of a monitoring oscilloscope. In addition, a small part of the anode load of these valves is made common to both valves so that in this portion of the load the two signals are added vectorially. This signal, V_D , is passed to a diode-triode detector-amplifier, the anode of the triode being fed through one coil of a telegraph relay. The bias winding of the relay is provided with a pre-set bias current so that the

differences and equal amplitudes are shown in Fig. 3. It may be noted that since part of the anode load is common to both the amplifying valves, the figures will be somewhat distorted; the effect, however, is small in practice.

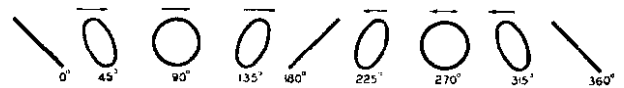

FIG. 3.—FIGURES OBTAINED ON MONITORING OSCILLOSCOPE FOR VARIOUS PHASE DIFFERENCES.

If V_1 is the portion of the output voltage from one amplifier fed to the diode circuit. V_2 is that from the other and ϕ is the phase angle between them, then the resultant voltage V_D applied to the rectifier is:—

$$(V_1^2 + V_2^2 + 2V_1 V_2 \cos \phi)^{\frac{1}{2}}$$

A family of curves showing the relation between V_D/V_2 and ϕ for various values of V_1/V_2 is shown in Fig. 4. It will be seen that the curves for the different ratios of V_1/V_2 cross at approximately 135° and 225° and use is made of this fact by arranging that the

relay is operated between these values, so that the value of V_1/V_2 is not critical.

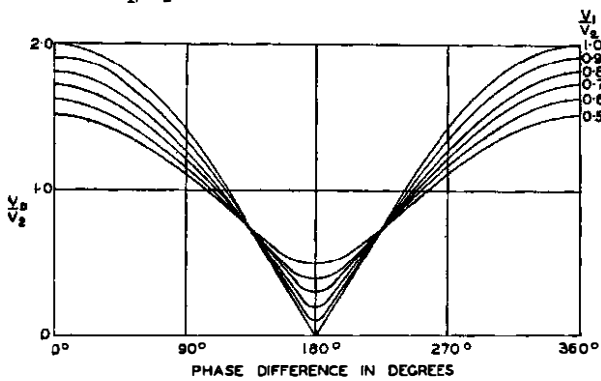

FIG. 4.—VARIATION OF V_D/V_2 .

Assuming that the detector-amplifier is linear, graphs of the corresponding current through the relay winding in the anode circuit of the amplifier for different phase angles will be of the general shape shown in Fig. 5. The current through the bias winding of the relay is then adjusted so that the relay

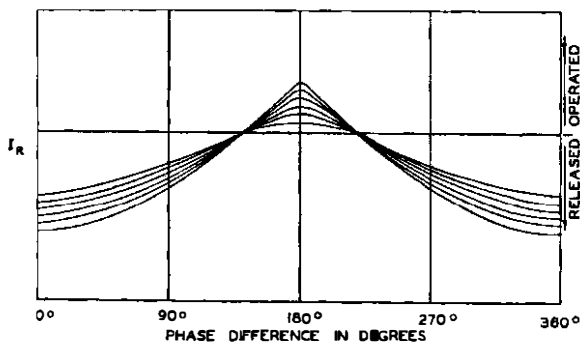

FIG. 5.—VARIATION OF RELAY CURRENT.

operates for values of ϕ between 135° and 225° . With the particular counter used, the figure is registered when the counter releases so that it is necessary to know whether the counter is operated or not when measuring angles in the neighbourhood of 225° ; this is indicated by the pilot lamp.

Method of Operation.

The method of operation is best understood by considering an actual example. Suppose that the rotary phasemeter measurement gives readings of 35.5° and 179.3° at frequencies f_1 and f_2 respectively,

f_1 being the lower frequency. Then it is known that the insertion phase shift at f_1 is $360N_1^\circ + 35.5^\circ$ and at f_2 is $360N_2^\circ + 179.3^\circ$, where N_1 and N_2 are integers. It is now desired to find the value of $N_2 - N_1$.

The crystal oscillator is set to the frequency f_1 and the variable frequency oscillator is set to the same frequency by listening to the audible beat note between the two. The voltages V_1 and V_2 are set to suitable values judging by the deflections on the monitoring tube. The value of 35.5° is roughly checked by the pattern on the screen and the counter reading is noted. Suppose it is 5765 and the counter is not operated (i.e. pilot light extinguished). The crystal oscillator is then set to the upper frequency f_2 and the frequency of the variable oscillator is increased at a steady rate until it reaches the value f_2 , again judged by the audible beat note between the two oscillators. The rate at which this change can be made is limited only by the speed at which the counter will operate, though care must be taken not to overshoot the frequency f_2 . At frequency f_2 the value of 179.3° is roughly checked by the pattern on the screen and the counter reading is again noted. Suppose it is now 5776 with the counter operated (i.e. pilot lamp alight).

$$\text{Then } N_2 - N_1 = 5776 - 5765 = 11.$$

If the phase angle at f_2 had been 279.3° instead of 179.3° , then the counter would have registered once more on passing through the 225° phase angle although another phase cycle would not have been completed. This fact must be remembered when dealing with phase angles between 225° and 360° ; it presents no difficulty in practice.

It should be pointed out that although in Fig. 1, the crystal oscillator is shown merely as a frequency standard, this applies only when determining the various values of $N_2 - N_1$; the crystal oscillator would be used for determining the values of ϕ at the specific frequencies at 100 kc/s intervals.

Conclusions.

The phase cyclometer forms a useful accessory to the rotary phasemeter measuring equipment—an accessory which is almost essential in wideband cable measurements where the length of cable exceeds a few hundred yards. For relatively short lengths of cable the work of the cyclometer may be covered by computation of the phase/frequency characteristic of the cable circuit, but even in this case the cyclometer method has the advantage, and gives the satisfaction, of being an absolute measurement independent of the assumption that the phase/frequency characteristic is smooth.

Principles of Design of Smoothing Chokes

U.D.C. 621.314.61 : 621.318.42

R. O. CARTER, M.Sc., A.M.I.E.E., and
D. L. RICHARDS, B.Sc.(Eng.)

The article describes a method of design of choke coils having laminated cores with air gaps, as applied particularly to the smoothing filters used in floating battery power supply systems. The fundamental properties of core materials under combined steady and alternating magnetisation are briefly described. Curves and formulae for 4 per cent. silicon steel are derived which enable the most suitable design of coil to be obtained for any particular performance requirements.

Introduction.

ON account of the wide application of silicon steel alloys to electrical machinery and transformers, the properties of these materials when subjected to purely alternating magnetic forces were early investigated, and the information necessary for most design purposes is now readily available. The condition of incremental magnetisation, that is, of an alternating magnetising force superimposed on a steady or polarising magnetising force, is of comparatively infrequent occurrence in apparatus associated with the supply and utilisation of electric power. It is, perhaps, for this reason that the behaviour of silicon steels under this condition of magnetisation has only recently been studied in detail.

The British Standards Institution (B.S.I.) has prepared a specification (Reference *a*) for magnetic materials to be used under combined D.C. and A.C. magnetisation; it is to be hoped that its publication will lead to uniformity in the methods of measurement and manner of presentation of technical data, and in the method of acceptance testing of materials.

Transformers and chokes carrying both alternating and direct current occur frequently in telecommunication circuits. With the development of floating battery power supply systems in telephone exchanges and repeater stations, there is a considerable demand for smoothing chokes. In some of the larger stations each choke may weigh as much as a ton and the cost of the complete smoothing filter may be comparable with that of the associated motor-generator set.

There is therefore an increasing demand for information on the relevant properties of suitable core materials and for a scientific method of design of chokes for any particular requirements. The design method about to be described is based on experimental work on silicon steels, since this material is invariably used for the cores of large chokes. All the curves given are typical characteristics for 4 per cent. silicon steel, but the same principles apply to other grades and probably also to other ferromagnetic materials.

A brief description of incremental magnetic properties and of the recommendations of the B.S.I. specification will first be given.

Fundamental Considerations.

Fig. 1 shows the general shape of a typical B-H curve for a ferromagnetic material. This curve gives the variation of the induction or flux density (B) as the applied magnetising force (H) is increased steadily from zero, the specimen being initially unmagnetised. The corresponding curve of permeability μ ($=B/H$) is also shown. If, after reaching

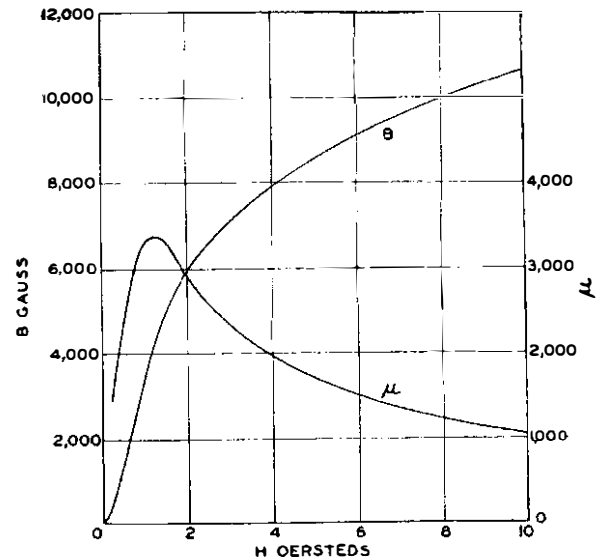

FIG. 1.—TYPICAL MAGNETISATION AND PERMEABILITY CURVES.

a certain maximum value, the magnetising force is then decreased to zero and increased to the same maximum value in the opposite direction, the induction will not follow the same curve. However, if the value of H is varied smoothly between a maximum positive and the same maximum negative value a number of times, the material will settle down to a cyclic state, and will follow one of the well-known hysteresis loops shown in Fig. 2, the size

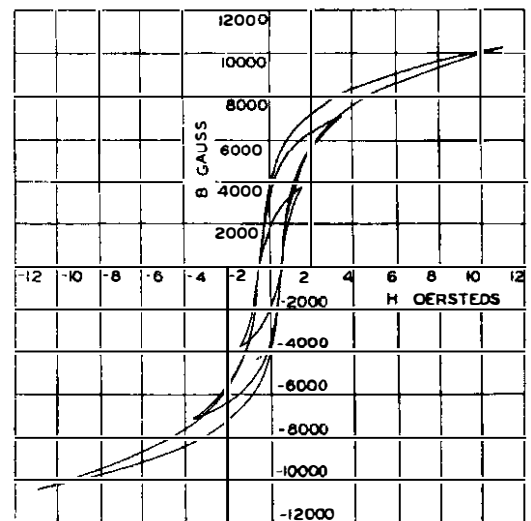

FIG. 2.—HYSTERESIS LOOPS FOR PURELY ALTERNATING MAGNETISATION.

of the loop depending on the material and on the maximum value of H . This represents the behaviour of the material when subjected to purely alternating magnetisation of low frequency.

Suppose now that a steady or polarising magnetising force H_p is applied to an initially unmagnetised specimen, bringing it to the operating point P in Fig. 3. If a slowly alternating magnetising force (not necessarily sinusoidal) is superimposed on the force H_p , so that the value of H varies smoothly from $H_p - \hat{H}_\Delta$ to $H_p + \hat{H}_\Delta$, the material will settle down after a large number of reversals, to a cyclic state represented by the loop SR . It will be observed

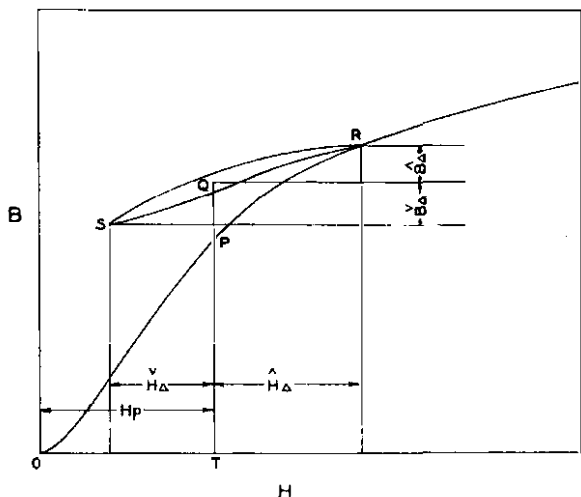

FIG. 3.—HYSTERESIS LOOP FOR COMBINED POLARISING AND ALTERNATING MAGNETISATION.

that the mean value of the induction (i.e. the polarising induction B_p) is increased from PT to QT when the alternating magnetising force is applied. The mean slope of the loop SR will be an approximate measure of the permeability (called the incremental permeability) of the material to the superimposed alternating magnetising force. A more precise definition of this quantity will be given later. The ratio (QT/OT) of the polarising induction to the polarising magnetising force will be called the polarisation permeability, μ_p . It is evident that when the amplitude of the alternating magnetising force is zero, the polarisation permeability ($=PT/OT$) is identical with the ordinary D.C. permeability μ of the material. From Fig. 3 it will be seen that the incremental permeability is less than either μ_p or μ .

It should also be noted that even when the amplitude of the alternating magnetising force is very small, the incremental permeability does not, as is commonly supposed, approach the slope of the magnetisation curve, but is always much less than this.

The incremental loop of Fig. 3 is unsymmetrical. If the incremental magnetising force (H_Δ) is sinusoidal, the incremental induction (B_Δ) will contain harmonics, and the positive and negative peak values, \hat{B}_Δ and $-\hat{B}_\Delta$, of the incremental induction will not be equal. Similarly if the conditions of test are such that B_Δ is sinusoidal, H_Δ will contain harmonics. Even if the R.M.S. values of either H_Δ

or B_Δ are the same under the two conditions, slightly different loops will be described and different values of incremental permeability will apply.

To minimise the complication arising from these effects, the B.S.I. specification makes the following recommendations:—

- (1) That the conditions of test shall be such that B_Δ is maintained sinusoidal as closely as possible.
- (2) That for any given value of H_p , the values of H_Δ or B_Δ used shall be restricted to a range in which serious distortion of the waveform of H_Δ does not occur.
(For silicon steel, the percentage modulation of H , i.e., $\frac{\hat{H}_\Delta}{H_p} \times 100$ should not exceed 50 per cent.)¹
- (3) That when some distortion does occur, the harmonics in H_Δ shall be disregarded. The fundamental component of H_Δ will not be in phase with B_Δ . The incremental permeability shall be defined as a vector quantity, μ_Δ/θ , the magnitude being equal to the ratio of B_Δ (which is sinusoidal) to the fundamental component of H_Δ , and the angle equal to the phase angle between these quantities.

In what follows, B_Δ will be assumed sinusoidal. \hat{B}_Δ will denote the peak value of B_Δ , and \hat{H}_Δ will denote the peak value of the fundamental component of H_Δ .

The foregoing description is merely a summary of the phenomena associated with the incremental magnetisation of ferromagnetic materials in general

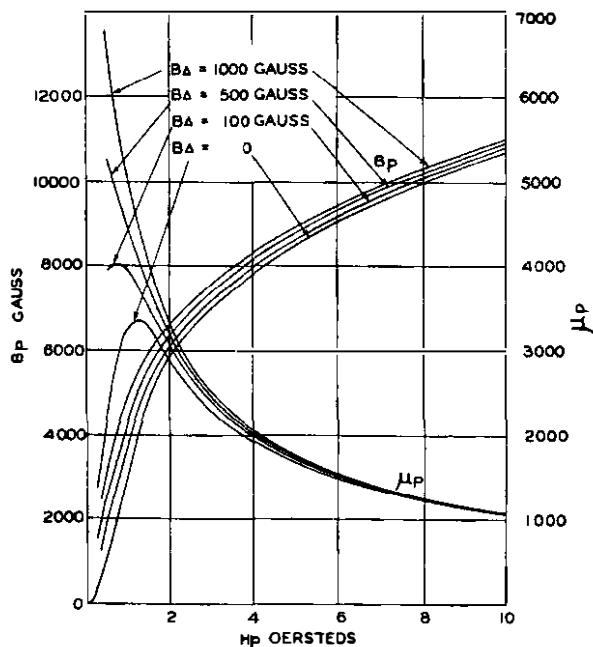

FIG. 4.—MAGNETISATION AND PERMEABILITY CURVES WITH SUPERPOSED ALTERNATING MAGNETISATION.

¹From Fig. 3 it will be evident that the percentage modulation of B , $\frac{\hat{B}_\Delta}{B_p} \times 100$, is always less than the percentage modulation of H .

and of silicon steels in particular. A more detailed treatment of the subject is given in References (a) to (i) in the list at the end of the article.

Experimental data required.

As already explained, the value of the polarising induction (B_p) for a given value of polarising magnetising force (H_p) is altered when an alternating magnetising force (H_Δ) is superimposed, i.e., B_p is a function not only of H_p but also of H_Δ or alternatively of B_Δ . In practice B_Δ is the more convenient parameter.

A family of magnetisation curves (B_p against H_p) for various values of B_Δ can be derived experimentally for the material under consideration. For silicon steel the general form of these curves is shown in Fig. 4, which also gives the corresponding curves of μ_p . A second family of curves giving the value of μ_Δ/θ against H_p for various values of B_Δ can also be experimentally determined, the form of these curves for silicon steel being as shown in Fig. 5.

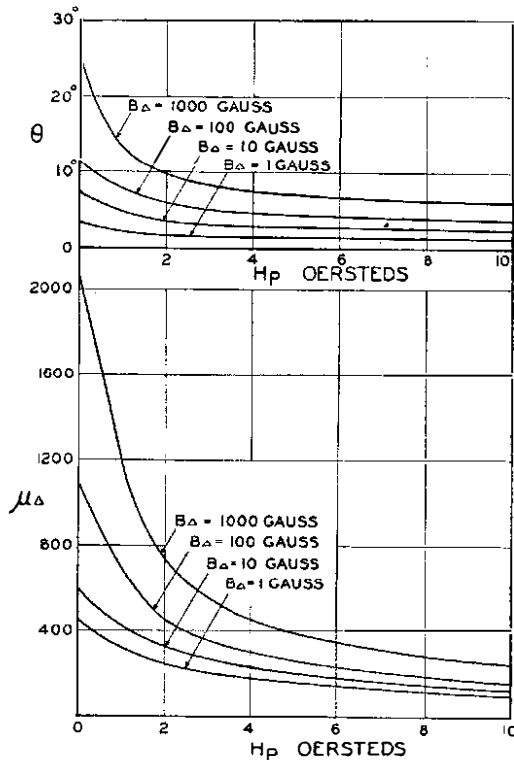

FIG. 5.—CURVES OF INCREMENTAL PERMEABILITY.

These two sets of curves contain all the experimental data relating to the core material which are necessary for the design of gapped chokes and transformers in the region of low distortion as defined by the B.S.I. Specification.²

Owing to the effect of eddy currents in the core stampings, the curves will vary with the frequency of the alternating magnetising force; however,

²This method of presenting the data was suggested by Mr. E. V. D. Glazier and Dr. K. A. Macfadyen.

with 14 mil sheet, 4 per cent. silicon steel the change up to 800 c/s is very small.³

Theory of the Air-gapped Magnetic Circuit.

In considering the theory of a coil having a core of ferromagnetic material with an air gap, the following simplifying assumptions will be made:—

- (a) The core is of uniform cross-section.
- (b) The length of the gap is small compared with the cross-sectional dimensions of the core, so that very little fringing of the flux occurs at the edges of the gap.
- (c) Flux leakage is negligible, so that at any instant the total flux in all parts of the core is the same, and is equal to the total flux in the gap.

Some of these assumptions, particularly (b), do not hold accurately in practice, but the general conclusions still apply.

From elementary magnetic theory the following relationship holds for any closed magnetic circuit.

$$\Phi = F/S$$

where Φ is the total flux (in Maxwells),

F is the applied magnetomotive force (in Gilberts),

S is the total reluctance (in Gilberts per Maxwell).

If the magnetomotive force is due to a current I amperes in a winding of N turns, the equation may be written:

$$BA = \frac{0.4\pi NI}{S} \dots\dots\dots(1)$$

where B is the flux density or magnetic induction in gauss, and A is the cross-sectional area of the core in sq. cm.

If l is the mean length of the flux path in the core, and δ the length of the air gap, both in cm., then

$$S = \frac{l}{A\mu} + \frac{\delta}{A\mu_a}$$

where μ is the permeability of the core and μ_a is the permeability of air. Since μ_a is numerically equal to 1⁴, the expression becomes

$$S = \frac{l}{A} \left(\frac{1}{\mu} + x \right) \text{ where } x = \frac{\delta}{l}$$

x will be called the gap ratio.

Hence from equation (1),

$$B = \frac{0.4\pi NI}{l \left(\frac{1}{\mu} + x \right)} \dots\dots\dots(2)$$

³This is true notwithstanding the fact that it is commonly found that the inductance of a choke at a given polarisation falls with increase of frequency even below 800 c/s. The reason for this is that the inductance is usually measured at a fixed applied alternating voltage. As shown later (equation 8), the incremental flux density is then approximately inversely proportional to the frequency. Since μ_Δ increases with B_Δ as shown in Fig. 5, a higher inductance is obtained at the lower frequencies.

⁴According to modern ideas, permeability is not a pure numeric. Although, therefore, μ_a is equal to 1 gauss per oersted, it should be retained in the equations if the dimensions of all terms are to be the same. For simplicity, μ_a is omitted in the present article. The expressions developed hold numerically, provided the quantities involved are measured in the units stated.

When the current I contains an alternating component (I_a) superposed on a polarising component (I_p) the equation may be applied either to polarising or incremental quantities, i.e.

$$B_p = \frac{0.4\pi N I_p}{l \left(\frac{1}{\mu_p} + x \right)} \dots \dots \dots (3)$$

$$\text{and } \hat{B}_\Delta = \frac{0.4\pi N \hat{I}_\Delta}{l \left(\frac{1}{\mu_\Delta} + x \right)} \dots \dots \dots (4)^5$$

The values of magnetic induction (polarising or incremental) in core and gap are equal, but the values of the magnetising force are not. In the gap the magnetising force (in oersteds) is equal numerically to the magnetic induction in gauss. In the core the magnetising force is equal to the magnetic induction divided by the appropriate value of permeability, i.e. if H_p and \hat{H}_Δ are the polarising and incremental magnetising forces respectively in the core,

$$H_p = \frac{B_p}{\mu_p}$$

$$\text{and } \hat{H}_\Delta = \frac{\hat{B}_\Delta}{\mu_\Delta}$$

The quantity $\frac{0.4\pi N I_p}{l}$ has the dimensions of

magnetising force and will be denoted by H_p^* . It is the value which the magnetising force would have if the magnetic circuit were homogeneous and of length l ⁶.

From equation (3),

$$H_p^* = B_p \left(\frac{1}{\mu_p} + x \right) \\ = H_p (1 + \mu_p x)$$

$$\text{whence } x = \frac{1}{\mu_p} \left(\frac{H_p^*}{H_p} - 1 \right)$$

For any given value of \hat{B}_Δ , μ_p and H_p are connected by one of the curves shown in Fig. 4, and values of x against H_p can be derived for various values of H_p^* . Fig. 6 shows a family of such curves for 4 per cent. silicon steel at low values of \hat{B}_Δ (less than about 100 gauss), when the magnetisation curve is not appreciably affected by the value of \hat{B}_Δ . Sets of curves for higher values of \hat{B}_Δ would, however, be of the same form.

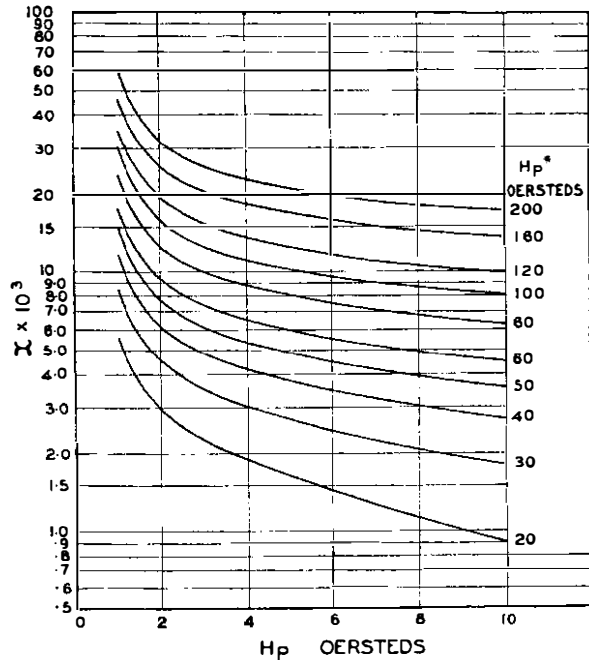

FIG. 6.—CURVES OF AIR GAP RATIO.

If the inductance to alternating current (i.e. the incremental inductance) in henrys is denoted by L_Δ , then from elementary theory,

$$L_\Delta = \frac{\hat{B}_\Delta AN}{\hat{I}_\Delta} \times 10^{-8} \dots \dots \dots (5)$$

From equations (4) and (5),

$$L_\Delta = \frac{0.4\pi N^2 A}{l \left(\frac{1}{\mu_\Delta} + x \right)} \times 10^{-8} \dots \dots \dots (6)$$

The reciprocal of the permeability of any substance is called its reluctivity and is denoted by the symbol ν . Thus the incremental reluctivity (ν_Δ) of the core is equal to $1/\mu_\Delta$. The quantity $(1/\mu_\Delta + x)$ is the reluctivity of a hypothetical homogeneous material having the same dimensions as the core and having the same total incremental reluctance as the actual core plus the air gap. It will, therefore, be called the apparent incremental reluctivity and denoted by ν_Δ^* .

Hence

$$L_\Delta = \frac{0.4\pi N^2 A}{l \nu_\Delta^*} \dots \dots \dots (7)$$

From Figs. 5 and 6, families of curves of ν_Δ^* against H_p for various values of H_p^* can be derived, a separate family being obtained for each value of \hat{B}_Δ . Such a family is shown in Fig. 7, which applies to 4 per cent. silicon steel for values of \hat{B}_Δ up to about 10 gauss, when ν_Δ^* is little affected by the precise value of \hat{B}_Δ . The curves for higher values of \hat{B}_Δ would be similar in shape.

Effect of varying the Air-Gap of a given coil.

The effect on the incremental inductance of varying the air-gap of a given coil can now readily be derived.

⁵As already explained, μ_Δ is a vector quantity. The reluctances of core and gap are therefore analogous to two impedances having different phase angles, and must be added vectorially, not numerically. It has, however, been found that the error introduced into any practical design of smoothing choke by neglecting the phase angle of μ_Δ is, for silicon steel, quite small. In the present simplified treatment, therefore, the phase angle has been assumed to be zero.

⁶ H_p^* differs slightly from the quantity H_p used by Glazier (Reference *m*) which in the notation of the present article is equal to $\frac{0.4\pi N I_p}{l + \delta}$.

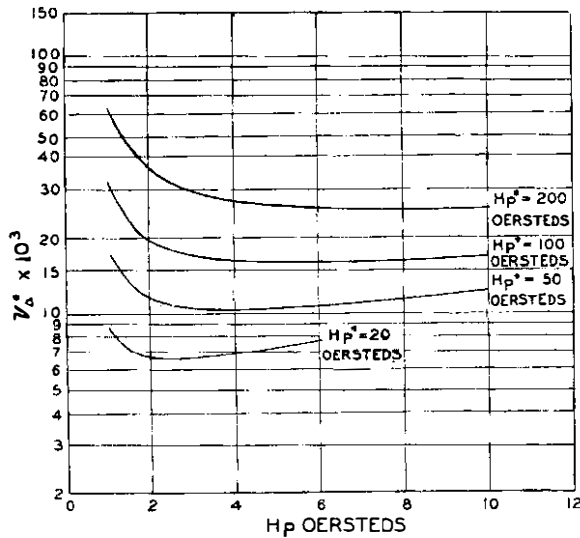

FIG. 7.—CURVES OF APPARENT RELUCTIVITY.

It is assumed that the polarising current and the magnitude and frequency of the applied A.C. voltage remain constant as the gap is varied. It is further assumed that the D.C. resistance of the winding is small compared with the A.C. impedance under the test conditions (this is almost always true in practice). The applied A.C. voltage is then equal to the induced E.M.F.; hence from elementary transformer theory,

$$V_{\Delta} = \sqrt{2} \pi \hat{B}_{\Delta} A n f \times 10^{-8} \text{ volts}$$

where f is the frequency and V_{Δ} the R.M.S. magnitude of the applied A.C. voltage

$$\text{and therefore } \hat{B}_{\Delta} = \frac{V_{\Delta} \times 10^8}{\sqrt{2} \pi A n f} \text{ gauss} \dots\dots\dots (8)$$

\hat{B}_{Δ} therefore remains unaltered as the gap is varied. Since I_p is constant so also is H_p^* . Hence for any gap the value of H_p can be found from the curve in

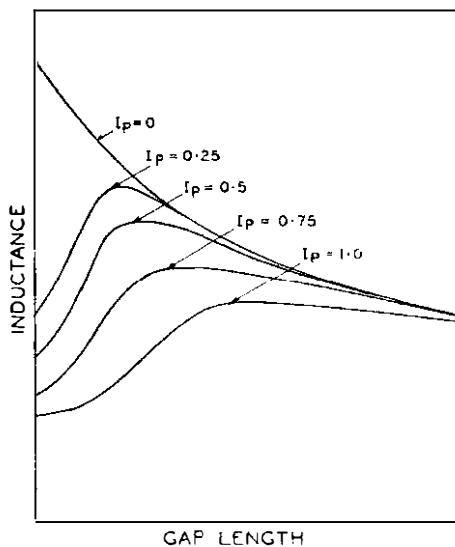

FIG. 8.—VARIATION OF INDUCTANCE WITH LENGTH OF AIR GAP.

Fig. 6 corresponding to the value of H_p^* . The variation of v_{Δ}^* with H_p is given by the appropriate curve of Fig. 7. It is evident that v_{Δ}^* is a minimum for a particular value of H_p , and the corresponding gap ratio can be found from Fig. 6. For this value of gap ratio, the inductance of the coil will be a maximum. If a different value of I_p and therefore also of H_p^* is chosen, the minimum value of v_{Δ}^* will be changed, and will occur at a different value of H_p and therefore of gap ratio. This is illustrated in Fig. 8 which shows the manner in which the inductance of a typical coil varies with gap length for various values of polarising current.

From Figs. 6 and 7 and similar families of curves for other values of \hat{B}_{Δ} it is a simple matter to derive curves of the minimum value of v_{Δ}^* (denoted by $v_{\Delta}^*_{min}$), and of the corresponding value of gap ratio (denoted by x_0), against H_p^* for various values of \hat{B}_{Δ} . These curves are shown in Fig. 9.

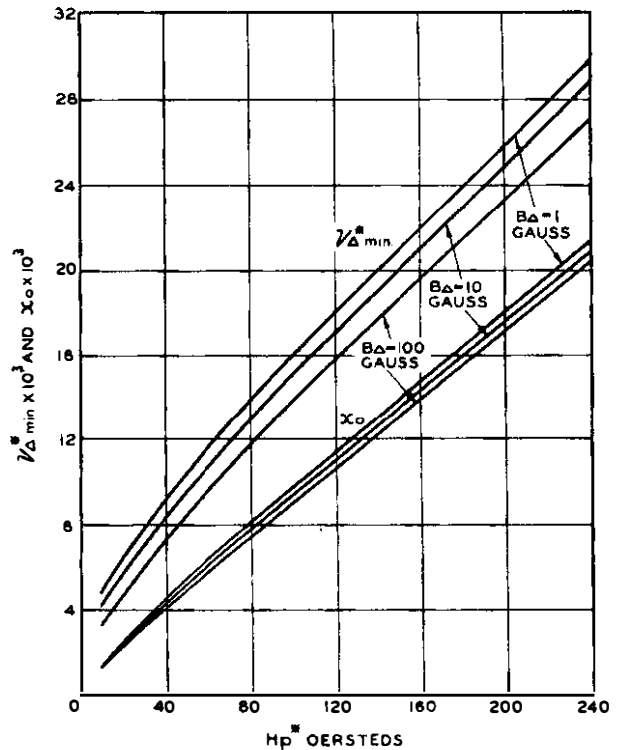

FIG. 9.—VARIATION OF MINIMUM APPARENT INCREMENTAL RELUCTIVITY AND OPTIMUM GAP RATIO WITH H_p^* .

Determination of the best design of a choke for a given performance.

The foregoing method and results are similar in some respects to those described by Hanna and extended by Glazier (References (j) and (m)). These methods, as well as several others, aim at the determination of the maximum inductance which can be obtained from a core of known dimensions wound with a given number of turns, for any conditions of polarising current and applied A.C. voltage. The practical problem in the design of smoothing chokes for floating battery installations is, however, to

determine the best dimensions of the core and number of turns, given the following particulars :—

- Polarising current (normally the maximum current which the choke is designed to carry).
- Magnitude and frequency of applied A.C. voltage.
- Incremental inductance and D.C. voltage drop under the above conditions.

The present method of designing a choke to meet such requirements is based on the experimental fact that for any value of \hat{B}_Δ , $\nu_\Delta^*_{min}$ can be expressed as a simple function of H_p^* by the empirical formula, $\nu_\Delta^*_{min} = \alpha H_p^{*\beta}$ where α and β are constants depending on the core material and on \hat{B}_Δ and the frequency. For 4 per cent. silicon steel the variation of α and β with \hat{B}_Δ for small values of \hat{B}_Δ , and over the lower audio frequency range, is negligible, so that for values of \hat{B}_Δ up to 10 gauss a single pair of values for α and β may be assumed. It is fortunate that higher values of \hat{B}_Δ occur infrequently in smoothing chokes for floating battery installations. In developing the design method, it will first be assumed that \hat{B}_Δ does not exceed 10 gauss; reference will be made later to the more complicated problem when \hat{B}_Δ has larger values.

The values of α and β can be determined by plotting the curves of Fig. 9 to logarithmic scales, and drawing a mean straight line through the experimental points. It is found that for 4 per cent. silicon steel the equation is then accurate within ± 5 per cent. over a range of H_p^* from 20 to 200 oersteds, which covers the practical values. Typical values of H_p^* occurring in actual chokes are given in the following table. The table also includes the values of other design parameters to which reference will be made later.

PARTICULARS OF TYPICAL SMOOTHING CHOKES

Current rating I_p amps.	Inductance L_Δ milli-henrys	Volt drop V_p volts	Approx. weight lbs.	H_p^* oersted	$k_1 = \frac{aN}{l^2}$	$k_2 = \frac{\lambda}{\sqrt{A}}$	$\frac{\gamma}{l} = \frac{\sqrt{A}}{l}$
1	700	5.4	11	35	0.0064	0.5	0.14
10	40	1.9	33	73	0.0123	0.4	0.11
200	1.3	0.45	260	110	0.0085	5.5	0.08
500	0.72	0.40	730	130	0.0082	5.4	0.11
1500	0.079	0.17	780	130	0.0076	5.3	0.11
2200	0.064	0.30	1460	150	0.0046	8.6	0.07

It may be assumed that, whatever the shape and size of core and number of turns, the gap will be adjusted to the optimum value for the specified polarising and incremental conditions. Hence equation (7) can be rewritten

$$L_\Delta = \frac{0.4\pi N^2 A}{l \nu_\Delta^*_{min}} \times 10^{-8} \dots \dots \dots (9)$$

Also by definition $H_p^* = \frac{0.4\pi N I_p}{l} \dots \dots \dots (10)$

A third equation is required involving the D.C. voltage drop in the choke (V_p).

$$V_p = I_p R = \rho \frac{\lambda N I_p}{a} \dots \dots \dots (11)$$

where R is the D.C. resistance of the winding.

ρ is the resistivity of the conductor.

λ is the mean length of turn.

a is the cross-sectional area of the conductor.

It is convenient to make the following substitutions :

$$k_1 = \frac{aN}{l^2} \dots \dots \dots (12)$$

and $k_2 = \frac{\lambda}{\sqrt{A}} \dots \dots \dots (13)$

From purely geometrical considerations of reasonable shapes of core and winding, k_1 and k_2 will not vary much, though k_1 will tend to be smaller for very heavy current chokes in which, to assist cooling, the winding conductor fills only a small percentage of the available winding space. In the development of design formulæ, k_1 and k_2 will be assumed constant.

From equations (11), (12) and (13)

$$V_p = \frac{I_p \rho k_2 N^2 \sqrt{A}}{k_1 l^2} = \frac{I_p K N^2 \sqrt{A}}{l^2} \dots \dots (14)$$

where $K = \rho \frac{k_2}{k_1}$

The ratio $\frac{\sqrt{A}}{l}$ will be called the core-shape factor,

denoted by γ . For a short core of large cross-sectional area, γ will be large, whereas for a long thin core γ will be small. The determination of the best value of this parameter is part of the design problem. Substituting $\sqrt{A} = \gamma l$ in equations (9) and (14),

$$L_\Delta = \frac{0.4\pi N^2 \gamma^2 l}{\nu_\Delta^*_{min}} \times 10^{-8} \dots \dots \dots (15)$$

and $V_p = \frac{I_p K N^2 \gamma}{l} \dots \dots \dots (16)$

From equations (10), (15), (16) and the empirical equation

$$\nu_\Delta^*_{min} = \alpha H_p^{*\beta} \dots \dots \dots (17)$$

the unknown quantities N , $\nu_\Delta^*_{min}$ and H_p^* can be eliminated and the following solution found for l , the magnetic length of the core

$$l = \left[\frac{\alpha^2 L_\Delta^2 K^{2-\beta} I_p^{2+\beta} \times 10^{16}}{(0.4\pi)^{2-2\beta} \gamma^{2+\beta} V_p^{2-\beta}} \right]^{\frac{1}{4+\beta}} \dots \dots (18)$$

Hence the volume of the core = $Al = \gamma^2 l^3$

$$= \left[\frac{\gamma^{2-\beta} K^{3(2-\beta)} \alpha^6 L_\Delta^6 I_p^{3(2+\beta)} \times 10^{48}}{(0.4\pi)^{6(1-\beta)} V_p^{3(2-\beta)}} \right]^{\frac{1}{4+\beta}} \dots (19)$$

Solving equations (10) and (16) for H_p^* and N ,

$$H_p^* = 0.4\pi \left(\frac{V_p I_p}{l K \gamma} \right)^{\frac{1}{2}} \dots \dots \dots (20)$$

and $N = \left(\frac{V_p l}{I_p K \gamma} \right)^{\frac{1}{2}} \dots \dots \dots (21)$

When H_p^* has been determined, the value of x_o , the optimum gap ratio, can be found from Fig. 9.

As stated above, K is approximately a constant for all chokes using the same conductor (invariably copper) for the winding. α and β are experimentally determined for the core material in question. The only remaining unknown parameter is γ .

Optimum Value of γ , the Core-shape Factor.

By choosing various values for γ , it is possible to design a whole range of chokes with cores of different shapes, all giving the same inductance and voltage drop at the specified polarising current. The most suitable choke may be selected from any one of the following considerations, depending on circumstances,

- (a) Minimum volume.
- (b) Minimum weight.
- (c) Minimum cost.

Dealing first with condition (a), it is evident from equation (19) that the volume of the core of a choke satisfying the performance requirements is proportional to $\gamma^{\frac{2-\beta}{4+\beta}}$.

$$\begin{aligned} \text{The volume of the winding conductor} &= Na\lambda \\ &= k_1 k_2 l^2 \sqrt{A} \\ &= \frac{k_1 k_2}{\gamma} \times lA \\ &= \frac{k_1 k_2}{\gamma} \times \text{volume of core} \end{aligned}$$

Hence total volume of core plus winding conductor is proportional to

$$\left(\frac{k_1 k_2}{\gamma} + 1 \right) \gamma^{\frac{2-\beta}{4+\beta}}$$

By differentiating this with respect to γ and equating to zero, it can be shown that the total volume is a minimum when

$$\gamma = \frac{2(1+\beta)}{2-\beta} k_1 k_2 \quad \dots \dots \dots (22)$$

It will be seen that the optimum value of γ depends on β , which is determined by the core material, and on k_1 and k_2 which are approximately constants for all chokes. For 4 per cent. silicon steel β does not vary much with frequency or \hat{B}_Δ (for values below 10 gauss). Hence it follows that for a given core material, a single value of γ will give minimum volume for all chokes irrespective of inductance or current rating, provided the characteristics are specified in the manner assumed, i.e., the inductance value and voltage drop to be obtained at a certain polarising current.

The densities of 4 per cent. silicon steel and copper are approximately in the ratio 1:1.2; the value of γ giving minimum weight is therefore 1.2 times the value giving minimum volume. The costs per unit volume of 4 per cent. silicon steel and copper are in the ratio of about 1 to 2, so that the value of γ giving minimum cost of core material and copper would be about twice the value giving minimum volume. However, the labour and overhead costs of a choke with this value of γ would exceed those of one designed for minimum volume, on account of its greater size. To determine the value of γ giving minimum total cost it is necessary to know how these other costs depend on the various design factors.

Practical Values of Constants.

From the dimensions of a large number of chokes, of which a few examples are listed in the table, the

mean value of k_1 may be taken as 0.007 and of k_2 , 6.5; for copper (hot) $\rho = 1.9$ microhm-cms, say, and hence $K = \rho k_2 / k_1 = 1.76 \times 10^{-3}$. For 4 per cent. silicon steel, and for values of \hat{B}_Δ not exceeding 10 gauss, average experimental values of α and β are 0.00105 and 0.6 respectively.

With these values, from equation (22), the value of γ for chokes of minimum volume is about 0.1, and for minimum weight about 0.12. The curves of volume or weight against γ are quite flat in the region of the minimum, so that the difference in either weight or volume between a choke designed for minimum volume and one designed for minimum weight is very small. The values of γ obtained from actual chokes given in the table suggest that chokes are in practice normally designed for minimum weight or volume.

Taking $\gamma = 0.1$, equation (19) becomes

$$\text{Volume of core} = 4700 \frac{I_p^{1.59} L_\Delta^{1.30}}{V_p^{0.91}} \text{ cm}^3 \quad \dots \dots \dots (23)$$

$$\begin{aligned} \text{and Total volume} &= 6900 \frac{I_p^{1.59} L_\Delta^{1.30}}{V_p^{0.91}} \text{ cm}^3 \\ &= 0.24 \frac{I_p^{1.59} L_\Delta^{1.30}}{V_p^{0.91}} \text{ cubic ft.} \quad \dots (24) \end{aligned}$$

The total volume of the complete choke in case will usually lie between 5 and 10 times the volume given by the above formula. Again assuming the same values of constants,

$$\text{Total weight of core and winding} = 120 \frac{I_p^{1.59} L_\Delta^{1.30}}{V_p^{0.91}} \text{ lbs.} \quad \dots \dots \dots (25)$$

$$\begin{aligned} \text{Equation (18)} \\ \text{becomes } l &= 78 \frac{I_p^{0.58} L_\Delta^{0.43}}{V_p^{0.59}} \text{ cm} \quad \dots \dots \dots (26) \end{aligned}$$

From this equation and equations (20) and (21), all the design data necessary for the construction of the choke can be derived.

Value of Incremental Flux Density.

The numerical values of α and β in the above formulæ apply to 4 per cent. silicon steel for values of \hat{B}_Δ up to 10 gauss. The same design method can be applied when \hat{B}_Δ has larger values, provided the appropriate values of α and β have been experimentally determined. A preliminary design can be made on the assumption that \hat{B}_Δ is not greater than 10 gauss; when A and N have been calculated, the value of \hat{B}_Δ can be found from equation (8). If the value exceeds 10 gauss, the design can be modified using the appropriate values of α and β . The method is one of successive approximation, but fortunately α and β do not vary rapidly with \hat{B}_Δ , so that one redesign will usually be sufficient.⁷ In chokes designed for floating battery equipment employing generators, \hat{B}_Δ will almost invariably be

⁷From equations (9), (10) and (17) a formula for AN can be developed which enables the approximate value of B_Δ to be determined without making a complete preliminary design.

less than 10 gauss. When rectifiers are employed, a larger value of \hat{B}_Δ will usually occur in the first choke of the filter.

Effect of Temperature Rise on Design.

In the method of design given above, no account has been taken of the temperature rise of the winding. It has been assumed that the design is limited by the permissible voltage drop. It is possible to make an approximate estimate of the temperature rise with any given design of choke by calculating the power dissipated per square centimetre of winding surface. This value should not exceed about 0.1 watt for a 40°C maximum temperature rise. The surface area of the winding will be approximately proportional to l , the magnetic length of the core, and to the mean length of turn, λ . λ has already been assumed proportional to \sqrt{A} , so that the surface area can be written $k_3 l \sqrt{A}$ where k_3 is a constant. From data derived from a large number of chokes, the average value of k_3 for shell-type chokes with a single winding is 1.8, and for core-type chokes with two windings, 3.6 (when temperature rise is likely to be a serious factor the latter type of construction would normally be used). The power dissipated in the winding is $V_p I_p$, and hence if w is the power per square centimetre,

$$w = \frac{V_p I_p}{k_3 l \sqrt{A}} = \frac{V_p I_p}{k_3 \gamma l^2} \dots\dots\dots(27)$$

Substituting the value of l of equation (25),

$$w = 4.6 \times 10^{-4} \frac{V_p^{1.6}}{I_p^{0.13} L_\Delta^{0.67}} \dots\dots\dots(28)$$

for core-type, two-winding chokes.

For shell-type, single-winding chokes the value of w is twice that given by the above formula.

It is evident that, with chokes designed according to the method described, temperature rise will be

greatest when the voltage drop is large or the incremental inductance value small, the current rating having little effect. The permitted voltage drop for chokes used in filters of floating battery installations does not vary much. With economically designed filters, values of inductance small enough to give a large temperature rise occur only in filters for very heavy current ratings. When the estimated power per square centimetre for any design is excessive, the dimensions of the choke can be slightly increased. This will have the effect of increasing the radiating surface and reducing the voltage drop and therefore the total power dissipated.⁸

Application of the Method.

The method described gives the best design of a choke having a certain inductance at the rated polarising current, the way in which the inductance value increases as the polarising current is reduced below the rated value being assumed to be of no importance. With chokes designed according to this method, the inductance with no polarising current will usually be about 30 per cent. greater than the value at the rated polarising current. For some special applications, a choke may be required of which the inductance value is either very constant over a wide range of polarising currents or varies in some definite way. Such instances require special treatment.

When the method is applicable, equations (24) and (25) can be used to give a rapid estimate of the probable size, weight and cost of a choke, without the necessity of working out the design in detail. This is of particular value where very large chokes are concerned, since accommodation and strength of flooring are then often serious problems.

⁸Design formulæ can be developed based on a specified value of w instead of a specified value of V_p , but these are not given here owing to lack of space.

REFERENCES

GENERAL

(a) B.S.S. 933-1941 Magnetic Materials for use under combined D.C. and A.C. magnetisation.

(b) "Incremental Permeability and Inductance." L. G. A. Sims. *Wireless Engineer*, January and February, 1935.

(c) "Incremental Magnetisation." L. G. A. Sims and D. L. Clay. *Wireless Engineer*, May and June, 1935.

(d) "The Specification of Magnetic Properties." L. G. A. Sims. *Engineering*, Vol. 140, p. 290.

(e) "Ballistic Measurements in Incremental Magnetism." L. G. A. Sims and J. Spinks. *Engineering*, Vol. 146, p. 406.

(f) "The Time-decrease of Permeability at Low Magnetising Forces." C. E. Webb and L. H. Ford. *J.I.E.E.*, Vol. 75, p. 787.

(g) "Flux Distortion in Iron Testing." J. Greig and J. E. Parton. *Engineering*, Vol. 144, p. 439.

(h) "Harmonic Power in Iron Testing." J. Greig and J. E. Parton. *Engineering*, Vol. 146, p. 431.

(i) "Non-linear Distortion in Iron Testing." J. Greig and E. Franklin. *Engineering*, Vol. 148, p. 395.

DESIGN OF AIR-GAPPED CHOKES

(j) C. R. Hanna. *Journal A.I.E.E.*, 1927, p. 128.

(k) R. T. Beatty. *Wireless Engineer*, February, 1934, p. 61.

(l) T. Tanasescu. *Wireless Engineer*, April, 1934, p. 197.

(m) "The Inductor with Air-Gapped Magnetic Circuit." E. V. D. Glazier. *Engineering*, Vol. 148, p. 406.

MEASUREMENT OF INCREMENTAL PROPERTIES

(n) "Instruments for the Measurement of Incremental Permeability." D. C. Gall. *Engineering*, Vol. 146, p. 348.

(o) "Rings and Small Transformer Cores in Incremental Magnetic Testing." E. V. D. Glazier and J. E. Parton. *Engineering*, Vol. 146, p. 573.

(p) "The Effect of Joints in a Laminated Iron Core." H. W. Phear and R. R. M. Mallock. *J.I.E.E.*, Vol. 79, p. 561.

The Production of the Post Office Electrical Engineers' Journal

H. LEIGH, B.Sc. (Eng.), A.M.I.E.E.

U.D.C. 655.2

Brief details are given of the processes involved in the production of this Journal and of the machines employed.

Introduction.

IT is a third of a century since the Institution of Post Office Electrical Engineers first published this technical journal, and it has been produced regularly every quarter since. It is interesting to look back on the early issues of the JOURNAL and note the subjects then contributed, the authors who wrote them and the general style of the production. In the first volume alone, articles appeared by five men who in turn held the post of Engineer-in-Chief to the British Post Office and one who became Director-General of the Australian Posts and Telegraphs Department

As regards the style of production, the JOURNAL has undergone one major change in these 33 years. This was in 1927 when the size of the page was changed from octavo to demy-quarto, two columns of type being introduced instead of one. More recent changes were made in July, 1931, when the Supplement was introduced and shortly afterwards, when the sizes of type employed in the JOURNAL were changed; in 1934 further alterations in the type faces were made and the present cover introduced. These changes were great successes and contributed to the steady increase in circulation which the JOURNAL has enjoyed.

The Board of Editors.

Before proceeding to the technicalities of the production of this JOURNAL, mention should be made of the Board of Editors,¹ which manages the JOURNAL'S affairs. The Board comprises a Chairman and two members who are appointed by the Council of the Institution of Post Office Electrical Engineers together with three officers, i.e., a Managing Editor, an Assistant Editor and a Secretary-Treasurer. This Board has power to co-opt additional members, and usually adds two or three more members to its numbers, so that all phases of the work of the Post Office Engineering Department may be represented.

THE TYPE SETTING STAGE

The first stage in the production of the JOURNAL commences with the receipt of the manuscript of an article. When this has been approved for publication by the Board, it is passed to the printer to be set up in type. At the same time the illustrations are detached for separate treatment.

Instructions regarding the type to be employed are sent to the printer with the manuscript. There are a great many varieties of type faces, the selection between many of which is largely a matter of personal choice, though some faces are specially suited to certain types of work, e.g., advertisement

displays. The type faces selected for the JOURNAL are:—

Main Headings	Gill
Short summary of each Article	Times Bold
Main Body of each Article	Old Style (Roman)

In addition to the style the size of type has also to be settled. Type size was once measured in "picas" but the modern unit is the "point" which is one-twelfth of a pica or $1/72$ nd of an inch. This means that if an article is printed in 10 point type the distance between lines is $10/72$ nds of an inch. The width of each letter varies and is measured in "ems." The em corresponds to the width of a square letter of pica type, i.e., to a width of $12/72$ in. The length of this line is 19 ems, i.e., $19 \times 12 \times 1/72$ in. = $3 \frac{1}{6}$ in. and the type used is 10 point. Regional Notes and Book Reviews are set in 9 point and the Supplement in 8 point type, each line length being 19 ems.

The Monotype Keyboard (Fig. 1)

Hand-setting of type has, for publications of this nature, long been replaced by automatic means. Of

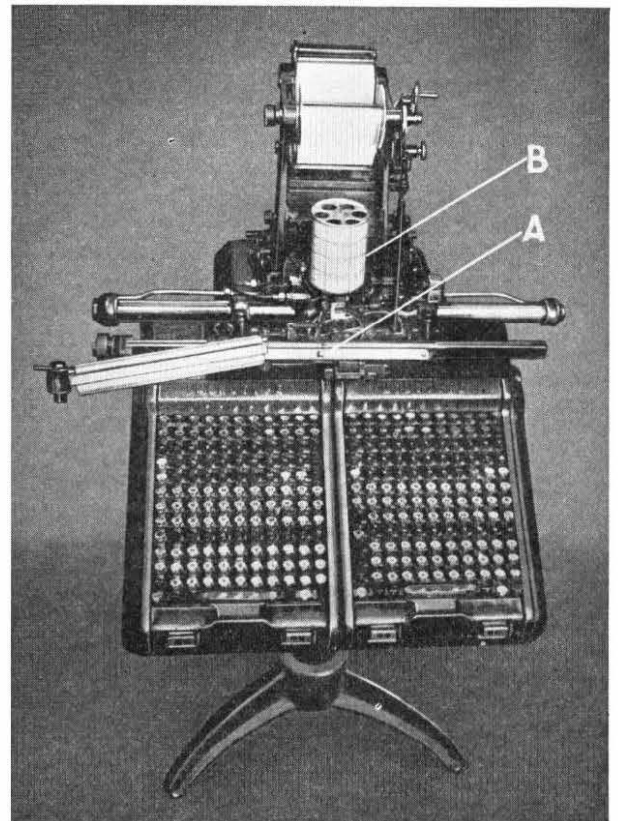

FIG. 1.—THE MONOTYPE KEYBOARD.

¹For the present constitution of the Board see p. 150

these the monotype and linotype machines are both suitable, each having its own advantages. Until recently linotype was employed for setting articles in this JOURNAL, but for the last four volumes monotype has been used. As the names imply, each character in monotype is cast separately whereas in the linotype process each line is cast as a single unit.

The first stage in the monotype process is the punching of slip, similar to Wheatstone slip, but about 4 in. wide. A specimen containing a line of 12 ems is shown in Fig. 2. The punching process is controlled from a large keyboard, shown in Fig. 1, which can contain enough characters for six alphabets, e.g., ordinary face, capitals and lower case and sometimes small capitals; italics, capitals and lower case; and bold face capitals and lower case. Before punching is commenced the keyboard is connected to the punching mechanism by key bars. A different set of bars is necessary for each type face, the bars being "jacked in" below the keyboard.

The depression of the keys results in the paper slip being perforated in one or more holes per character. There are 31 positions in which the slip may be punched, arranged in two groups of 14 and 3 for special purposes. As each key is depressed a pointer A (Fig. 1) indicates to the operator how much of the allotted length of line remains. When this is too small to allow the next word to be included, the operator reads from the pointer and subsidiary scale B a number corresponding to the length of line left. This number, known as the justification figure, is then punched in the slip causing holes in one or more of the

The Casting Process.

The roll of punched slip is next passed through the casting machine in the reverse order from that of punching. The last line and the last letter of each line are cast before the others. In this way the justification figure for each line is received by the casting machine before any of the space punchings to which it relates, and the width of the spaces is thus adjusted in advance.

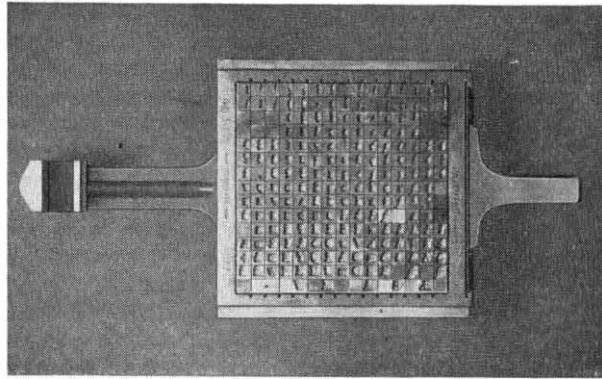

FIG. 3.—DIE CASE CONTAINING 225 MATRICES.

As with the punching machine the casting process is controlled by compressed air. Each line of holes in turn comes in register with 31 holes in a steel cylinder. Air passing through any hole where the paper has been punched pushes up a corresponding steel pin on the bed of the machine. As previously stated, the type selecting holes comprise two sets of 14. A maximum of one hole is punched in each group, resulting in 15 selections within each group (the fifteenth being when no hole is punched), or $15^2 = 225$ combinations.

Associated with the selecting pins is a fixed mould over which slides a die case, such as the one illustrated in Fig. 3, containing 225 matrices. A different die case is necessary for each type face. The die case slides face downwards with a forward and sideways motion, the travel in these two directions being arrested by any pins which have been pushed up by air passing through the slip. Thus the matrix of the particular character required is selected and positioned over the mould. It is held firmly in this position while molten metal is forced up into the mould from the reservoir. The moulded type is then ejected and lined up in column width ready for assembly.

Galley Proofs.

The type from the casting machine is accommodated in shallow metal trays approximately 2 ft. long and 6 in. wide known as slip galleys. Rough proofs are taken of the type and these are read by the printer's readers. Any mistakes found are rectified and further proofs are taken, three sets of which are sent to the Editors. One of these with the original manuscript is sent to the author for check, the second copy is sent to the Librarian at Dollis Hill for the Universal Decimal Classification number² to be

²P.O.E.E.J. Vol. 32, p. 56.

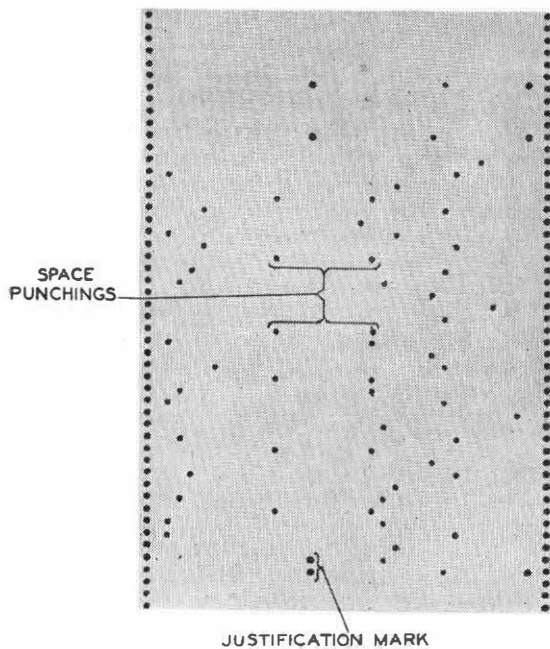

FIG. 2.—SPECIMEN OF MONOTYPE SLIP.

three special positions. These are used to increase the length of the spaces between the words so that the line is exactly filled. The punchings corresponding to the normal spaces and to the justification figure have been marked on the slip shown in Fig. 2.

added, and the third is read by the Editors. When the author and librarian have returned their copies of the galley proofs, one copy is marked to show all the additions and amendments necessary, the markings being made in the approved printer's sign language.³

ILLUSTRATIONS

Concurrently with the type setting the illustrations have been prepared. Authors' sketches have been drawn in Indian ink by the JOURNAL draughtsmen. A special technique is necessary to ensure that the diagram will be legible when it is reduced to the size required for reproduction in the JOURNAL. The size of lettering employed is particularly important. Whenever possible notes and descriptions, etc., are omitted from the diagram; long notes, if essential, may be set up in type under the illustration. Diagrams are normally reproduced in the JOURNAL in one of three standard widths—column width, i.e. 3 1/6 in., page width, i.e., 6 1/2 in. or an intermediate width of 4 in. The drawings produced by the draughtsmen are usually much wider than these, and a photographic reduction is made by the block maker as directed by the Editor. Photographs may require touching up, unessential details blocking out or reference letters adding before the prints are ready for the engraver.

Line Work.

Black and white diagrams are reproduced from line blocks made of zinc. A photographic negative is first made the correct size for the final block. A zinc plate is sensitised, placed in contact with the negative

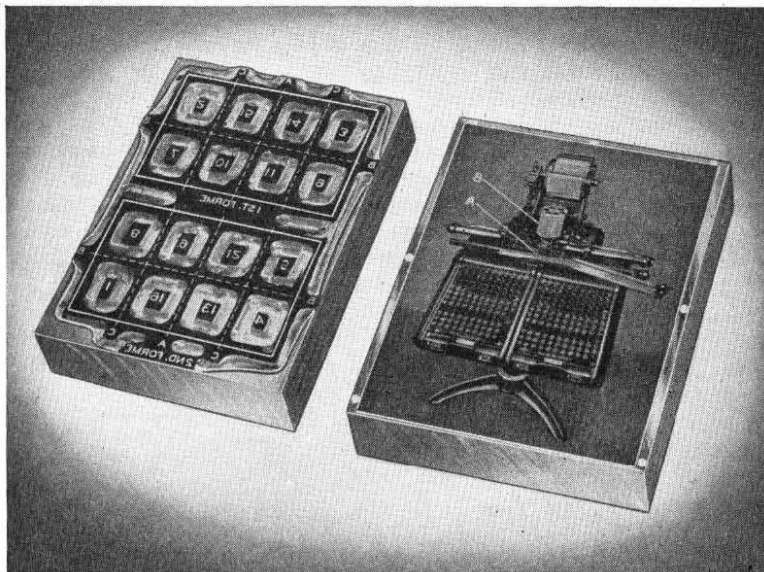

FIG. 4.—LINE AND HALF-TONE BLOCKS.

and exposed to the light of an arc lamp. After correct exposure, the plate is developed in much the same way as a paper photographic print would be treated. The image on the metal is then reinforced by dusting

³ cf. *The Stationery Office Guide*, Part II.

with bitumen which acts as an acid resistant. The plate is now ready for etching in a succession of baths of nitric acid which eats away the unprotected portions of the surface, leaving the image standing up in relief. After each bath, the sides of the image are protected from "underbiting" action of the acid, by brushing against them a red powder, known as dragon's blood, which, when subjected to heat, hardens and acts as an acid resistant. The top of the lines is also reinforced after each bath by rolling with greasy ink which, when hardened by heat, also acts as an acid resistant.

When sufficient depth has been reached, the plate is trimmed and cleaned, after which it is mounted on a wooden block of the correct thickness and despatched to the printers. Two proofs, known as pulls, from each block are sent to the Editors. A photograph of a line block is reproduced on the left of Fig. 4. The block is that from which Fig. 6 of this article was printed.

The Half-Tone Process.

Photographs are reproduced by a slightly different process. A negative is made by photographing the original print with a camera which incorporates a fine glass screen between the lens and the plate. This screen is composed of two pieces of optical glass, each of which has been ruled at an angle in a series of fine parallel lines and which are sealed together, the effect being a fine mesh made by the crossing of the lines at right angles. Each square acts as a separate lens, the position of the screen being adjusted to suit the subject and allow each square to produce a spot of light on the plate. The size of each spot depends on the intensity of illumination, a small spot corresponding to a dark part of the picture and a relatively large circle which may overlap the adjacent circles, corresponding to a light portion. Three separate exposures are made on the one plate using different stops to bring up the high lights, detail and shadows respectively. The finer the screen the more detail is shown in the final reproduction, provided the paper used in printing is of high enough quality and the rate of printing not exceptionally fast. For newspaper work, where cheap paper and a high rate of printing are essential, a coarse screen has to be employed and it is not difficult to identify on the reproduced photograph the individual dots formed by the mesh. For reproductions in the JOURNAL a much higher standard is attained, the mesh employed being 133 to the inch, i.e. 133² or 17,689 separate dots per square inch of block. Finer screens up to 200 to the inch are, on occasion, employed for special work. At the lower end of the scale screens of about 55 meshes to the inch represent the coarsest in ordinary use.

The production of the negative is followed by the printing on metal stage which is similar to that for line blocks, except that the metal employed for fine

screens is copper instead of zinc. The copper plate is coated with a combined solution of enamel and sensitising agent, the effect of light on which is to harden the sensitising agent. Consequently, when the plate is washed after exposure the unaffected solution is washed away, leaving the affected parts still coated. This image is then fixed by heat.

Etching in baths of iron perchloride follows, the interstices between the dots being eaten away, whereas the dots are protected by the enamel. The subsequent cleaning and mounting processes are similar to those for line blocks. In this way half-tone blocks such as that illustrated on the right of Fig. 4, which is a reproduction of the block from which Fig. 1 was printed, are produced. By the choice of a fine screen and a smooth imitation art paper, a high standard of reproduction is obtained, although, of course, some loss of detail is inevitable.

THE MAKE-UP

The next stage in the production of the JOURNAL is the "making-up" of each article. As each article is arranged to start at the beginning of a page, this can be done before the position which it will occupy in the JOURNAL has been settled. As soon as all corrected proofs have been received by the Editors, one copy of the corrected galley proofs, marked to show where each figure should be inserted, and with the block pulls bearing the captions and figure numbers attached, is returned to the printer.

Now the compositor gets to work. He is one of the most skilled men of the printing trade. He makes the article up in page formation and associates the blocks with the type. He arranges for the authors' corrections to be carried into the type and has any type which runs round a block, as round Fig. 5, reset in lines of the correct length. If the block is a small one he may set this up himself; but if the block requires more than, say, 15 lines to be reset, it is cheaper to pass the correction to the monotype operator. The selection of the right lines to be re-set so that the block comes exactly in the required place and is

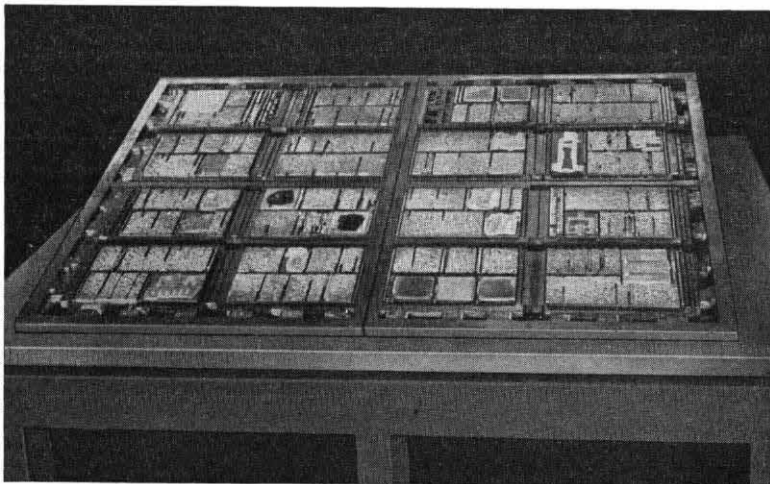

FIG. 5.—TWO 8-PAGE FORMES.

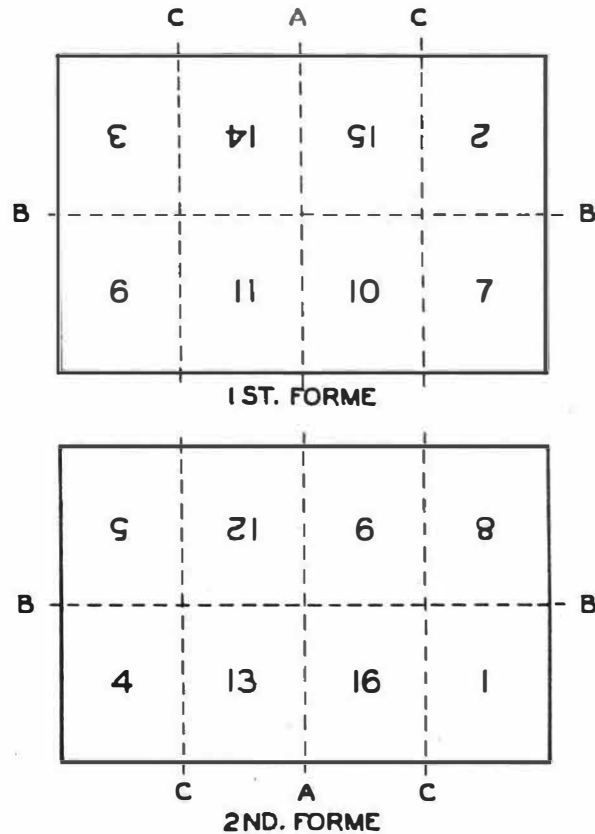

FIG. 6.—ARRANGEMENT OF PAGES FORMING A 16-PAGE UNIT.

just covered is at times a matter of considerable skill and experience. Any discarded type, known as printer's pie, goes back to the melting pot.

Blocks must be associated as closely as possible with the references in the text and attention must be paid to the "balance" of the page. Small points, such as avoiding paragraph headings near the bottom of columns, must also be watched if the article is to be both pleasing to the eye and easy to read.

The type at this stage is accommodated in trays similar to the slip galleys but wider to take two columns and known as page galleys. Proofs of the made-up article are read at the printer's works and revised proofs sent to the Editors, who re-read them, particular care being taken to check any reset matter, figure numbers, captions, etc., and to ensure that all corrections marked on the galley proofs have been incorporated. Checked proofs are returned to the printer and revised page proofs obtained, if necessary.

When the corrections have been carried out, the type has to be locked together and stored until required. The locking of the type is done in an open metal frame or chase, holding type for four, eight or sixteen pages. The flat metal-topped table on which

this operation is carried out is still known as a stone, from the days when it was stone or marble topped. "Furniture," comprising wood or metal strips, is placed round the type with wedges, known as quoins, to hold the type firmly in place. Two typical formes, as the type assembled in the chase is called, are shown in Fig. 5, the arrangement of pages being as shown in Fig. 6.

PRINTING

For printing and binding purposes the JOURNAL is divided into units of 16 pages, although 8 pages or even 4 pages have at times to be treated separately. The machines used to print the JOURNAL can handle

gripped to the cylinder by its forward edge and loosely held by "smoothers." After one revolution round the cylinder, during which it is printed, the paper is released and discharged on the far side of the machine. Drying solutions added to the ink and the light stacking of the printed sheets are sufficient to prevent smudging; but, if it is desired to run the sheets through the machine again the same day to print the other side, the sheets have to be sprayed with atomised paraffin wax. This is done by a series of jets, not shown in Fig. 7, which play on the sheet as it leaves the cylinder to be stacked.

The inking of the type is an elaborate process. Owing to the number, nature and disposition of the

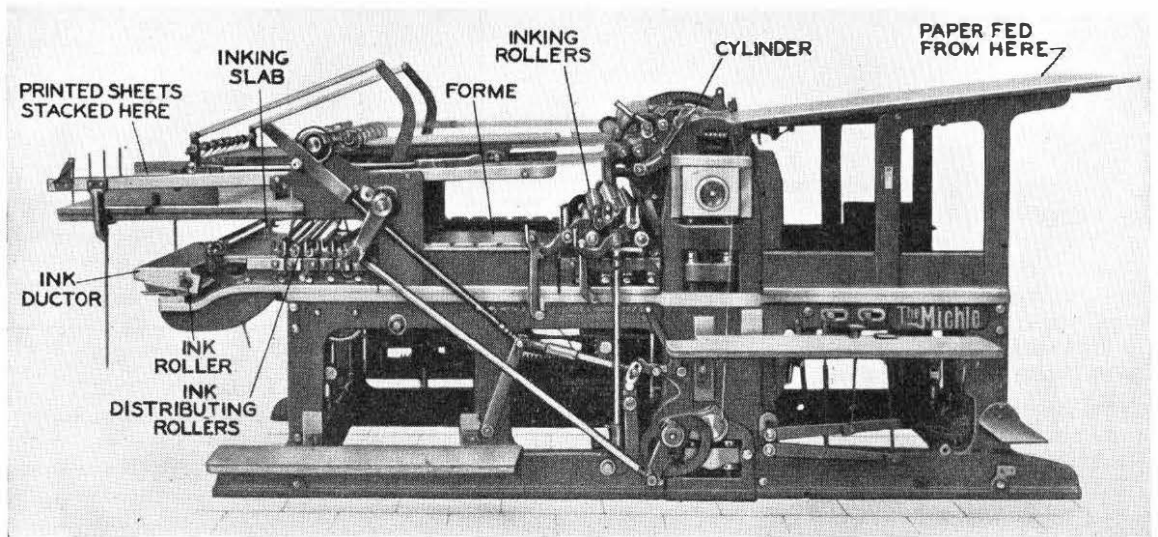

FIG. 7.—FLAT BED, CYLINDER TYPE PRINTING MACHINE.

a sheet 60 in. \times 40 in., but the sheet used for the JOURNAL, known in printing circles as the quad demy, is 45 in. \times 35 in. A quad demy is sixteen times the size of the JOURNAL page, which is demy quarto, and a quad demy therefore contains 32 JOURNAL pages, 16 being printed on each side. After printing, these sheets are divided into two, forming two units of 16 pages for binding purposes.

The printing machines are of the flat bed cylinder type illustrated in Fig. 7, and are about 20 ft. long and 10 ft. wide. The cylinder, which weighs about 1 ton, is mounted approximately centrally above the 2-ton bed. The bed, which carries the forme, has a reciprocating motion which takes the forme completely under the cylinder and out on the far side, where the forme is inked. The bed is shown in this position in Fig. 7. For each complete forward and return motion of the bed, the cylinder makes two revolutions, during the first of which it is in contact with the type but is lifted clear on the second revolution during which the bed returns to its home position.

The paper is fed on to the cylinder either by hand or by an automatic friction or suction device. It is

illustrations, the amount of ink required by the different portions of the forme varies. This is catered for by feeding the ink from the "ductor" or ink trough, which extends across the whole width of the machine, via an adjustable gap on to the ink roller. The gap is adjustable every inch of the length of the ductor by a series of keys. The ink roller revolves a portion of a turn each time the bed moves forward, the amount of revolution also being adjustable. The amount of ink taken from the ductor can thus be finely adjusted. A second roller transfers the ink from the ink roller to the inking slab where it is broken up by a series of loose rollers. The slab moves forward with the bed, and on the return journey transfers the ink to the inking rollers with which the forme comes in contact. This elaborate system allows a fine adjustment of the amount and distribution of the ink to be obtained.

As soon as the formes are assembled on a machine a final 16-page proof is taken and sent to the Editors for approval. At this stage only absolutely essential alterations are made. While the Editors are approving the proof the machine is made ready so that as soon as approval is given the run can commence.

ASSEMBLY

Folding

When the sheets have been printed on both sides and divided in two, the smaller sheets thus obtained are passed to the folding machine (Fig. 8). Here each sheet is fed in turn on to a moving band which carries the forward edge up an inclined slope (not shown) until a stop is reached. At this stage the middle of the sheet is at the bottom of the slope. As the second half of the sheet is still on the moving band the sheet bellies downwards at its centre point and is caught by two rollers which carry it forward, now folded in half along the line AA, (Fig. 6). A second moving band carries the sheet over a second pair of rollers at right angles to the first pair. This time the middle of the folded sheet is pushed into contact with the rollers by a saw-edged knife A (Fig. 8); the sheet is thus pulled through from the middle again and the second fold BB is accomplished. The third fold CC is made similarly at B (Fig. 8) without any manual assistance and the sheet leaves the machine folded three times into a 16-page unit.

Stitching.

When all the 16's comprising a JOURNAL have been similarly folded, they are "gathered" by hand—that is, copies of the various 16's are assembled in order. The next process is stitching. Each 16 is opened at its middle page, straddled across a bar on the stitching machine (Fig. 9) and swung into position below a group of three needles each fed with thread from bobbins mounted above. The machine makes three large stitches through each 16 and carries the three threads forward to make similar stitches through the next 16. When all the 16's comprising one copy have been stitched together, the first 16

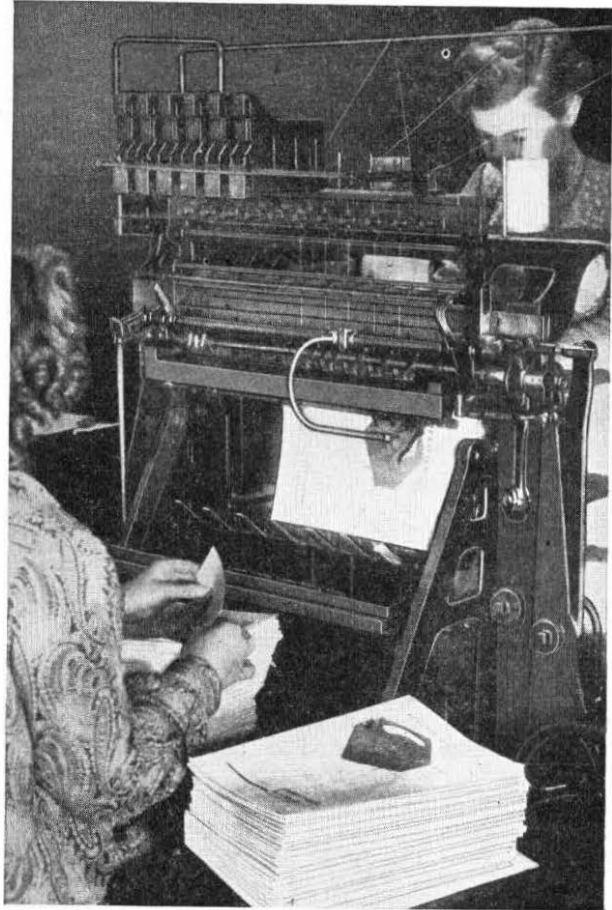

FIG. 9.—STITCHING MACHINE.

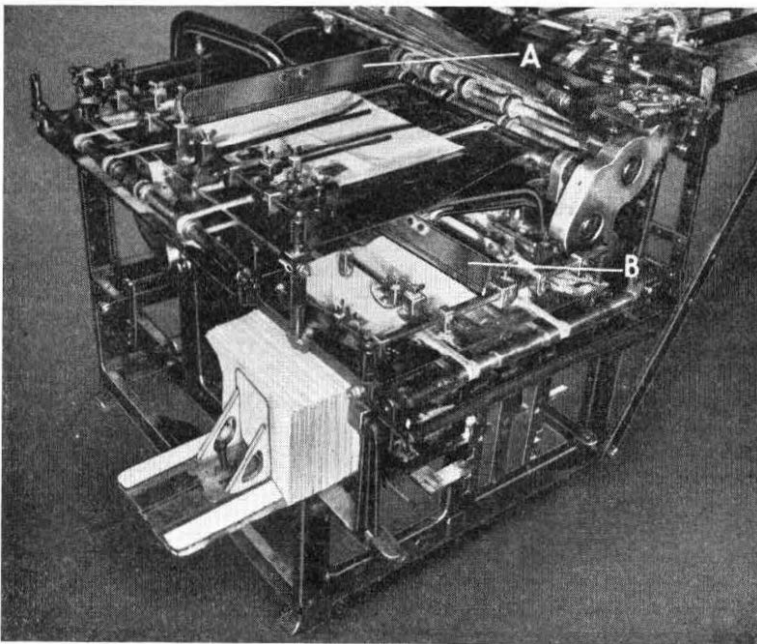

FIG. 8.—FOLDING MACHINE.

of the next copy is stitched to the last 16 of the preceding copy and so on. On the delivery side of the machine a second operator cuts the separate copies apart with a knife.

Assembling the Cover.

The cover has been separately printed on a small machine with an automatic feed and has now to be glued to the remainder of the JOURNAL. This is done by a simple manual process after which the whole JOURNAL is held clamped on a moving belt. When each JOURNAL has made one circuit of the belt the cover glue has dried sufficiently, the clamp opens and another freshly glued copy is put in its place.

The Guillotine.

As the individual pages of the JOURNAL were formed by folding a large sheet the edges have to be cut. It is difficult to assemble cut sheets in exact register, and the cutting and trimming are therefore left to last and combined in one

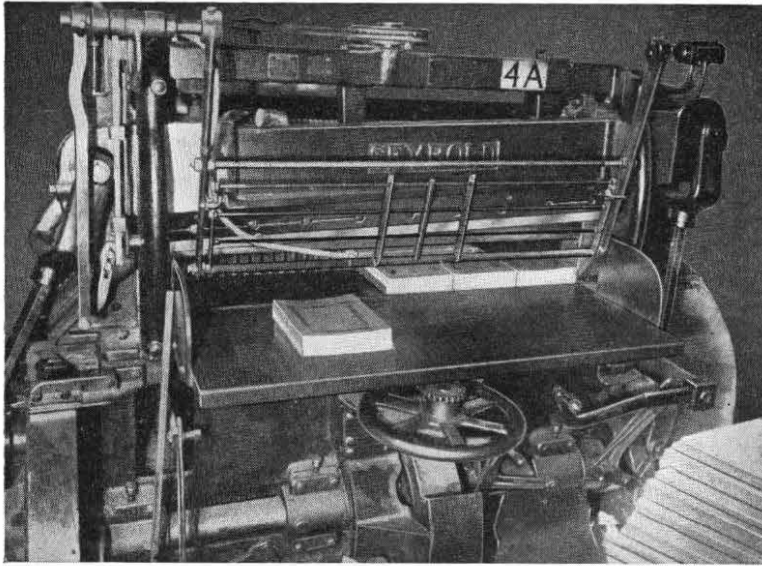

FIG. 10.—THE GUILLOTINE.

operation. The guillotine (Fig. 10) is a large power-driven knife which can cut through 9 or 10 in. of paper along its length of about 4 ft. The back plate of the machine is adjusted so that its distance from the blade is the one required. The copies of the JOURNAL are stacked and clamped and the huge blade cuts cleanly through. The operation is repeated for each edge.

THE SUPPLEMENT

The printing of the Supplement is similar to that described for the JOURNAL but in the assembly there are two minor points of difference. First the supplement is wire stapled instead of stitched and, secondly, it is punched with the standard four-hole punching for ease of filing. Both operations are carried out

on machines which are larger and power-driven editions of their office counterparts.

Finally, the Supplement is inserted by hand in the JOURNAL.

Conclusion.

For the Editors and printing staff the job of producing another JOURNAL is now over, but for the distributing staff, including the many JOURNAL agents throughout this country and abroad, their task is just commencing. Consignments, large or small according to the anticipated sales, are sent by van, by train, by post and by steamer. Copies go to telephone engineers throughout the world, although naturally by far the largest sale is to subscribers in this country.

And finally a word must be said about advertisements. As the JOURNAL is read by engineers in every important telecommunication administration in

the world, it is an excellent medium for advertising the products of British manufacturers, many of whom avail themselves of space in its pages. The revenue thus obtained makes a valuable contribution towards the expense of producing the JOURNAL and helps in keeping down the selling price.

Acknowledgment.

The author is indebted to Mr. J. Brake, of Messrs. Sanders Phillips & Co., Ltd., the printers of this JOURNAL, and to Mr. G. S. Lines, of the Engravers' Guild, who prepare the blocks of the illustrations, for help and advice in the preparation of this article, and for their ready assistance at all times in dealing with the many problems that arise in connection with the production of a journal of this nature.

TELEPHONE AND TELEGRAPH STATISTICS—SINGLE WIRE MILEAGES AS AT 31st MARCH, 1941 THE PROPERTY OF AND MAINTAINED BY THE POST OFFICE

REGION	OVERHEAD			UNDERGROUND		
	Trunks and Telegraphs	Junctions	Subscribers *	Trunks and Telegraphs †	Junctions ‡	Subscribers ¶
Home Counties	13,936	39,567	287,274	936,291	211,078	1,128,688
South Western	8,598	33,121	216,079	451,076	96,117	593,987
Midland	10,939	25,833	181,105	654,308	244,480	778,804
Welsh and Border Counties..	9,425	23,586	120,334	350,690	62,158	240,689
North Eastern	13,702	22,573	148,157	543,858	188,593	848,278
North Western	2,274	7,994	105,868	488,991	286,079	1,067,636
Northern Ireland	8,928	7,519	26,026	41,951	14,225	102,896
Scottish	24,152	31,734	162,280	469,313	157,208	628,951
Provinces	91,954	191,927	1,313,123	3,936,478	1,260,538	5,389,929
London	826	1,465	66,606	564,974	1,402,580	3,497,672
United Kingdom	92,780	193,392	1,379,729	4,501,452	2,663,118	8,887,601

* Includes all spare wires.

† All wires (including spares) in M.U. Cables.

‡ All wires (including spares) in wholly Junction Cables.

¶ All wires (including spares) in Sub's. and mixed Junction and Sub's. Cables.

The Economic Design of Manholes

J. P. HARDING, B.Sc.(Eng.)

U.D.C. 621.315.233

Part III—Design of a Typical Manhole

The last of this series of articles applies the formulæ previously developed to the design of a typical carriageway manhole and shows the savings in materials and labour effected in the new design.

WALL DESIGN

It will be of interest to examine the application of the theories described in the previous articles to the design of a common size of carriageway type manhole of interior floor dimensions, 6 ft. by 4 ft. and height 5 ft. 6 ins. (present P.O. type RC1).

It has been shown that the bending moments induced in a slab or a beam depend upon the degree of fixity provided by the supports. It is not possible, therefore, to deduce the stresses in a slab from the loading which is acting upon it without a knowledge of the fixity provided at its edges, which, in turn, depends upon the dimensions, thickness and reinforcement of the adjoining slabs. It is necessary to consider the design of the manhole as a whole, and make preliminary assumptions (which may be subsequently verified) as to the relative thicknesses of concrete and the arrangement of reinforcement in the walls, floor, and roof. It is convenient to assume at first that the thickness of concrete in the different slabs will be the same and that a variation in the density of reinforcement in adjoining slabs will not affect the moment of inertia of the section.

The loadings deduced in Part I, for which a design is required are as follows:—

Vertical loads—

Maximum concentrated single wheel loading (including impact)	11 tons
Maximum distributed loading on roof	3000 lbs./sq. ft.

Horizontal loads—

Maximum concentrated anchor iron loading in end walls	5 tons
Maximum distributed lateral loading on walls	620 lbs./sq. ft. ¹

The effective lengths of the various slabs will be those measured to the centre of the supports. For slab thicknesses of about 6 ins., the effective lengths may be deduced sufficiently closely by adding $\frac{1}{2}$ ft. to the interior dimensions.

Table 1 shows the general method of calculating

¹Part I showed that flooding produced an increase of 125 per cent. in the static earth pressure. The average earth pressure on the walls of a manhole at small depth would be about 200 lbs./sq. ft. (Fig. 8 (c), Part I), and the "flooded" pressure, therefore, $225/100 \times 200 = 450$ lbs./sq. ft. This will be the greatest pressure produced at that depth, since the presence of traffic will, under flooded conditions cause no appreciable increase in the lateral pressure. In the very unlikely event of serious flooding spreading to a depth of 15 ft. or more, it is possible that the external pressure of 620 lbs./sq. ft. may be exceeded, but in such circumstances the manhole would almost certainly have filled quickly with water borne over the ductlines, thereby partly equalising the external pressure and relieving the walls of serious stress.

TABLE I

(1)	(2) "Free" Moments	(3) Corner Moments	(4) Loading
END WALL $\frac{L_y}{L_x} = \frac{6}{4\frac{1}{2}} = 1.33$ $\frac{L_2}{L_1} = \frac{4\frac{1}{2}}{6\frac{1}{2}} = 0.69$	$M = \frac{0.50 \times 620 \times (4\frac{1}{2})^2}{8}$ $= +789$ lbs. ft.	$f_b = -0.41$ $M = 0.41 \times \frac{8}{4} \times 789$ $= -214$ lbs. ft.	EARTH AND TRAFFIC $\omega = 620$ lbs./sq. ft.
	$M = 26\% \times 789$ $= -205$ lbs. ft.	$M = 26\% \times -214$ $= -56$ lbs. ft.	EARTH ONLY $\omega = 160$ lbs./sq. ft. (26% of 620)
	$M = +940$ lbs. ft.	$M = -0.41 \times \frac{8}{4} \times 940$ $= -257$ lbs. ft.	ANCHOR IRON LOADINGS
SIDE WALL $\frac{L_y}{L_x} = \frac{6\frac{1}{2}}{6} = 1.08$ $\frac{L_2}{L_1} = \frac{6\frac{1}{2}}{4\frac{1}{2}} = 1.44$	$M = \frac{0.26 \times 620 \times (6\frac{1}{2})^2}{8}$ $= +855$ lbs. ft.	$f_b = -0.58$ $M = -0.58 \times \frac{8}{4} \times 855$ $= -330$ lbs. ft.	EARTH AND TRAFFIC $\omega = 620$ lbs./sq. ft.
	$M = 26\% \times 855$ $= +222$ lbs. ft.	$M = 26\% \times -330$ $= -86$ lbs. ft.	EARTH ONLY $\omega = 160$ lbs./sq. ft. (26% of 620)
	$M = +120$ lbs. ft.	$M = -0.58 \times \frac{8}{4} \times 120$ $= -46$ lbs. ft.	LOADED CABLE BEARERS (2 concentrated loads of 150 lbs. each)

the "free" and "corner" moments. Column (1) contains the ratios of L_y/L_x , from which the bending moment coefficient can be read from Fig. 7, Part II; the ratio L_2/L_1 is also given and, from Fig. 13, Part II, is used to obtain the value of f_b . The bending moments for the lateral pressures due to earth and traffic loading are evaluated and those due to earth loading only deduced also.

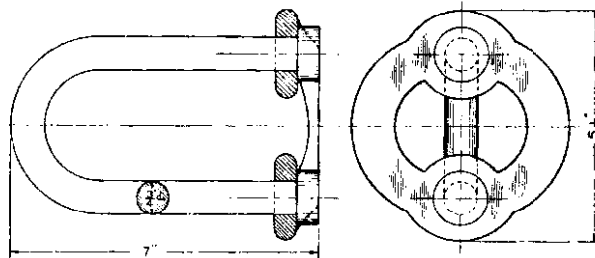

FIG. 1.—ANCHOR IRON.

The bending moments produced by the anchor iron loading on the end wall may be found as follows:—

The redesigned form of anchor iron shown in Fig. 1 has bearing dimensions of approximately 5 ins. \times 5 ins. When embedded in 5-in. concrete with 1 in. cover to the bearing plate, the load spread to the inside wall of the manhole will be given by—

$$u = v = \sqrt{a^2 + H^2} = \sqrt{5^2 + 4^2} = \underline{6.4 \text{ ins.}}$$

Hence $\frac{u}{L_x} = 0.12$ and $\frac{v}{L_y} = 0.089$.

Taking an intermediate value of 0.10 and reading from Fig. 9, Part II, for a ratio of $L_y/L_x=1.33$, $M_x=2.7$, the corresponding value of M_x for a distributed load ($u/L_x=1.0$) is 0.6. The concentrated load, therefore, induces a bending moment in the direction L_x , $2.7/0.6=4.5$ times as great as the same load would, if uniformly distributed. The corresponding distributed load would be $(5 \times 2240)/(6 \times 4\frac{1}{2})=415$ lbs. per sq. ft. The "free" bending moment produced by the concentrated load of 5 tons is, therefore, $4.5 \times 0.5 \times 415 \times (4\frac{1}{2})^2/8=2,350$ lbs. ft. in the direction L_x . This moment is that which would be produced by a loading in the centre of the wall. In the manhole to be designed the anchor irons in the end walls are to be fixed 9 ins. from the side walls and from the roof. It has been explained previously that the method given is applicable only for the calculation of loads disposed symmetrically on the slab. There is no mathematical method, so far as the author is aware, of evaluating the moments where the loads are operating off centre. Tests have shown, however, that, where the load is acting considerably off centre, as in the present instance, a reduction of 60 per cent. in the bending moment may be safely assumed in the direction L_x when the moment to be allowed will be $(40/100) \times 2,350=940$ lbs. ft.

The bending moments in the side wall resulting from loaded cable bearers have been deduced in a

TABLE II—DESIGN MOMENTS

Slab Moment End Wall.

+ 789	} Earth and traffic loading.
- 214	
+ 940	} Anchor iron loading.
- 257	
- 86	Earth loading (side wall).
+ 1,172 lbs. ft.	

5 in. concrete. Reinforcement 0.23 sq. ins./ft.
 $\frac{3}{8}$ in. diam. rods at 6 ins. centres (0.22 sq. ins./ft.).

Slab Moment Side Wall.

+ 855	} Earth and traffic loading.
- 330	
+ 120	} Cable bearer loading.
- 46	
- 56	Earth loading (end wall).
+ 543 lbs. ft.	

5 in. concrete. Reinforcement 0.10 sq. ins./ft.
 $\frac{3}{8}$ in. diam. rod at 12 ins. centres (0.11 sq. ins./ft.).

Corner Moment.

- 214	Earth and traffic loading	} end
- 257	Anchor iron loading	
- 330	Earth and traffic loading	} side
- 46	Anchor iron loading	
- 847 lbs. ft.		

6 in. concrete. Reinforcement 0.13 sq. ins./ft.
 $\frac{3}{8}$ in. diam. rod at 9 ins. centres (0.15 sq. ins./ft.).

similar way by considering the effect of two concentrated loads of 150 lbs. each, calculated as described in Part I.

It is necessary to find from the loadings the maximum positive moments acting on the end and side walls and the corner moments acting at the edge joining them. The greatest positive central bending moment in the end wall will be produced when the 5-ton anchor-iron loading, earth and traffic loading are all acting together. The total moment resulting from these will be the algebraic sum of the free and corner moments produced by these loads as shown in Table II. It will be observed that this moment is diminished by the negative corner moment produced by the earth loading on the side wall. The corner moment at the joining edge and side walls includes all negative corner moments produced simultaneously in the end and side walls. It might be contended that the full traffic loading is not likely to be acting on each wall at the same instant as the maximum anchor iron loading is acting, but any reduction on this account would be uncertain and has not been made.

Arrangement of Wall Reinforcement.

The maximum central positive bending moment of 1,172 lbs. ft. in the end wall requires 5-in. concrete reinforced to a density of 0.23 sq. ins./ft.; $\frac{3}{8}$ in. diam. round rods spaced at 6 ins., giving a density of 0.22 sq. ins./ft., will be suitable. The bending moment in the side wall of +543 lbs. ft. requires reinforcement of 0.10 sq. ins./ft. for 5 in. concrete; $\frac{3}{8}$ in. diam. rods spaced at 12 ins., giving a density of 0.11 sq. ins./ft., will be suitable. (This bending moment could be met by 4-in. concrete, but when the vertical moment in the side wall is calculated it is found that 5-in. concrete is required.) This reinforcement in the end and side walls will be placed on the insides of the walls and, theoretically, need only extend between the points of contraflexure (Part II). For convenience in placing, however, and to take account of bending moments produced from anchor iron loadings in the floor, the vertical bars extend the whole length of the wall and are cranked inwards at their lower ends and set in the floor with normal cover to the surface. By extending these bars sufficiently in the floor of the manhole they may usefully serve also as floor reinforcement, the increased depth of the sump hole being amply strong to accept the induced bending moment without reinforcement. The total vertical loading on the floor of the manhole will be supported, therefore, by the outer area of floor reinforced as described. The density of the reinforcement available by cranking the interior wall reinforcing bars is sufficient for this purpose, since it is not necessary for these bars to accept the stress due to the total traffic load which may occur on the roof of the manhole plus the dead weight of the manhole itself. Only a fraction of this total load will be transmitted to the floor on account of the considerable friction between the rough outside walls of the manhole and the surrounding earth.

The corner moment of -847 lbs. ft. requires reinforcement at 0.16 sq. ins./ft. for 5-in. concrete.

or 0.13 sq. ins./ft. for 6-in. concrete. The corners of the manholes in the present design have been webbed (as shown in Fig. 2) so that a greater thickness of concrete is available at the corners; $\frac{3}{8}$ in. rods spaced at 9 ins. giving a density of 0.15 sq. ins./ft. will be most suitable. The corner reinforcement may conveniently be in the form of rods bent at right angles. The length of each limb will be determined either by the necessity to extend to the point of contraflexure or by the minimum grip length.

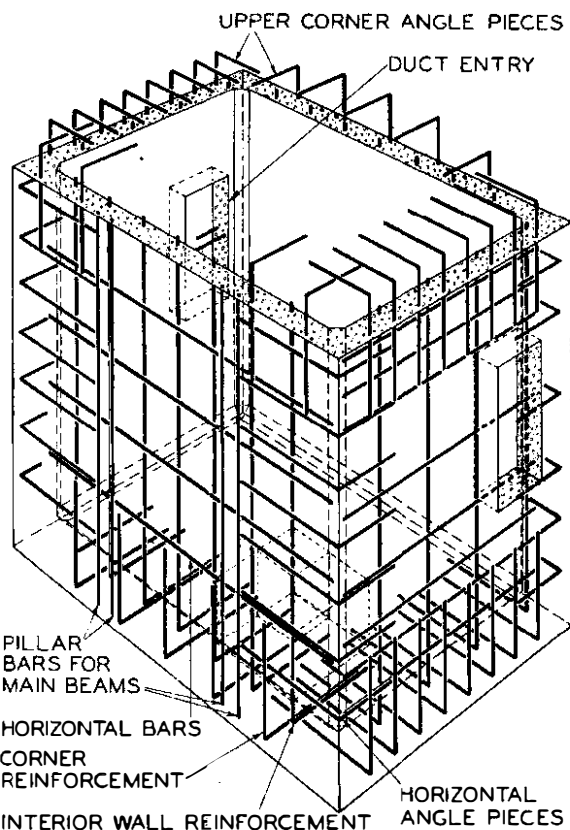
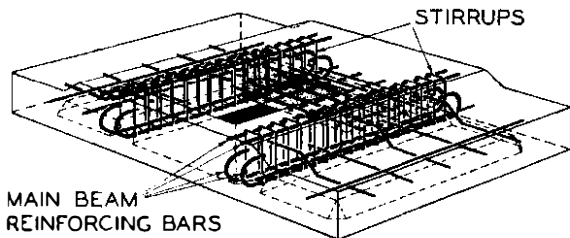

FIG. 2.—MANHOLE TYPE R1.

It is seen in this instance that the end and side walls require to be constructed in 5-in. concrete and, therefore, the assumption that the various slabs will be of equal thickness is correct and no adjustments need be made to the values of f_b , due to a change in the ratio I_1/I_2 . Moreover, the corner moment between the end and side walls is intermediate between the central positive moments in the end and side walls, which allows the most economical construction.

The bending moments in the other directions in

the side and end walls and in the roof slab may be found in a similar way, the beams in the roof slab being considered as providing the same fixity as a vertical wall at that point. The portions of the roof formed between the beams and the end walls require to be reinforced against the negative corner moment at both these points. The ordinary bent corner reinforcement will suffice for corner reinforcement at the end wall.

The calculated values of the negative corner moments at the beams are small and can be met by bending up alternate reinforcing rods as shown.

ROOF DESIGN

The size of manhole under consideration will be fitted with an entrance adjacent to one of the side walls for which the frame and cover supports must withstand the maximum loading of 11 tons.

The load of 11 tons can best be supported by two reinforced concrete beams parallel to the shorter sides of the manhole. It will not be advisable or practicable to assume that these beams are other than simply supported, although they could be made of a smaller section if this were the case. The side walls, unless strengthened, would not be able to provide a satisfactory corner fixity for the localised and considerable bending moment which would be produced in the beams if these were fixed or partially fixed at their ends. Accordingly, the beams have been assumed to be simply supported and, to ensure that the side walls are not subjected to a severe corner moment at the beam supports, pieces of bitumen soaked paper are used to prevent knitting of the concrete at these points. The side walls are, however, reinforced against outward bending at the beam supports by the use of two $\frac{3}{8}$ in. rods placed on the outside, as shown in Fig. 2.

The effective length of the beams will be 4 ft. 6 ins. It is necessary to estimate the proportion of the 11-ton loading which may act on one of the beams. Bearing in mind the width of a cover and the probable bearing area of the wheel concerned, it will be reasonable to allow for a maximum of 60 per cent. of the total load to act on either either beam. This load will be distributed throughout the length of $2\frac{1}{2}$ ft. from one end.

The bending moment produced will be, therefore :—

$$\frac{60}{100} \cdot 11 \cdot \frac{3\frac{1}{2}}{4\frac{1}{2}} \left(\frac{2\frac{1}{2} \cdot 3\frac{1}{4}}{2 \cdot 4\frac{1}{2}} \right) = 4.3 \text{ ft. tons} \\ \text{or } 9,650 \text{ ft. lbs.}$$

(The moment due to the dead weight of the beam, frame and cover is very small and may be safely neglected.)

A convenient size of beam which will accept this moment will be 6 ins. wide and 10 ins. deep reinforced in full compression with four $\frac{3}{4}$ in. diam. rods. Allowing for 1 in. cover to the rods, the bending moment which this beam can accept will be (Fig. 3(b), Part II), $2 \times 18,000 \times 0.88 \times \frac{3\frac{1}{2}}{12} = 9,600$ ft. lbs., which is satisfactory. The minimum grip length for a $\frac{3}{4}$ in. rod is $37\frac{1}{2} \times \frac{3}{4}$ (Equation (10), Part II) = 28 ins., i.e. 2 ft. 4 ins. This is very close to the half-length of the reinforcing rod in the beam and the resulting bond stress will be satisfactory. An end anchorage consisting of a hook of the prescribed dimensions is also incorporated.

Shear Reinforcement.

The greatest shear force will operate when the load of 60 per cent. of 11 tons, i.e. 6.6 tons, is transmitted to one beam and is of magnitude $6.6 \times 3\frac{1}{4} / 4\frac{1}{2} = 4.7$ tons at the support nearest to the cover.

If unreinforced, the shear stress in the concrete would be $(4.7 \times 2240) / (10 \times 6) = 175$ lbs./sq.in. This stress exceeds the safe shear stress for concrete and necessitates shear reinforcement. Equation 8, Part II, shows that $\frac{3}{8}$ in. diam. stirrups spaced at 3 ins. centres will accept a shear force of $2 \times 7\frac{1}{2} / 3 \times 18,000 \times 0.11 = 9,500$ lbs. = 4.3 tons. This value, although a little below that required, will be satisfactory, since the concrete itself can accept the remaining force.

The undersides of the beams are chamfered at their lower edges, which makes them less obstructive and reduces considerably any tendency for the concrete to chip off and expose the steel reinforcement to rust.

The general arrangement of shear reinforcement is shown in Fig. 2.

MANHOLE CONSTRUCTION

Although it may appear that the arrangement of reinforcement is complicated it should be stated at once that completion of the manhole is not made more tedious or costly in labour on this account. This is partly due to the number of items of reinforcement involved being only slightly greater than with earlier designs and to the fact that the placing of reinforcing material occupies only a very little time in comparison with the total time taken to build the manhole. For convenience and accuracy in construction, the reinforcing material for each manhole is delivered to the site already cut, bent and labelled. A complete set of reinforcing material for a type R0 manhole is

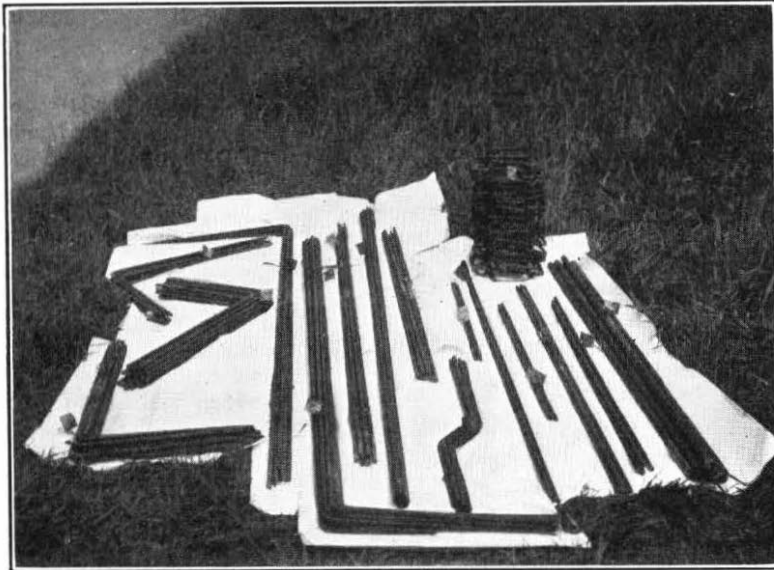

FIG. 3.—REINFORCING MATERIAL FOR MANHOLE TYPE R0.

shown in Fig. 3. A marked advantage of the new design is in the use of a spacing of 9 ins. instead of 4 ins. for the vertical interior wall reinforcement. This wider spacing permits the end and side walls

to be built up more readily from inside the manhole and allows filling and tamping of the walls to be carried out much more quickly. The method of construction which has been found most satisfactory is as follows: After the excavation has been completed, concrete is laid on the foundation to a thickness of $1\frac{1}{2}$ ins. With the aid of a light and simple wooden template erected about 1 ft. 6 ins. above the foundation, the corner reinforcement for the side and end walls may be placed so that the portion of the bars in the floor is just covered by the concrete and they protrude vertically so as to give $\frac{3}{4}$ in. cover at the end and side walls when these are erected (Fig. 4). Additional concrete may then be laid up

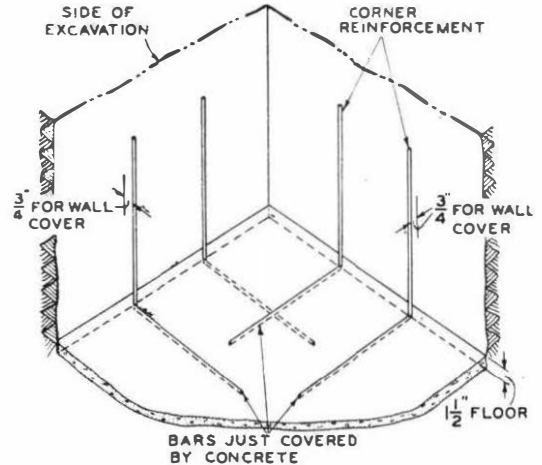

FIG. 4.—CORNER REINFORCEMENT FOR SIDE AND END WALLS.

to the required level for the floor, and the long cranked bars for interior wall reinforcement and also the side wall pillar bars placed, these being steadied at their upper ends by temporarily binding them to a horizontal rod. The template is best cut in grooves in preference to being drilled where rods are to be fitted, since this allows the template to be twisted and withdrawn instead of requiring to be lifted clear of all bars.

When the floor has been left for twelve hours, the shuttering for the wall may be erected and the horizontal bars and wall-to-wall corner reinforcement placed as the walls are built up. It is unnecessary to wire up this reinforcement, since there is no tendency for the reinforcement to move when once placed.

When the walls have been built to the requisite height, the roof shuttering is set up and a 1 in. thickness of concrete may be laid throughout the roof area including the beams. The beam reinforcement may then be laid at one movement, the stirrups having been threaded and wired to the rods before-

hand. The 1 in. cover to the main beam reinforcing rods is given readily, since the weight of the assembly is such as to permit the stirrup ends to sink into the concrete, but not to allow the larger surface of the main reinforcement to do so. The remainder of the roof reinforcement may now be laid and, to give the correct cover (of $\frac{3}{4}$ in.) the rods should just protrude above the surface of the concrete. The bent bars may be conveniently supported by a single wired fixing at the point where they enter the beam reinforcement. The concrete in the roof is then made up to the necessary thickness and finally the roof-to-wall corner reinforcement added. The correct cover of $\frac{3}{4}$ in. to the top of the roof can be checked by a wood spike and, when correct at each end of the horizontal part of the rod, ensures that the vertical portion has the correct cover throughout its length. It is unnecessary to shutter the upper side of the beams, and these are spade finished to a convenient slope as shown in Fig. 5. A single course of $4\frac{1}{2}$ -in. brickwork is used to support the frame and cover as in normal practice.

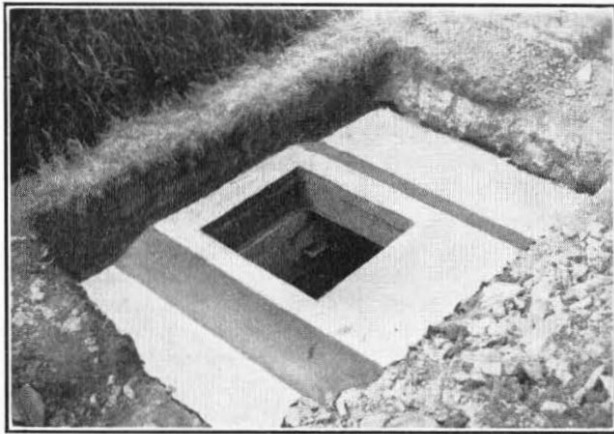

FIG. 5.—ROOF TOP SHOWING SPADE FINISH.

Application of Design to various sizes of Manholes.

Although the details of reinforcement and the method of construction outlined relate to the construction of a common size of manhole (the R1), the principles explained are equally applicable to smaller and larger types.

A slight additional economy in steel has been made in the larger types by grading the density of reinforcement in accordance with the changing bending moment. Thus, in some instances, an increase in the spacing of the reinforcing bars has been made towards the edges of the slabs where the bending moments are, of course, less than at the centre.

A departure from the type of roof construction incorporating double beams described in connection with the manhole R1, requires to be made in the largest type of carriageway manhole for, in this instance, the dimensions of the roof slab would, if supported by two beams at the frame and cover only, require to be prohibitively deep. Two additional beams have, therefore, been employed across the

short spans for dividing up the roof into four smaller slabs.

FOOTWAY TYPE MANHOLES

The design of footway manholes is basically the same as for the corresponding carriageway types in so far as the combined lateral earth and traffic loadings for which they must be designed are identical. The maximum concentrated load which the frame and cover are required to accept, however, is much smaller and, in practice, is governed by the weight of the heaviest cable drum which is likely to be rolled over the roof. The maximum concentrated load to which footway manholes are likely to be subjected is 4 tons. This load exceeds the weight of the majority of loaded cable drums in use, but is less than that for exceptionally heavy drums which may approach 6 tons in weight. Such heavy drums, however, even when rolled on their battens over the roof of a footway manhole would be unlikely to produce a greater concentrated loading than approximately 4 tons on the cover, frame and to the beams, since even with a slightly convex cover, the batten in contact with the ground would certainly bend and crack thereby dispersing the load and producing two loads which would probably be acting off the cover on the surrounding ground, neither exceeding 3 tons. On this basis the design of the footway manholes is such that up to depths of 5 ft. an economy in construction can be made by dispensing with beams; beyond this depth, reinforced concrete beams are necessary for the support of the frame and cover, and there would be no advantage in departing from the carriageway type of roof construction as already designed.

The general design of footway manholes, therefore, on this basis would be applicable for depths up to 5 ft. for which the roof slabs are designed without beams, i.e. as flat slabs (except in the largest manhole. Examination of the various stresses produced in the walls of footway manholes designed

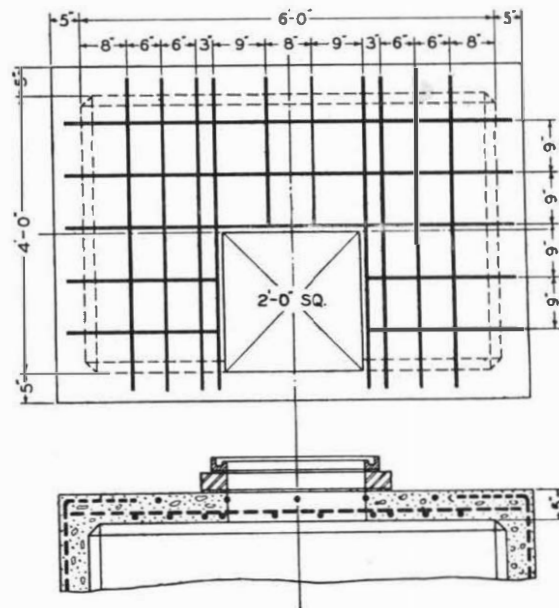

FIG. 6.—ROOF DESIGN FOR FOOTWAY MANHOLE.

in this way shows that, although the degree of fixity of the walls at their upper end is changed, the bending moments in the walls are sensibly the same as for the corresponding types of carriageway manholes, which conveniently allows of the same density and arrangement of reinforcement in the walls and floor. Footway manholes, therefore, designed in this way would depart from the corresponding carriageway types only in so far as they would vary in roof construction, in dispensing with beams and in the adoption of a simple slab reinforcement.

A roof design for a footway manhole is shown in Fig. 6.

There is, however, only a very small saving in labour and material in this construction compared with the carriageway design and, in view of the possibility of footway type manholes requiring to be converted to carriageway type on account of road widenings or for other reasons, it has been decided to standardise the carriageway type construction for use in both footways and carriageways. The manholes, which will be known as R0, R1, etc., will, therefore, be suitable for construction in carriageways and footways alike at all depths, the frame and cover being of carriageway or footway type as appropriate.

By this reduction in the number of types of manholes it is expected to simplify construction and the preparation of estimates and to avoid the demolition of footway type manholes when it is found that carriageway types are required.

SHAFTS

The theory outlined can readily be applied to calculate the necessary thickness of concrete and reinforcement for manhole shafts. Fig. 8, Part I, shows that the maximum horizontal pressure due to earth and traffic loading is approximately 1,100 lbs./sq. ft. Assuming that the effective length of the slab span of a side of the shaft is $2\frac{1}{2}$ ft. and that the span is long in comparison with its width, the "free" moment produced across the span would be $1100 \times (2\frac{1}{2})^2 / 8 = 860$ lbs. ft. For a square shaft the ratio $L_2/L_1 = 1$, and the value of $f_b = 0.5$ (Fig. 13, Part II). The corner moment will be $-0.5 \times \frac{2}{3} \times 860 = -286$ lbs. ft., and the central positive moment is, therefore, $860 - 286 = +574$ lbs. ft.

This moment could be met by 4-in. concrete, but it will be more satisfactory to use 5-in. concrete on account of it being desirable to work to a higher factor of safety in the shaft where bulging of the concrete might have serious consequences. Further, there is some risk of the percolation of water if a thickness of concrete much less than 5 ins. is used.

Suitable reinforcement would, on this basis, be $\frac{3}{8}$ in. dia. rods at 6-in. spacing for the central positive moment, and $\frac{3}{8}$ in. dia. rods at 9-in. spacing for the corner reinforcement, the general arrangement being as in Fig. 7.

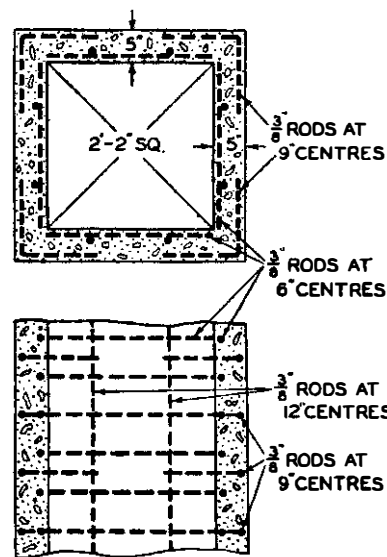

FIG. 7.—REINFORCEMENT OF TYPICAL MANHOLE SHAFT.

ECONOMIES EFFECTED IN STEEL AND CONCRETE

The savings in materials effected in the designs described vary in the different sizes of manholes. The amount of steel used in the new design is approximately 40-50 per cent. of that used in the early designs and the corresponding amount of concrete between 75 and 80 per cent. Due to the reduced thickness of the walls there is also a slight saving in excavation charges. As has been previously mentioned, the wider spacing of the reinforcement in the walls enables these to be erected more quickly and, despite the increased complication of the reinforcement, there is an appreciable saving in the time necessary to erect the walls.

Experience so far has been confined to the building of one or two manholes of each type, and circumstances did not permit an accurate record of costs to be kept during construction. It is expected, however, that the overall cost of the re-designed manholes will show a reduction of between 10 and 15 per cent., this saving, as explained, being partly due to the conservation of steel and concrete, and partly to the reduction in labour both in laying concrete and in excavation charges.

A Simple Introduction to the Use of Statistics in Telecommunications Engineering

U.D.C. 519.2 : 621.39

J. F. DOUST and
H. J. JOSEPHS, F.S.S., A.M.I.E.E.

Part 3.—The Poisson Probability Law

The present article discusses the fundamental principles of probability theory from the viewpoint of the Poisson probability law. A significance test is outlined.

Introduction.

THE previous articles of this series dealt with normal distributions in which it was theoretically possible for a member of a population to possess any value within a certain range. Many important cases arise, however, where this is not possible and only certain values, say positive integers, can occur. The Normal Probability Law no longer applies and in the following pages other methods of attack, based on the Poisson Probability Law, are outlined. Owing to the gradual merging of one type of distribution into another it will be seen that alternative methods are available, and the choice of the most suitable becomes a matter of experience.

The dependence of the theory of statistics on the classical theory of probability can no longer be ignored, but is hoped that, as before, most difficulties have been avoided by a liberal use of the phrase "It can be shown . . ."

Continuous and Discontinuous Variables.

It is well known that the theory of probabilities lends itself to the solution of many important telephone problems. These problems arise not only in connection with the trunking of calls but also in statistical studies which underlie the making of fundamental plans. The variables considered may be divided into two main classes—"continuous" and "discontinuous." A variable which is able to take all possible values between given limits is regarded as "continuous" over the range considered. When a variable is not able to take all possible values within a given range, but is confined to a particular series of values, such as the whole numbers, it is said to be "discontinuous."

The normal probability distribution is the most important of the continuous distributions; but among discontinuous distributions the Poisson probability distribution¹ is of the first importance. If a variable can take the values 0, 1, 2, 3, 4, . . . , and the relative frequency (or probability) with which these values occur is given by successive terms in the sequence

$$e^{-m}, me^{-m}, \frac{m^2}{2 \times 1} \cdot e^{-m}, \frac{m^3}{3 \times 2 \times 1} \cdot e^{-m} \dots$$

where m is the arithmetic mean of the values, then the variable is distributed according to the Poisson probability law. The terms in the sequence represent the relative frequency of occurrence of the values 0, 1, 2, 3 It will be recalled that relative frequency of occurrence is defined by the ratio f/N , where f is the frequency with which the event occurs and N is the total number of observa-

tions. It will be noted that whereas the normal probability law has two unknown parameters, the mean M and the standard deviation σ , the Poisson probability law has only one, namely, the mean m . The Poisson probability law is sometimes called "the law of small probabilities" for reasons stated in Appendix I, where it is shown rigorously that p_r , the probability (f/N) that an event will happen exactly r times in a large group of trials for which the average number is m , is given by the expression

$$p_r = \frac{m^r}{r!} e^{-m} \dots \dots \dots (1)$$

where $r!$ stands for "factorial" = $r(r-1)(r-2) \dots 3 \cdot 2 \cdot 1$.

As an example of the Poisson law of small probabilities, consider the chance of obtaining a given number of lockouts² on a 4-wire telephone circuit equipped with two echo-suppressors.

Suppose that during the testing of a certain 4-wire circuit, records³ were made of the number of lockouts occurring in 50 telephone conversations and that it is desired to see if the observed frequency of lockout is in accordance with the Poisson law of small probabilities. Suppose also that each conversation was arranged to have an approximate duration of 100 seconds and the observed lockouts were distributed as shown in Table I.

TABLE I

Lockouts per conversation	0	1	2	3	4
Observed frequency	22	18	7	2	1
Calculated frequency	21.6	18.2	7.7	2.1	0.4

To see whether the observed frequencies vary according to a Poisson law the value of m must first be estimated from the sample. It is found to be 0.84. The value of $e^{-0.84}$ is 0.4317. Reverting to equation (1) and recalling that p_r is f_r/N , where N is now 50, the Poisson frequency for no lockouts is,

$$f_0 = 50e^{-0.84}, \text{ or approximately } 21.6.$$

Likewise the frequency for one lockout is,

$$f_1 = 50 (0.84) e^{-0.84}, \text{ or approximately } 18.2.$$

In a similar manner f_2, f_3 and f_4 can be easily calculated from equation (1). The closeness of fit between the observed frequencies and the calculated Poisson frequencies is shown in Table I.

When it is recalled that several variables can affect the frequency of lockout and that the value of

¹Poisson, *Recherches sur la Probabilité des Jugements*, Paris, 1837, pp. 205.

²*B.S.T.J.*, April, 1938, Vol. XVII, p. 258.
³*B.S.T.J.*, April, 1938, Vol. XVII, p. 281.

the parameter m has been estimated from a small sample, the question of the stability of this sample becomes of importance. In other words, are the discrepancies between the observed and calculated frequencies due to the vagaries of random sampling, or, are they due to the fact that the observed frequencies do not follow a Poisson probability law? This question will be answered later in the article. At this stage, however, before any significance test has been applied to the data, it is important to treat any inference concerning the frequency of lockouts as tentative.

It is shown in Appendix 1 that the Poisson distribution is soundly based on simple probability theory and also that it consists of a series of discrete points corresponding to integral values of r . That the Poisson distribution must be a series of discrete points and not a continuous curve is a direct result of the assumption that r represents a number of occurrences, and it is important to note that the distribution is determined solely by the value of the arithmetic mean m . The Poisson distributions for several values of the mean, m , are shown in Fig. 1. The smooth continuous curves have been drawn through the discrete points which represent the distribution merely to show more clearly the form of the distribution.

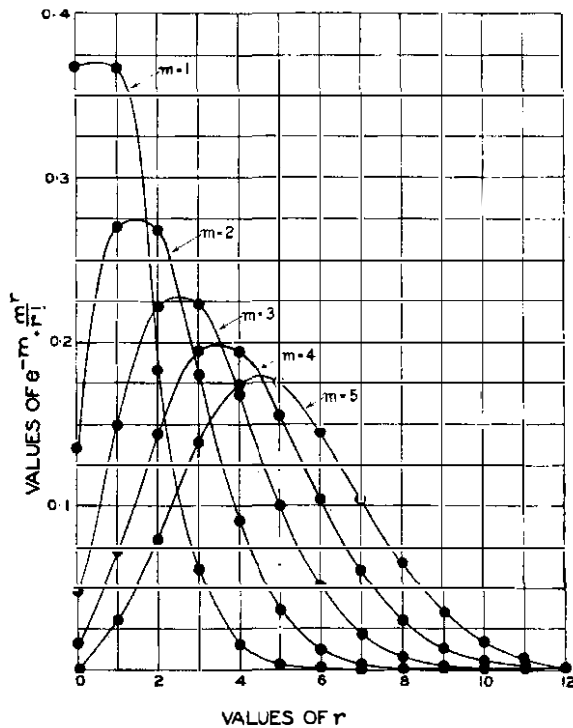

FIG. 1.—POISSON DISTRIBUTION FOR VARIOUS VALUES OF THE MEAN.

It can be seen from Fig. 1 that the skewness of the Poisson distribution is very large for distributions which have small values of m and is less in those with larger values of m . The Poisson distribution tends to approach that of the normal law as m increases and would eventually become identical with the

normal law if m became infinite. Since, however, m must always remain finite, the distribution can never reach exact equivalence to the normal distribution, although for large values of m the difference between the two distributions is extremely small. The characteristics of the distribution are simple in that, although skew, they are completely determined by one parameter alone, namely, the arithmetic mean m . It will be shown later that this fact makes it possible for the engineer to devise a straightforward graphical test to determine the stability of a Poisson distribution while data are actually being gathered.

The Poisson Exponential Summation.

According to the Poisson distribution the probabilities of occurrence of the values 0, 1, 2, 3, . . . etc. are given by the series,

$$e^{-m} \left(1, m, \frac{m^2}{2!}, \frac{m^3}{3!}, \dots, \frac{m^r}{r!}, \dots \right)$$

where m is the arithmetic mean. Thus, according to this series, the chance that there are exactly 3 occurrences of an event in a large group of trials is given by $(m^3 e^{-3})/3!$. The chance that there will be at least 3 occurrences in the group will be given by the sum of the series, starting at 3, namely,

$$e^{-m} \left(\frac{m^3}{3!} + \frac{m^4}{4!} + \frac{m^5}{5!} + \dots + \frac{m^r}{r!} + \dots \right)$$

In general, the chance or probability P_r that an event will happen at least r times in a large group of trials, may be written as,

$$e^{-m} \left(\frac{m^r}{r!} + \frac{m^{(r+1)}}{(r+1)!} + \frac{m^{(r+2)}}{(r+2)!} + \dots \text{etc.} \right)$$

because it is the sum of the probabilities of the occurrence of all values equal to or greater than r . This expression can be written as

$$P_r = e^{-m} \sum_{n=r}^{\infty} \frac{m^n}{n!}$$

where the summation sign Σ indicates that the sum of all the terms from r to ∞ , beginning with $m^r/r!$, is to be taken. This series is known as Poisson's exponential summation and is one of the fundamental expressions in modern probability theory. For purposes of calculation, however, it is possible to transform P_r (which involves an infinite limit in the summation), into a more convenient form.

Noting that $e^{-m} \sum_{n=0}^{\infty} \frac{m^n}{n!}$, the sum of all possible

chances, is equal to unity, P_r may be written in the finite form

$$P_r = 1 - e^{-m} \sum_{n=0}^{r-1} \frac{m^n}{n!} \dots \dots \dots (2)$$

which is quite convenient for numerical calculation.

In engineering applications of Poisson's law the summation form is generally used instead of the

individual term form, because usually the chance of exceeding a certain limit, rather than the chance of obtaining any one particular value, is required.

It has been found⁴ that the rapid application of the Poisson summation to practical problems is greatly facilitated by the use of what may be described as Poisson probability paper. In Fig. 2 are sets of curves, calculated from statistical tables⁴, showing Poisson's exponential summation expressed by equation (2).

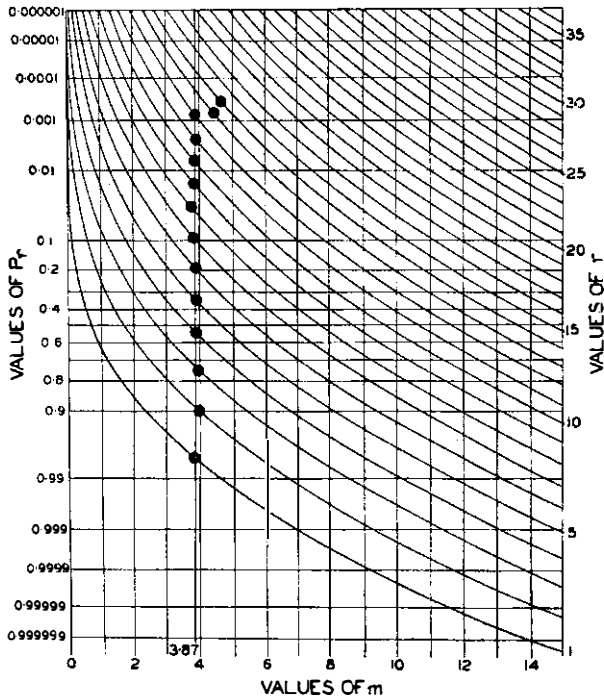

FIG. 2.—COMPARISON OF AN OBSERVED DISTRIBUTION OF RELAY CONTACT FAULTS WITH ITS CORRESPONDING THEORETICAL POISSON DISTRIBUTION.

The curves in Fig. 2 give the relationship between m , the mean number of occurrences of an event in a large group of trials, and the probability P_r that the actual number of occurrences in any such group of trials will equal or exceed any given number r . A scale proportional to the normal probability integral and constructed in the manner outlined in the first article is used for P_r . A linear scale is used for the mean m , and the curves indicate particular values of r starting at $r=1$. One chart (see Fig. 4) covers a wide range of values of m and r , the individual r curves extending from $m=0$ to $m=200$ in steps of 5. To cover on a larger scale a smaller range of m and r values, the probability chart shown in Fig. 2 has been produced, which gives the individual r curves in unit steps from $m=0$ to $m=15$. These two probability charts⁴ were prepared by Dr. G. A. Campbell, and a third chart, supplementary to the above two, has been prepared by Miss F. Thorndike.⁵ This has a logarithmic scale for m , and shows more

clearly than the Campbell charts, the important range $0.1 \leq m \leq 2$. These probability charts enable the comparison of actual data with the corresponding Poisson summation to be easily made graphically, thereby avoiding tedious calculations. The charts can be used as co-ordinate paper⁶ on which to plot any distribution of data, theoretical or observed, provided the values of the variable are limited to the positive integers and zero.

The Use of Poisson Probability Paper.

In the vast majority of practical uses the engineer will know whether or not he is dealing with a discontinuous variable. If observations are made of the occurrence of a discrete event which either definitely happens or fails to happen, it is likely that the frequency distribution will be of the Poisson type. As an example consider the occurrence of faults on a particular type of relay contact in automatic exchanges as shown in Table II.

TABLE II

Number of contact faults per exchange per week . .	0	1	2	3	4	5	6	7	8	9	10	11	12	13	14
Observed frequency . .	57	203	383	525	532	408	273	139	45	27	10	4	0	1	1
Calculated frequency . .	54	210	407	525	508	394	254	140	68	29	11	4	1	0	0

From the nature of the event under observation it may be assumed that the observed frequency distribution will follow a Poisson probability law. To test this assumption the theoretical frequencies are calculated and compared with the observed frequencies. The mean m of the observation is 3.87, and using this value in equation (1) the theoretical frequencies can be calculated. From the table it can be seen that the calculated frequencies fit the observed frequencies reasonably closely.

For the purpose of testing the goodness of fit it is desirable to plot both the theoretical and observed frequencies on Poisson probability paper. Since r is small and $m=3.87$, the second type of Poisson probability chart is used in which the individual r curves extend in unit steps from $m=0$ to $m=15$. To use this chart as a background for plotting the observed frequency distribution begin by erecting a vertical line at the point $m=3.87$. The corresponding theoretical Poisson distribution is represented by the points in which the vertical line cuts the r curves, or for convenience, simply by the vertical line itself as shown in Fig. 2. The observed distribution may then be plotted with r and P_r as the independent variables, and the horizontal deviations of these points from the vertical line serve as a measure of the discrepancy between the two distributions. Since a goodness of fit test is to be made between a theoretical and an observed frequency distribution, the values for the probability P_r are the values of the observed relative frequencies, and these can be calculated from the observed data as shown in Table III.

⁴B.S.T.J., Jan., 1923, Vol. II, p. 95.
⁵B.S.T.J., Oct., 1926, Vol. V, p. 604.

⁶The three classes of Poisson probability paper discussed in this article can be obtained from the Research Branch of the E-in-C's Office.

TABLE III.—ARRANGEMENT OF DATA FOR A POISSON TEST

Number of contact faults per exchange per week	Observed frequency of occurrence	Number with at least the values of 0, 1, 2, . . . etc.	Relative frequency (P _r)
0	57	2608	1.0000
1	203	2551	.978
2	383	2348	.900
3	525	1955	.753
4	532	1440	.552
5	408	908	.348
6	273	500	.192
7	139	227	.087
8	45	88	.034
9	27	43	.0165
10	10	16	.0061
11	4	6	.0023
12	0	2	.00077
13	1	2	.00077
14	1	1	.00038

Sum of frequencies } = 2608

It can be seen from Fig. 2 that there is a good fit between the observed dots and the vertical line and consequently it may be concluded that the sample examined indicates that the number of contact faults follows a Poisson probability law.

A Poisson Significance Test.

It is necessary to bear in mind several practical conditions which must work against any perfect agreement between an observed distribution and the corresponding Poisson distribution. In the first place, the sample considered will necessarily consist

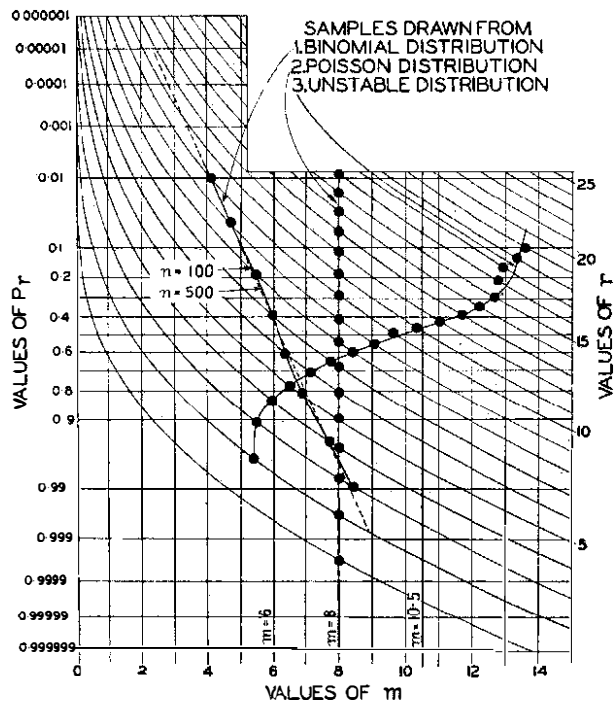

FIG. 3.—A POISSON TEST FOR STABILITY OF MEAN.

of a finite number N of items instead of an infinite number as assumed in the mathematical theory, and in the second place, the items considered may not be completely independent as assumed in the theory.

In a stable Poisson sample the horizontal deviations from the vertical line erected at its mean value m, should be very small, whereas if the number of items N is too small to ensure stability, the plotted points will fall about a vertical line to the left or right of m, the distance being reduced as the number of items in the sample is increased. If, however, the mean of the population is unstable or varying in any manner, the plotted points will slope to the right as shown in Fig. 3, curve 3. If a random sample has been drawn from a stable population, but not a Poisson population, its distribution of dots will be away from the Poisson vertical line and sloping to the left.

The Binomial Probability Law.

In the Appendix it is shown that if the probability of an event occurring is p, and the probability of it not occurring is q, then if a random sample of n trials is made, the frequencies with which the event occurs 0, 1, 2, 3 . . . n times are given by the successive terms of the binomial expansion (q+p)ⁿ. The binomial probability law is one of the fundamentals of probability theory and it can be shown that most of the stable distributions of discrete points, including the Poisson distribution can be derived from the binomial (q+p)ⁿ.

When p=q and n ≥ 10, the binomial distribution reduces to the normal probability distribution. If, however, n > 1000 and p ≠ q, but neither is very small, the binomial distribution again reduces to the normal form. The plotted points in Fig. 3, curve 1, were obtained from random samples drawn from a normal population according to the binomial (½+½)¹⁰. It should be noted that the negative slope is only slightly affected by the number of items in the sample. It is shown in Appendix 1 that a special case arises when p → 0 as n → ∞ in such a way that the product np remains finite and equal to the mean m for (q+p)ⁿ then reduces to the Poisson exponential series given by equation (1).

The Theory of Probability.

The theory of statistics is derived from the classical theory of probability which developed in France from a study of lotteries and games of chance. Before discussing the meaning of probability in statistics it would be well to point out that the word "probability" is used in two senses: in ordinary life it refers to the degree of uncertainty that is felt about the occurrence of an event; in mathematics it refers to a number. This number is a measure of the probability and falls in the range between zero and unity. The end points 0 and 1 correspond to "impossibility" and "certainty" respectively. The twin meaning of the word probability, its reference to the state of ignorance concerning an event and its measurement relative to an arbitrary scale, are obviously joined together. Otherwise the results of mathematical investigation could never be applied to everyday life. Whatever this bond may be, it

belongs to the realm of philosophy. In these articles it is only the numerical aspect of probability that is under review and not the abstract conception itself.

The classical theory of probability splits into two main divisions, the *a priori* and the *a posteriori*. In *a priori* probability a population with known characteristics is given and a probability question is asked regarding a sample which is to be taken from the population. For example, a box contains 1,000 rectifiers of which 50 are defective. If 100 of them are selected at random what is the probability that, say, 10 of the 100 selected will be defective? In *a posteriori* probability the characteristics are given of a sample which has been taken from an unknown population and a probability question is asked regarding the unknown sampled population. For example, suppose that a box contains 1,000 rectifiers, of which some unknown number are defective. Of 100 rectifiers selected at random from the box, 10 are defective. What is the probability that, say, 50 of the 1,000 rectifiers are defective?

The Solution of an *a priori* Probability Problem.

So far only the solution of statistical or *a posteriori* probability problems has been dealt with. It must not be thought, however, that the application of probability paper is restricted to this class of problem. As an example of the solution of an *a priori* probability problem consider the following question: How many junction lines to a nearby exchange shall be installed from an exchange of 2,000 subscribers so that only one out of every hundred calls between the two exchanges fails to find immediately an idle junction line? To answer this question it is assumed that during the busy hour of the day each of the 2,000 subscribers makes a call to the nearby exchange. Suppose that when a call has been established between the two exchanges the conversation lasts on an average for exactly two minutes. Since two minutes is 1/30th of an hour, it is anticipated that on the average 1/30th of 2,000, or approximately 67 simultaneous calls must be provided for. This is the value of m to use in the Poisson formula. But what about deviations from the mean m ? What are the probabilities that this mean will be exceeded to various extents? To determine these probabilities by plotting on Poisson probability paper, let the horizontal m scale represent the average number of simultaneous calls from the subscribers, and the vertical P_r scale the probability that all the junction lines will be in use when a subscriber attempts to make a call; the number of junction lines is represented by the r curves. Then draw a vertical line at $m=67$ on the Poisson probability paper as shown in Fig. 4. The Poisson distribution of the problem is then represented by the points in which the vertical line erected on the calculated m value cuts the r curves, or for convenience, simply by the vertical line itself.

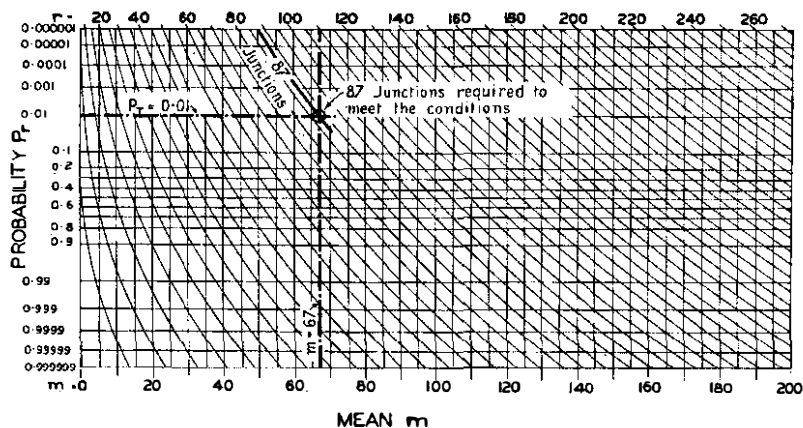

FIG. 4.—APPLICATION OF POISSON PROBABILITY PAPER TO A SIMPLE *a priori* TRUNKING PROBLEM.

To determine the number of junction lines required to meet the 1 in 100 condition, draw a horizontal line from $P_r=0.01$ to cut the vertical line at $m=67$. At the point of intersection of the two lines the value of r , the number of junction lines required to meet the 1 in 100 condition, is found to be 87. Thus 87 junction lines must be installed when the average number of simultaneous conversations expected is 67. The probabilities that the average will be exceeded to various extents can be easily read from the curve. Thus the probability that the average will be exceeded by 13 (i.e., there will be $67+13=80$ simultaneous conversations) is found to be 0.07 by drawing a horizontal line on to the P_r scale from the point of intersection of the r curve marked 80 with the vertical line at $m=67$. From the Poisson probability curves Table IV below can be readily constructed.

TABLE IV

(1) Deviations from the mean	Probability that number will be at least that specified in column (1)
$65=67-2$	0.6
$67=\text{mean}$	0.5
$69=67+2$	0.4
$80=67+13$	0.07
$87=67+20$	0.01
$106=67+39$	0.000006

This example shows that the Poisson probability paper can be used in the solution of *a priori* probability problems and can also be used conveniently in place of unwieldy double-entry statistical tables to obtain the values needed for making trunking studies.

Other Applications of Poisson Probability Paper.

In this article only a few of the possible applications of Poisson probability paper have been mentioned. It has been shown recently⁷ that Poisson probability paper can be used on problems which arise in the building-up of any kind of apparatus out of a large number of separate parts. To ensure that a particular piece of apparatus will function within prescribed limits when it is built up of piece-parts selected at random, it is necessary to control the chance variations of each of the parts, so that the resultant chance variation in the quality of the assembled unit will fall within the defined limits with a given degree of confidence. Poisson probability paper can thus be used in the determination of the cost of reducing the overall chance fluctuation by modifying the chance variations of the various piece-parts, and so help to ensure an economic control of quality of manufacture. The importance of this control is apparent when it is recalled that over 200 piece-parts are required to make a telephone and over 110,000 other parts may be involved in its connection to another telephone. The annual production of most of these piece-parts runs into the millions, so that the total annual production of parts runs into the billions.

APPENDIX.

Consider the problem of the occurrence of an event in n trials. Let p_1 be the probability of the happening of the event in one trial. Then the probability that the event will happen in each of the first r trials and fail in each of the remaining $(n-r)$ trials is $p_1^r(1-p_1)^{n-r}$. But the number of ways in which the event may happen exactly r times in n trials is equal to C_r^n . Hence the probability p_r that the event will happen exactly r times in n trials is—

$$p_r = C_r^n p_1^r (1 - p_1)^{n-r} \dots\dots\dots (1)$$

put $m = np_1$
then

$$\begin{aligned} p_r &= C_r^n \left(\frac{m}{n}\right)^r \left(1 - \frac{m}{n}\right)^{n-r} \\ &= \frac{n!}{r!(n-r)!} \left(\frac{m}{n}\right)^r \left(1 - \frac{m}{n}\right)^{n-r} \\ &= \frac{n(n-1)(n-2)\dots(n-r+1)}{r!} \cdot \frac{m^r}{n^r} \cdot \left(1 - \frac{m}{n}\right)^{n-r} \\ &= \frac{m^r}{r!} \left(1 - \frac{1}{n}\right) \left(1 - \frac{2}{n}\right) \dots \left(1 - \frac{r-1}{n}\right) \left(1 - \frac{m}{n}\right)^{n-r} \end{aligned}$$

If n gets very large, then, $\left(1 + \frac{m}{n}\right)^{n-r} \rightarrow e^{-m}$

$$\begin{aligned} \therefore p_r &= \frac{e^{-m} m^r}{r!} \left(1 - \frac{1}{n}\right) \left(1 - \frac{2}{n}\right) \dots \left(1 - \frac{r-1}{n}\right) \\ &= \frac{e^{-m} m^r}{r!} \left\{ 1 - \frac{1+2+\dots+(r-1)}{n} + \dots \right\} \\ &= \frac{e^{-m} m^r}{r!} \left\{ 1 - \frac{r(r-1)}{2n} + \dots \right\} \end{aligned}$$

Since n is large compared to r , then

$$p_r = e^{-m} \frac{m^r}{r!} \dots\dots\dots (A)$$

which had to be proved.

It will be noted that equation (1) is the r th term in the expansion of $(q+p)^n$ where $q=1-p$.

Thus if p denotes the probability of the happening of a certain event in one trial and q is the probability of its failure in one trial, then $p+q=1$, and the probabilities of 0, 1, 2, 3, . . . n , occurrences of the event in n trials, are given by the successive terms of the point binomial $(q+p)^n$.

Although the calculations involved in the application of the point binomial when n is large are not difficult they may take a considerable time to complete. In this connection it is interesting to note the several close approximations to the binomial law when n is large.

(1) . . . If $n \rightarrow \infty$, then $(q+p)^n \rightarrow \frac{1}{\sigma\sqrt{2\pi}} e^{-\frac{(x-ny)^2}{2\sigma^2}} = y_1$

where y_1 is the normal probability equation discussed in the first article.

(2) . . . If $p=q=\frac{1}{2}$, then $(q+p)^n \rightarrow y_1$ if $n \geq 10$.

(3) . . . If $p \neq q$, but neither is very small, then $(q+p)^n \rightarrow y_1$ if $n \geq 1,000$.

(4) When p or q is very small. Replace q by $1-p$ in the expansion and obtain

$$(q+p)^n = (1-p+p)^n = (1-p)^n \left(1 + \frac{p}{1-p}\right)^n$$

Suppose now that $n \rightarrow \infty$ as $p \rightarrow 0$ in such a way that the product np remains constant, say

$$np = m \therefore n = \frac{m}{p}$$

$$\text{and } (q+p)^n = (1-p)^{\frac{m}{p}} \left(1 + \frac{p}{1-p}\right)^{\frac{m}{p}}$$

$$\approx (1-p)^{\frac{m}{p}} (1+p)^{\frac{m}{p}}$$

Thus

$$(q+p)^n \rightarrow e^{-m} \left(1 + \frac{m^2}{2!} + \frac{m^3}{3!} + \dots + \frac{m^r}{r!} + \dots\right)$$

where the successive terms give the frequency of occurrence of 0, 1, 2, 3, . . . , r , events on the basis of each event not being prejudiced by what has previously occurred.

⁷B.S.T.J., Vol. XX, Jan., 1941, pp. 1-61.

Notes and Comments

Roll of Honour

The Board of Editors deeply regrets to have to record the deaths of the following members of the Engineering Department :—

While serving with the Armed Forces, including Home Guard.

Engineering Department ..	Dowse, V. C.	..	Skilled Workman, Class II	..	Ordinary Seaman, Royal Navy.
Belfast Telephone Area ..	Gillespie, W. J.	..	Unestablished Skilled Workman	..	Fusilier, Royal Irish Fusiliers.
Belfast Telephone Area ..	Neill, J.	..	Skilled Workman, Class II	..	Chief Petty Officer, Royal Navy.
Birmingham Telephone Area	Osborne, L.	..	Skilled Workman, Class II	..	Able Seaman, Royal Navy.
Cambridge Telephone Area	Dalton, P. G.	..	Unestablished Skilled Workman	..	Private, Northamptonshire Regiment.
Canterbury Telephone Area	Walker, W.	..	Labourer	Signalman, Royal Corps of Signals.
Edinburgh Telephone Area	Leslie, A.	..	Unestablished Skilled Workman	..	Signalman, Royal Corps of Signals.
Edinburgh Telephone Area	Rennic, H.	..	Unestablished Skilled Workman	..	Private, Royal Scots Regiment.
Glasgow Telephone Area ..	Young, J.	..	Labourer	Private, Highland Light Infantry.
London Telecommunications Region.	Couper, A. E.	..	Unestablished Skilled Workman	..	Sergeant Pilot, Royal Air Force.
London Telecommunications Region.	Dearn, A. S. A.	..	Unestablished Skilled Workman	..	Leading Signalman, Royal Navy.
London Telecommunications Region.	Lee, S.	..	Skilled Workman, Class II	..	Signalman, Royal Corps of Signals.
Nottingham Telephone Area	Martin, R. H.	..	Labourer	Signalman, Royal Corps of Signals.
Plymouth Telephone Area	Adams, L.	..	Unestablished Skilled Workman	..	Able Seaman, Royal Navy.
Sheffield Telephone Area ..	Jacques, W. J.	..	Unestablished Skilled Workman	..	Able Seaman, Royal Navy.
Shrewsbury Telephone Area	Lloyd, A. E.	..	Unestablished Skilled Workman	..	Lance - Corporal, Royal Corps of Engineers.
Stoke-on-Trent Telephone Area.	Holdcroft, J.	..	Unestablished Skilled Workman	..	Sapper, Royal Engineers.
Tunbridge Wells Telephone Area.	Noon, T.	..	Unestablished Skilled Workman	..	Private, East Yorkshire Regiment.

Recent Awards

The Board of Editors has learnt with great pleasure of the honours recently conferred on the following members of the Engineering Department :—

While serving with the Armed Forces, including Home Guard.

Test Section, Birmingham	Hartland, L.	Youth-in-Training	Home Guard	..	Commended by H.M. the King.
Test Section, Birmingham	Peacock, F. J.	Unestablished Skilled Workman	Home Guard	..	Commended by H.M. the King.

While serving with the Civil Defence Forces or on Post Office Duty.

Engineering Department, Liverpool.	Payne, F.	..	Mechanic-in-Charge, Grade II.	..	British Empire Medal.
Engineering Department, Liverpool.	Ashcroft, R. E.	..	Motor Mechanic	Commended by H.M. the King.
Engineering Department, Liverpool.	Ashworth, C.	..	Motor Mechanic	Commended by H.M. the King.
Engineering Department, Liverpool.	Smerden, J. F.	..	Motor Mechanic	Commended by H.M. the King.
Engineering Department, Liverpool.	Thirlwall, J. G.	..	Motor Mechanic	Commended by H.M. the King.

While serving with the Civil Defence Forces or on Post Office Duty (continued).

London Telecommunications Region.	Worthy, L. F.	..	Area Engineer	Member of the Order of the British Empire.	
London Telecommunications Region.	Baker, R. W.	..	Skilled Workman, Class I	British Empire Medal.	
London Telecommunications Region.	Higgins, J. H.	..	Unestablished Skilled Workman	British Empire Medal.	
London Telecommunications Region.	Horton, H. W.	..	Tradesman (Plumber)	British Empire Medal.	
London Telecommunications Region.	Jackson, A.	..	Skilled Workman, Class I	British Empire Medal.	
London Telecommunications Region.	Rouse, S. T.	..	Skilled Workman, Class II	British Empire Medal.	
London Telecommunications Region.	Raines, L. A.	..	Skilled Workman, Class II	British Empire Medal.	
London Telecommunications Region.	Tandy, A. B.	..	Skilled Workman, Class I	British Empire Medal.	
London Telecommunications Region.	Blaney, S. J.	..	Unestablished Skilled Workman	Commended by H.M. the King.	
London Telecommunications Region.	Cayzer, L. L.	..	Skilled Workman, Class II	Commended by H.M. the King.	
London Telecommunications Region.	Morrison, M. M.	..	Unestablished Skilled Workman	Commended by H.M. the King.	
London Telecommunications Region.	Potts, E. T.	..	Skilled Workman, Class II.	Commended by H.M. the King.	
Newcastle Telephone Area.	Bell, H.	Skilled Workman, Class I	British Empire Medal.

Birthday Honours

We regret that the following officer was inadvertently omitted from the list published in the July issue of Engineering Staff honoured by H.M. the King in the Birthday Honours List :—

Southampton Telephone Area.	Jennings, L. T.	..	Inspector	Medal of the Order of the British Empire.
-----------------------------	-----------------	----	-----------	----	----	----	---

A Method of Opening Steel Pipes

Reference was made in the April and July, 1937, issues of the Journal, to the use of the "Skilsaw" portable electric tool for stripping steel pipes from working telephone cables during the re-construction of Waterloo Bridge. This machine has been frequently used in recent months for cutting back steel pipes to reach sound cable and the work of slitting and opening the pipes has been considerably facilitated by the introduction of a carrier for positioning the tool on the pipe and of tools for opening the pipe after the slit has been made. The carrier and opening tools have been developed in the City area of the L.T.R.

The carrier, when in use, replaces the soleplate supplied with the machine, and consists, briefly, of a rectangular-shaped frame at each corner of which a wheel is fitted so that the frame may travel along the pipe to be cut. The body of the "Skilsaw" is attached to the carrier by bolts through slotted brackets at the front and rear of the carrier. The bracket at the front is mounted on a hinged vertical

member and adjustment for height is provided by a screw adjustment. The bracket at the rear is merely pivoted at the frame. The screw feed operated by the hand wheel serves to lower the abrasive disc gradually at the commencement of a cut until the steel pipe has been penetrated, and to take up the wear of the disc as the cut is continued. The disc is arranged to rotate in a vertical plane, perpendicular to the base frame of the carrier.

The new pipe opening tools consist of (a) a tongue on a nut which when rotated widens the slit cut by the Skilsaw disc to about $\frac{3}{4}$ in.; (b) the pipe opening claws which are inserted in the $\frac{3}{4}$ in. slit left by (a), and may be separated to about $5\frac{1}{2}$ in., and (c) an operating key which fits bolt heads on (a) and (b). Thus the section of pipe which has had the slit widened in this manner can be rotated and lifted clear of the cable.

A fuller description and photographs of the devices will be given in a later issue.

Regional Notes

Home Counties Region

INTERFERENCE ON P.O. WIRES FROM E.H.T. NETWORK

● On May 16th, 1941, an unusual fault developed on a power supply line near Hastings, which led to inductive disturbances on a large number of P.O. lines.

The first indication was the receipt of fault dockets reporting junction circuits noisy. Inductive disturbance was recognised, and insulation resistance, insulation resistance out of balance, conductor resistance, conductor resistance out of balance tests made. The junctions were well above the standards laid down. The disturbance, which took the form of a powerful hum of 50 c/s, was so pronounced at times that junction working from Beckley, Brede and Northiam exchanges was impossible. Other exchanges were affected, but the noise level never reached proportions to make the junctions unworkable. Communication with the local Supply Authority was soon established and they were asked to check over the conditions of their supplies as our lines were being affected. Within a short time they reported that all their 11 kV lines were well inside the permissible leakage limits, but that they had observed at all their transformers a very appreciable hum on the transformer assemblies. Further details were exchanged, and the local Supply Authority formed the opinion that the fault existed on a C.E.B. 132 kV line between Littlebrook and Hastings, and was being fed into their system. This opinion was based on:—

- (1) The absence of leakage currents on their 11 kV lines.
- (2) All their transformer assemblies were humming; and
- (3) The general parallelism between the C.E.B. line and the affected P.O. lines.

These preliminary investigations had occupied the major portion of Friday the 16th. On the morning of Saturday the 17th, further co-operation was arranged. A "hook-up" circuit was devised whereby listening on one of the affected lines was possible at the power station. By elimination tests, the 132 kV lines between Littlebrook-Hastings, Folkestone-Hastings, Eastbourne and Hastings, as well as the common lines between the C.E.B. station and the local power station were proved to be clear and not causing the interference. The local authority's 11 kV lines could not be tested at that time, as it would have affected trolleybus services, hospitals, cinemas, etc., and it was arranged that the tests should be resumed at midnight. On resumption, all 11 kV feeders were isolated one at a time while listening tests were carried out. Where "ring" circuits were involved the section of the ring was isolated at both ends.

The fault was proved to exist on a 11 kV spur from Rye transformer station towards Camber, and at daylight on Sunday, 18th, an examination of the spur was carried out, when the fault was finally located to a throw-over switch at Camber. The switch, which had been changed over some weeks previously, had been closed in such a manner that the knife blade was sprung on to the outside of the copper spring contacts. This small high resistance contact had caused minor arcing which grew larger as time went on, due to oxidation and pitting. The arc apparently caused a complex wave form which set up interference in nearby conductors: when the switch was restored to normal the interference ceased.

It was noticed that the periods of maximum interference coincided with maximum loads.

It is interesting to note that the three exchanges principally affected are double-battery exchanges, whereas Peasmarsh, Iden and Icklesham, which, although nearer the actual fault, were not affected, are trickle-charged single-battery exchanges. The lines connecting the affected exchanges have, however, a much greater degree of parallelism with the 11 kV network.

F.A.E.J.

LAYING 3-IN. S.A. DUCT WITH A MECHANICAL EXCAVATOR

The route taken followed the verge for most of the way, with one section in unmade road and another in tar macadam. For almost the whole of the distance of 1,470 yards the digging was in chalk with an earth covering varying from practically nothing to twelve inches. Although the normal approach to the buildings to be served was via a tarmac road, the route along the unmade road was taken, as this was more suitable for the employment of the excavator and was, for most of the way, free from other services.

Most of the trench was excavated by a mechanical excavator of the endless chain and bucket type built by Allens of Oxford, but in tarmac sections, and in front of dwellings where other services existed totalling approximately 330 yards, hand excavation was employed. The ducts were laid at carriageway depth throughout.

On the first day and part of the second day it rained continuously. During this time the staff were employed in excavating a road crossing by ordinary excavating tools. At the same time a line was sighted with trenching pins for the excavator to follow.

The excavator excavated approximately 40 yards of trench without mishap in a few minutes and was then stopped by a piece of metal being caught up in the chain which damaged two links. This put the excavator out of action until late in the morning of the following day.

It was found that the operator was not experienced in keeping a straight line and to overcome this difficulty a line between two pins was made and this followed by a pointer fitted on the excavator.

The chain on this excavator is carried over the end of a boom, and the hydraulic control for keeping this in a fixed position to ensure a regular depth of trench was found to be functioning incorrectly, and in consequence the bottom of the trench was uneven. The levelling up, however, was comparatively simple, as the depth obtained was slightly greater than necessary, the high spots were shovelled off and fine soil added to the hollows for final adjustment. The delay caused by stopping to level the trench prevented the duct laying keeping pace with the excavator and the machine was, therefore, often idle. The machine passed the soil in a long mound some two feet clear of the trench, and as it was in a finely divided state, it was easy to handle for return to the trench after duct-laying.

The machine was found to be capable of excavating 100 yards of trench per hour under favourable conditions. Difficulty arises in excavating clay as it sticks to the buckets and, in consequence, it is frequently necessary to stop the machine to empty the buckets with a spade.

The necessity for the hand digging prevented the early closing in of the trench after duct-laying with

the force available, and, therefore, a complete picture of the capabilities of the combination of machine and men cannot be given.

This work was completed at a very reasonable cost. Had the work been placed out to tender, the prices submitted would undoubtedly have been high on account of the presence of hard chalk soil. The laying of the 1,470 yards of ducts and filling in was completed in twelve working days in a total of 79 working hours.

F.G.K.

North Eastern Region

JOINTING ASBESTOS CEMENT DUCTS

A field trial of a new type of collar and ring for cement asbestos ducts has recently been carried out in the Leeds Telephone Area under supervision of officers from the Engineer-in-Chief's Construction and Research Branches.

The collars are constructed of asbestos cement, $7\frac{1}{2}$ ins. in length and $4\frac{1}{2}$ ins. internal bore, with a 30° straight internally chamfered end. The rubber rings are $2\frac{3}{4}$ ins. internal diameter and thickness $\frac{3}{8}$ in. The larger ring tends to make jointing operations more difficult and has a tendency to move the last collar backwards,

but this can be overcome by holding a fencing pin behind the collar. To avoid disturbance of the collar on the forward end of the leading duct, the pressure was applied to a jig placed inside the collar. Under wet conditions it was found that jointing could be carried out almost as rapidly and equally satisfactorily as when all components were dry.

On completion of the jointing a combined pressure and smoke test was applied to the completed section, both before and after filling in, and the results were quite satisfactory. Couplings C.I. No. 18 were used throughout, and when such couplings are employed it is suggested that a 2 ft. 6 in. length of asbestos cement duct of the same internal diameter as the collar be employed for terminating and an ordinary collar be used for leading out. A small quantity of packing will be required between the outer side of the asbestos cement and the sockets of the couplings.

The conclusion arrived at was that the new type of jointing was highly satisfactory and it would appear to the writer that provided the necessary care in bedding, filling, and ramming is exercised, the problem of constructing a watertight duct track has been solved.

G.W.B.

The Institution of Post Office Electrical Engineers

ESSAY COMPETITION, 1941

The Council offers five prizes of Two Guineas each for the five most meritorious Essays submitted by members of the Engineering Department of the Post Office below the ranks of Inspector and Draughtsman Class II, and, in addition, to award a limited number of Certificates of Merit.

A prize-winner in any previous competition is not eligible to enter, but this restriction does not apply to a competitor who has been awarded a certificate only.

An essay submitted for consideration of an award in the Essay Competition and also submitted in connection with the Junior Section I.P.O.E.E. prizes, will not be eligible to receive both awards.

In judging the merits of an essay, consideration will be given to clearness of expression, correct use of words, neatness and arrangement, and although technical accuracy is essential, a high technical standard is not absolutely necessary to qualify for an award. The Council hopes this assurance will encourage a larger number of entries. Marks will be awarded for originality of essays submitted.

Competitors may choose any subject relevant to current telegraph or telephone practice.

The Essay must be written on foolscap paper, and must not exceed 5,000 words. A quarter margin to be left on each page. A certificate is required to be furnished by each competitor, at the end of the essay, in the following terms:—

"In forwarding the foregoing essay of..... words, I certify that the work is my own unaided effort both as regards composition and drawing."

Address Signature

Date Rank

The Essays must reach The Secretary, The Institution of Post Office Electrical Engineers, G.P.O. (Alder House), London, E.C.1, by the 31st December, 1941.

The Council reserves the right to refrain from awarding the full number of prizes, or certificates if, in its opinion, the essays submitted do not attain a sufficiently high standard.

The result of the previous competition is given below.

ESSAY COMPETITION, 1939-40, RESULTS

The Judges have reported to the Council that the Prize Winners, arranged in order of merit, are:—

- G. J. MEDFORD, S.W.II., Altrincham, "A few facts about the Cause of Faults, by a Subscribers' Maintenance Man."
- A. IRWIN, S.W.II., Barrow-in-Furness, "The Cathode-ray Tube—its Development and Uses."
- C. A. GRAY, U.S.W., Repeater Station, Edinburgh, "The S.T. & C. Carrier System No. 5."
- F. H. SAXBY, A/S.W.I., Leicester, "The Organisation of Automatic Exchange Maintenance."
- R. W. D. GLOVER, A/S.W.I., Archway Exchange, London, "Maintenance Direction in Automatic Exchanges."

Certificates of Merit have been awarded to the following five competitors:—

- W. WORSFOLD, S.W.I., Guildford, "Youths and their Training."
- R. A. SUDFELL, A/S.W.I., Whitstable, "The need of Specialist Supervision of Automatic Maintenance."
- A. F. SHORT, S.W.I., Waterlooville, Hants., "Underground Maintenance Control, Organisation and Procedure at Portsmouth."
- A. E. PLASS, S.W.I., Tunbridge Wells, "Telegraphy."
- P. A. NEWTON, A/S.W.I., Southsea, "Portsmouth Maintenance Procedure, Overhead Renewals and D.P. Inspection."

Fifty-three entries were received.

Staff Changes

Promotions

Name	Region	Date	Name	Region	Date
<i>From Area Engr. to Area Engr. with Allce.</i>			<i>From Insp. to Chief Insp.—continued.</i>		
Powell, H. W.	N.W. Reg.	1.6.41	Freshwater, G. E.	Mid. Reg.	29.6.41
<i>From Asst. Engr. to Area Engr.</i>			Thomas, G. E.	W. & B.C. Reg.	29.6.41
White, J. A.	H.C. Reg.	6.6.41	Beniston, S.	N.W. Reg. to Scot. Reg.	28.5.41
Clark, H. V.	E-in-C.O.	6.6.41	King, E. F. H.	E-in-C.O.	18.5.41
Vann, C. J.	S.W. Reg. to H.C. Reg.	24.7.41	Gillard, C. H.	E-in-C.O. to S.W. Reg.	22.5.41
Roberts, J. H.	H.C. Reg. to Scot. Reg.	13.7.41	Green, L.	E-in-C.O.	1.5.41
Pearson, S. G.	N.W. Reg.	13.8.41	Thorpe, H. V.	H.C. Reg. to Scot. Reg.	29.6.41
Davison, G. N.	E-in-C.O.	13.8.41	Crump, S. G.	H.C. Reg.	13.7.41
<i>From Chief Insp. to Asst. Engr.</i>			Garfath, A. J. A.	H.C. Reg.	1.7.41
Treglown, P. G.	S.W. Reg.	5.6.41	Baker, F. C.	E-in-C.O.	1.11.39
Smith, R.	N.E. Reg. to Mid. Reg.	17.8.41	Broadhurst, J. H.	E-in-C.O. to Scot. Reg.	22.6.41
Tunnickliff, T.	Mid. Reg.	29.6.41	Bucklitsch, E. K. F.	S.W. Reg.	2.3.41
Woodley, E. T. M.	S.W. Reg.	29.6.41	May, R. H.	E-in-C.O. to N.W. Reg.	20.7.41
Johnson, L. P.	H.C. Reg. to L.T.R.	22.6.41	Pemberton, W. J.	E-in-C.O.	1.6.41
Hardy, J.	Mid. Reg.	6.6.41	Walker, R. C. W.	E-in-C.O. to N.W. Reg.	21.7.41
Queen, J.	E-in-C.O.	28.5.41	Dolman, R. A.	Mid. Reg.	20.7.41
Ellenden, A. H.	H.C. Reg.	To be fixed later	Hall, G. W.	N.E. Reg. to S.W. Reg.	29.6.41
Allan, F. W.	N.E. Reg.	To be fixed later	Connelly, A. E.	N. Ire. Reg.	17.3.41
Middleditch, E. G. H.	E-in-C.O.	2.8.41	Baker, W. J.	H.C. Reg.	20.7.41
Hunt, A. H. F.	E-in-C.O.	2.8.41	Cleary, C. L.	N.W. Reg.	15.7.41
Barratt, L. W.	S.W. Reg.	2.8.41	Bowers, R.	Mid. Reg.	7.8.41
Pooley, E. H.	H.C. Reg.	To be fixed later	Crighton, R. D.	Scot. Reg.	7.12.39
Mitchell, C. W. A.	E-in-C.O.	2.8.41	Clark, P. R. T.	Test Sectn., B'ham, to Test Sectn., Ldn.	29.6.41
<i>From Chief Insp. to Chief Insp. with Allce.</i>			Worthington, A. G.	E-in-C.O.	29.6.41
Nixon, G.	Mid. Reg.	10.9.39	Ellis, W.	N.E. Reg.	To be fixed later
Cross, W. H.	N.W. Reg.	8.6.41	Bulfin, A.	N.E. Reg.	To be fixed later
Grierson, A.	N.E. Reg.	15.6.41	Tipple, J. W.	W. & B.C. Reg. to N.W. Reg.	To be fixed later
Chadwick, J.	N.W. Reg.	21.7.41	Thompson, J. E.	N.E. Reg. to Mid. Reg.	To be fixed later
Jones, C. J.	N.E. Reg.	20.7.41	Mockridge, W. C.	S.W. Reg.	2.3.41
Delahunty, T. P. J.	L.P. Reg.	1.8.41	Foulsham, R.	H.C. Reg. to Mid. Reg.	20.7.41
<i>From Insp. to Chief Insp.</i>			Bennett, H. V.	N.W. Reg. to Thurso R/Stn.	3.1.41
Hewer, A. G.	L.T.R.	20.7.41	<i>From Draughtsman Class II to Draughtsman Class I.</i>		
Bale, W. F.	L.T.R.	1.5.41	Dillaway, E. G.	L.T.R.	29.8.41
Simpson, W. F.	L.T.R.	30.3.41	<i>From Repr. Officer Class II to Insp.</i>		
Masters, F. R.	L.T.R.	1.5.41	Carter, G. W.	H.C. Reg. to Barnet R.S.S.	22.5.41
Hart, S.	L.T.R.	7.5.41	<i>From Draughtsman (Unest.) to Insp.</i>		
Putland, R. C.	Mid. Reg.	15.6.41	Perry, E. T.	E-in-C.O.	1.8.41
Barrett, H. C.	L.T.R.	30.4.41	<i>From S.W.I. to Insp.</i>		
Utting, A. P.	E-in-C.O.	25.5.41	Smith, E. E. M.	E-in-C.O.	3.6.41
Lees, W.	Scot. Reg.	20.4.41	Duff, J. T.	E-in-C.O.	8.6.41
Morris, H. M.	N.E. Reg.	8.6.41	Turbin, C. A. R.	E-in-C.O.	8.6.41
Harvey, H. C.	N.E. Reg.	15.6.41	Michie, P. G.	E-in-C.O.	19.5.41
Greasley, E. G.	Test Sectn., Ldn.	15.12.40	Perkins, W. T.	E-in-C.O.	15.6.41
Patterson, R.	N. Ire. Reg.	18.10.40	Bamford, A.	Mid. Reg. to E-in-C.O.	10.3.41
Moore, H. J.	L.T.R.	1.5.41	Higson, W.	Mid. Reg. to E-in-C.O.	10.3.41
Harris, G.	L.T.R.	18.5.41	Tankard, A. H.	N.W. Reg. to E-in-C.O.	21.4.41
Williamson, F. J.	L.T.R.	30.4.41	Noble, W. A.	Scot. Reg. to E-in-C.O.	22.5.41
Eagar, H. E. J.	L.T.R.	30.4.41	Harrison, A.	N.W. Reg. to E-in-C.O.	26.5.41
Lawson, G. W. G.	L.T.R.	19.6.41	Utting, H.	E-in-C.O.	25.5.41
Bell, D.	L.T.R.	1.7.41	Teale, J.	N.E. Reg. to E-in-C.O.	22.6.41
Bremner, W.	Scot. Reg.	25.1.40	Hardman, E.	N.W. Reg. to E-in-C.O.	25.5.41
Cooper, H.	Mid. Reg.	16.12.37	Harpley, C.	N.W. Reg. to E-in-C.O.	15.6.41
McBurnie, R. S.	N.W. Reg.	30.4.41	Slater, T. A.	N.E. Reg. to E-in-C.O.	22.6.41
Kumary, F. J.	S.W. Reg.	5.6.41	Horsfield, B. R.	N.E. Reg. to E-in-C.O.	1.6.41
Stevens, E. C. C.	E-in-C.O. to N.E. Reg.	11.5.41	Proudlock, J. W.	E-in-C.O.	7.7.41
Salt, J. R.	Scot. Reg.	28.5.41	Beale, H. J. P.	E-in-C.O.	18.7.41
Handy, T. A.	Mid. Reg.	28.5.41	Rogers, F. E.	E-in C.O.	15.6.41
Manners, W.	W. & B.C. Reg.	29.6.41			
Granger, S. B.	E-in-C.O.	16.6.41			
Mason, A.	N.W. Reg.	To be fixed later			
Martin, H. R.	Mid. Reg.	1.6.41			
Stansfield, G. V.	N.W. Reg.	4.5.41			

Transfers

Name	Region	Date	Name	Region	Date
<i>Area Engr.</i>			<i>Insp.</i>		
Jones, R. E.	E-in-C.O. to L.T.R.	1.8.41	Potts, C. M.	E-in-C.O. to N.E. Reg.	2.8.41
<i>Asst. Engr.</i>			Evans, F. C. M. N.	E-in-C.O. to L.T.R.	11.8.41
Sharpe, H. T. A.	E-in-C.O. to L.T.R.	3.6.41	Giles, F. R.	H.C. Reg. to E-in-C.O.	6.7.41
			<i>Draughtsman Class II.</i>		
			Hodges, R. R.	L.T.R. to S.W. Reg.	5.8.41

Retirements

Name	Region	Date	Name	Region	Date
<i>Area Engr.</i>			<i>Chief Insp. with Allce.—continued</i>		
Rhodes, T. C.	H.C. Reg.	3.6.41	Scott, F.	N.E. Reg.	19.7.41
Gawthorne, G. J.	L.T.R.	31.7.41			
<i>Chief Insp. with Allce.</i>			<i>Chief Insp.</i>		
Manton, C.	L.P.R.	30.6.41	Kennard, T. G.	L.T.R.	19.7.41
Heaton, A.	N.W. Reg.	20.7.41	Sullivan, W. A.	L.T.R.	18.6.41
			Shaw, J. W.	L.T.R.	30.6.41

Resignations

Name	Region	Date			
<i>Asst. Chemist.</i>					
Povey, N. G. W.	Test Sectn. (Ldn.)	3.5.41			

CLERICAL GRADES

Promotions

Name	Region	Date	Name	Region	Date
<i>From E.O. to S.O.</i>			<i>From C.O. to H.C.O.</i>		
French, F. S.	E.-in-C.O.	27.5.41	Basham, H.	H.C. Reg.	19.4.41
Scrivener, W. H.	E.-in-C.O.	27.8.41	Bevan, T. F.	H.C. Reg.	8.6.41
<i>From C.O. to E.O.</i>			Renton, J.	Scot. Reg.	1.6.41
Duncan, W. B.	E.-in-C.O.	5.6.41	Whyte, T. H.	Scot. Reg.	7.6.41
(Notionally <i>in absentia</i>)			Taylor, C. H.	S.W. Reg.	13.7.41
Harmon, Miss D. M.	E.-in-C.O.	12.6.41	Craighead, J. H.	N.E. Reg.	1.6.41
Turnney, H. E.	E.-in-C.O.	12.6.41	Wyatt, D. C.	N.E. Reg.	1.7.41
Wilby, Miss M.	E.-in-C.O.	12.6.41	Woodhead, C. O.	N.W. Reg.	1.8.41
Burrows, W. H.	E.-in-C.O.	27.8.41			

Note: All promotions during the war are on an "Acting" basis.

BOARD OF EDITORS

A. J. GILL, B.Sc., M.I.E.E., M.I.R.E., Chairman.
 F. E. NANCARROW, A.R.C.Sc., M.I.E.E.
 P. B. FROST, B.Sc., M.I.E.E.
 A. H. MUMFORD, B.Sc.(ENG.), M.I.E.E.
 C. W. BROWN, A.M.I.E.E.
 R. E. JONES, M.Sc., A.M.I.E.E.
 H. LEIGH, B.Sc.(ENG.), A.M.I.E.E., Acting Managing Editor.
 G. E. STYLES, A.M.I.E.E., Acting Assistant Editor.

Copyright

The entire contents of this JOURNAL are covered by general copyright, and special permission is necessary for reprinting long extracts, but Editors are welcome to use not more than one-third of any article, provided credit is given at the beginning or end thus: "From the *Post Office Electrical Engineers' Journal*."

The Board of Editors is not responsible for the statements made or the opinions expressed in any of the articles in this JOURNAL, unless such statement is made specifically by the Board.

Communications

All Communications should be addressed to the Managing Editor, *P.O.E.E. Journal*, Engineer-in-Chief's Office, Alder House, Aldersgate Street, London, E.C.1. Telephone: HEADquarters 1234. Remittances should be made payable to "The *P.O.E.E. Journal*" and should be crossed "& Co."

Binding Cases

Cases for binding are available, and may be obtained from the Local Agents for 1s. 9d. Subscribers can have their copies of Volumes bound, at a cost of 3s., by sending the complete set of parts to the Local Agents or to the *P.O.E.E. Journal*, Engineer-in-Chief's Office, Alder House, Aldersgate Street, London, E.C.1. Orders for binding for Vols. 1-19 should indicate whether the original binding case with black lettering, or the later pattern with gold, is required. Cases with gold lettering are the only type stocked from Vol. 20 onwards.

Back Numbers

The price of the JOURNAL, which is published quarterly, is 1s. (1s. 3d. post free) per copy, or 5s. per annum post free. Back numbers can be supplied, subject to availability of stocks, at 1s. each (1s. 3d. post free). Orders for back numbers may be sent to the Local Agents or to the Publishers.

Advertisements

All communications relating to space reservations should be addressed to the Advertisement Editor, *P.O.E.E. Journal*, Alder House, Aldersgate Street, London, E.C.1. Communications regarding advertisement copy, proofs, etc., should be addressed to the Publishers, Messrs. Birch & Whittington (Prop. Dorling & Co. [Epsom], Ltd.), 49 Upper High Street, Epsom, Surrey.

Introducing the DECADE OSCILLATOR!

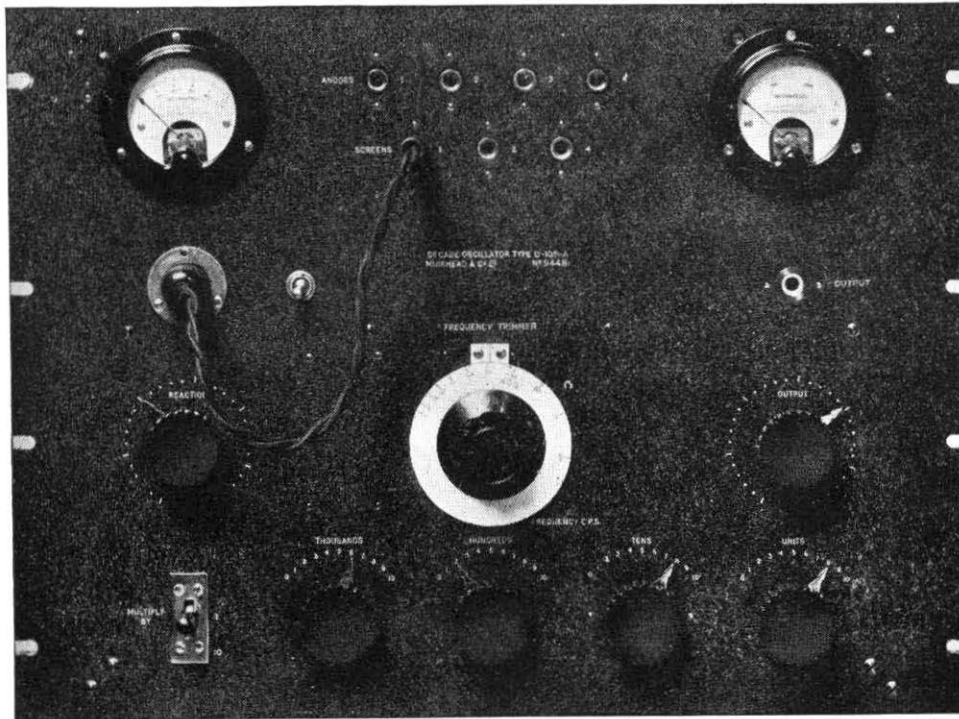

The **MUIRHEAD-WIGAN DECADE OSCILLATOR** Type D-105-A, illustrated, is an instrument of outstanding performance embodying something entirely new in oscillator design.

FREQUENCY IS DIRECT READING TO PRECISION ACCURACY ON FOUR DECADES.

There are no troublesome calibration charts to refer to or engraved scales to adjust.

*“It’s as easy to use
as a resistance box”*

For full particulars of this and other Decade Oscillators, write for Bulletins B-320-A, B-321-A and B-528-A.

MUIRHEAD & CO. LTD., ELMERS END, BECKENHAM, KENT.
Telephone: Beckenham 0041-0042

Specification :

FREQUENCY

1 c.p.s. to 111.1 Kc/s on two ranges:—
1 c.p.s. to 11.11 Kc/s by 1 c.p.s. steps.
10 c.p.s. to 111.1 Kc/s by 10 c.p.s. steps.

ACCURACY

$\pm 0.2\%$ or 2 c.p.s. over the entire frequency range.

OUTPUT 2 watts maximum.

HARMONIC CONTENT

2% at 2 watts : 1.25% or less below 1 watt.

POWER SUPPLY 200 to 250 v. 50 c.p.s.

MUIRHEAD

FOR OVER 60 YEARS DESIGNERS AND MAKERS OF PRECISION INSTRUMENTS

"AUSTRALIA WILL

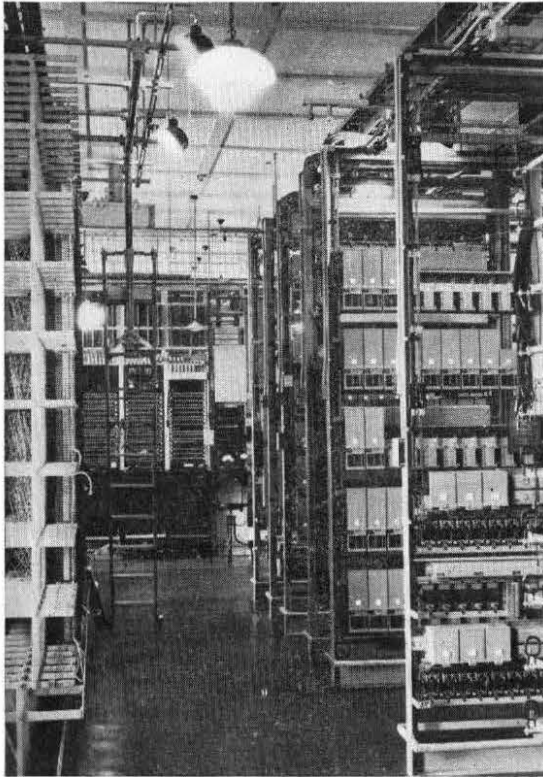

An interior view of Rockhampton Exchange.

It is traditional that Australia is in the forefront, whether in the defence of or in the application of modern developments to her national or civic needs. of the latter is provided by the new Rockhampton Automatic Telephone Exchange. 1,600 lines are installed initially with an associated 8 position trunk board exchange has an ultimate capacity of 2,900 lines. It is equipped with the 32A Selector (B.P.O. type 2,000), the last word in automatic telephone switching. In result Rockhampton subscribers have a standard of telephone service equal in any part of the world.

In 1889 the first telephone exchange was installed at Rockhampton and it

in a wooden building which was really little more than a shack—a striking contrast when compared with the large and up-to-date building in which the exchange is now installed. At that time there were only 37 subscribers and even this number dwindled during the next few years. In 1900, however, the number had increased to 130, and to-day about 1,700 subscribers enjoy the advantages of Strowger Automatic Telephone Exchange, Rockhampton, Australia, provides yet further proof that the telephone dial rotates with the world.

This exterior view shows the modern two-storied building in which the equipment is installed.



STROWGER AUTOMATIC TELEPHONE EQUIPMENT

...L BE THERE !”

...the Empire
...An example
...Exchange.
...ard and the
...ne Strowger
...irding, and
...quid to that

...vs housed

...vontained.

...th number

...erhe total

...rirs enjoy

...m Rock-

...strowger



AUTOMATIC TELEPHONE & ELECTRIC CO. LTD.

NORFOLK HOUSE, NORFOLK ST., STRAND, W.C.2.

Phone, Temple Bar 9262 • Grams, Auteko, Estrand, London

STROWGER WORKS, LIVERPOOL, 7

Phone, Stoneycroft 4830 • Grams, Strowger, Liverpool



You need never worry about PETROL!

By changing over to Electric Vehicles *now* you not only escape wartime transport restrictions, but you also cut the cost of door-to-door deliveries for *all time*. Moreover, 'Electrics' need very little attention throughout their extremely long life, and they are very easy to drive. To get

the best out of 'Electrics' see that they are equipped with Exide-Ironclad batteries. These batteries stand the wear and tear of short-distance transport better than any other. They are made by the Chloride Company, who offer the most efficient service in the country.

USE 'ELECTRICS'

POWERED BY

Exide-Ironclad
BATTERIES

'Still keep going when the rest have stopped'

FUEL FOR 'ELECTRICS' comes from British coal
— saves vital shipping space and foreign exchange

*For further details about electric vehicles and batteries write to : The Chloride Electrical Storage Co. Ltd.,
Grosvenor Gardens House, Grosvenor Gardens, London, S.W.1.

Telephone : VICtoria 2299.

Telegrams : Chloridic, Sowest, London.

Ferranti

CLIP-ON AMMETER

Just turn the switch to change the range.

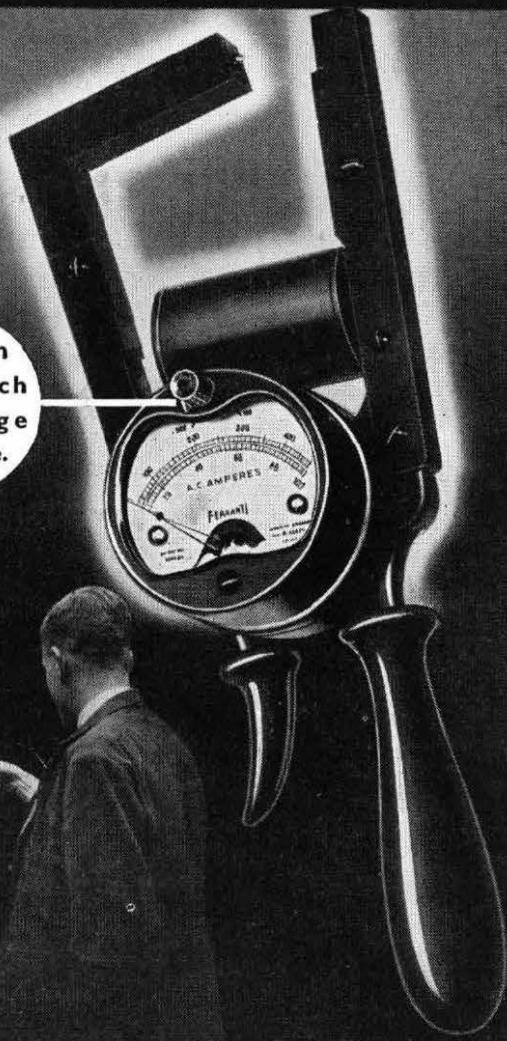

THE CLIP-ON AMMETER has become established as an indispensable instrument for the rapid measurement of currents in busbars, fuses and cables. You simply take the instrument in one hand, clip round the conductor and observe the reading! Don't worry if the conductor is bare—the core is completely insulated and the frame is of moulded bakelite.

RANGES AVAILABLE :

0 - 10 - 50 Amps.	0 - 20 - 100 Amps.
0 - 50 - 250 Amps.	0 - 100 - 500 Amps.
	0 - 200 - 1000 Amps.

Write for List IN. 11.

FERRANTI LTD., HOLLINWOOD, LANCS.
London Office, BUSH HOUSE, ALDWYCH, W.C.2.

F1.33a

Fixing?

HERE'S A SOLUTION TO YOUR PROBLEM

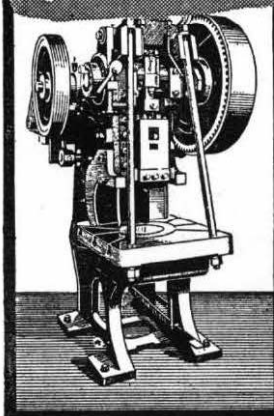

Each Rawlplug Technical Specialist has spent many years studying Fixing problems and is therefore well able to advise you on the subject. He is backed by works technicians and the research facilities of our own laboratories. An appointment can be arranged with one of our specialists by writing to the address below.

If your problem does not require the special attention of a Representative, make sure you have at hand a copy of our 24 page brochure "Fixing Devices that grip the World." And if you are further interested in fixing problems you can obtain, free, a copy of our 216 page Technical Handbook "Modern Fixing Practice" by applying on a trade letter heading.



THE RAWLPLUG CO., LTD.

B259a Rawlplug House, Cromwell Rd., London, S.W.7.

High Quality mouldings

Ebonestos have produced many of the finest mouldings manufactured in compositions, Bakelite, Urea, Diakon, and other synthetic resins. For the past 42 years, our reputation for finish and accuracy has been second to none.

Let us know your moulding requirements, and we shall be pleased to send one of our technical experts to discuss the matter with you, or, if you prefer it, meet you at our factory.

Moulders to the General Post Office, Admiralty, Air Ministry and other Government Departments.

EBONESTOS

INDUSTRIES LIMITED

EXCELSIOR WORKS, ROLLINS STREET,
LONDON, S.E.15 Telephone: New Cross 1913 (6 lines)

Solder THE MODERN AND SPEEDY WAY

USE ERSIN MULTICORE

THE SOLDER WIRE
WITH 3 CORES OF
NON-CORROSIVE
ERSIN FLUX



- Avoids Dry Joints
- Increases Electrical Efficiency of Joints
- Speedily makes Sound Joints on Dirty or Oxidised Surfaces
- Always Correct Proportions of Flux and Solder
- No Additional Flux Required
- Low Melting Point (190° C. for 60/40 alloys)
- Approved by Air Ministry & G.P.O.
- All-British and acknowledged by the Leading Manufacturers to be the finest Cored Solder in the World.

FREE Two informative publications on soldering have been issued by Multicore Solders Ltd. Executives are invited to send for copies and a free sample of Multicore Solder.

MULTICORE SOLDERS LTD., BUSH HOUSE, LONDON, W.C.2

Telephone: TEMple Bar 5583/4

Electrical Standards for Research and Industry

Testing and Measuring Apparatus
for Communication Engineering

BRIDGES — Capacitance
Inductance
Resistance

RESISTANCES

INDUCTANCES

CONDENSERS

OSCILLATORS

WAVEMETERS

H. W. SULLIVAN
— LIMITED —

London, S.E.15

ALL TYPES — ALL FREQUENCIES — ALL ACCURACIES

Tel. New Cross 3225 (Private Branch Exchange)

LATEST A.M.I.E.E. RESULTS

In the recent Examinations held by the Institution of Electrical Engineers 366 candidates sat who had taken B.I.E.T. Courses. Of these 350 were successful in passing the examinations. We believe this record of 350 successes out of 366 entrants has never before been approached by any oral or correspondence tutorial organisation, and indicates the very high efficiency of the modern system of Technical Training which we have laid down.

The B.I.E.T. tutorial organisation is waiting to assist you—either with a short specialised course or complete training for a recognised Examination.

For years we have specialised in coaching for the various P.O.E.D. Examinations with outstanding success. We shall be pleased to arrange suitable instruction against the day when the competitions will be resumed.

WE GUARANTEE "NO PASS—NO FEE"

May we send a copy of "ENGINEERING OPPORTUNITIES"? Containing 208 pages of most useful advice and detailed information on over 200 Home-Study Courses and Examinations, this handbook is of very real value to the ambitious engineer. A postcard will bring the Handbook by return—FREE, post free and without obligation.

British Institute of Engineering Technology

369, Shakespeare House

17, 18 & 19, Stratford Place, Oxford Street
London, W.1

LONDEX for RELAYS

OF ALL TYPES

(except telephone relays) including time lag relays, high sensitive relays, etc. for A.C. or D.C. operation. 2 V.A. coil consumption from 2-600 volts, tested to 2,000 volts, unmounted and in cast iron casing. Synchronous Process Timers and complete control plants. *Apply for leaflet SPN/PO*

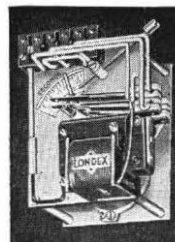

SYNCHRONOUS TIME
DELAY RELAY PRL—
Models ranging from
5 secs. to 28 days.

LONDEX LTD.

Electrical Remote Control Engineers and Manufacturers
Anerley Works, 207 Anerley Road, London, S.E.20

Telephone: SYDENHAM 6258 6259

ALTON

Batteries

of

Merit

**THE
ALTON BATTERY CO. LTD.**

ALTON · HANTS

★
ALTON & FULLER

BATTERIES

Telephone: ALTON 2267 & 2268

Telegrams: "BATTERY, ALTON"

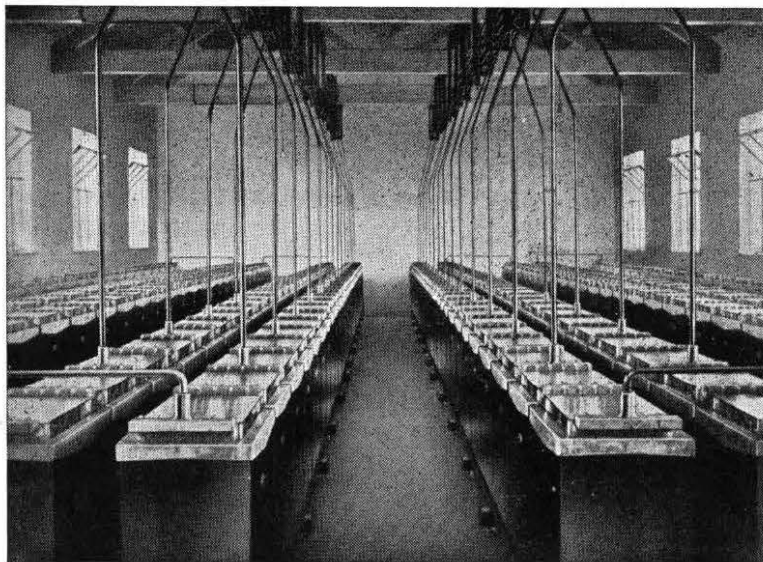

*ALTON Battery of 264 DLWII Type Cells at a
Corporation Electricity Works*

ACTION . . .

"Can do" is easily carried about.

Walter Scott.

In matters relating to stationary batteries for all purposes, the Alton organization by virtue of its experience and competence is able to carry out all conceivable normal requirements. This applies, too, to replating—whether the original battery be of Alton or other manufacture. There are, in short, few stationary battery problems for which the Alton organization cannot provide a solution. If action is possible, then Alton "can do."

CONSTANT POTENTIAL RECTIFICATION

15 WATT TO 1.2 KW "WESTAT" EQUIPMENTS IN SERVICE



150 watt "Westat."
Output 50.54 volts 3 amps.

Many hundreds of the Westinghouse "Westat" Constant Voltage Rectifiers for use with batteries are now in service. Outputs range from 15 watts to 1.2 kW, and they are used for floating across a battery and providing a periodical full charge.

The essential equipment is a rectifier, two transformers and a condenser, with a small choke for supplying battery load. It is a complete departure from the usual schemes for voltage stabilisation, as it does not depend for its operation on the use of gas discharge tubes, barreters or D.C. saturated chokes.



600 watt "Westat."
Output 50.54 volts 12 amps.

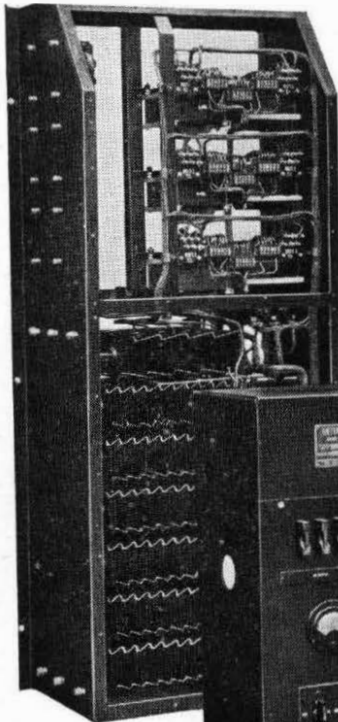

It compensates for load and mains input variations and provides not only constancy of mean voltage, but also constancy of instantaneous voltage by conversion of single-phase to three-phase power at medium and large loads.

Full details of the "Westat" for use with batteries, and of the "Noreg" for use without batteries are given in descriptive pamphlet No. 111, a copy of which may be obtained from Dept. P.O.E.J.



1.2 kW "Westat" using "Westalite" rectifiers.
Output 50.54 volts 24 amps.

Three-phase 0.9 kW "Westat" with separate control unit, for use on a rail coach.
Output 48.54 volts 18 amps.

Westinghouse
'WESTAT'
CONSTANT VOLTAGE RECTIFIER
for use with batteries

Represented in INDIA by
Saxby & Farmer (India) Ltd.,
Calcutta.

Represented in AUSTRALIA by
McKenzie & Holland (Australia)
Pty., Ltd., Melbourne.

WESTINGHOUSE BRAKE & SIGNAL CO. LTD., PEW HILL HOUSE, CHIPPENHAM, WILTS.

Ericsson



*Modern telephone
apparatus..*

The new automatic telephone No. 1002 has a casework of moulded bakelite. It incorporates a sliding instruction tray and renewable writing pad.

Dimensions $5\frac{1}{2} \times 9\frac{1}{4} \times 7$.

Weight 6 lbs.

Full particulars from makers.

ERICSSON TELEPHONES, LTD.,

Head Office : 22 Lincoln's Inn Fields, W.C.2

(Phone : HOLborn 6936)

Ericsson
TELEPHONES

INDEX TO ADVERTISERS

Alton Battery Co., Ltd., The	xviii	Institution of Post Office Electrical Engineers, The	xxiii & xxiv
Automatic Coil Winder & Electrical Equipment Co., Ltd.	iii	Londex, Ltd.	xvii
Automatic Telephone & Electric Co., Ltd. ..	xii & xiii	Muirhead & Co., Ltd.	xi
British Institute of Engineering Technology ..	xvii	Multicore Solders, Ltd.	xvi
Caplin Engineering Co., Ltd.	viii	Nife Batteries, Ltd.	ix
Chloride Electrical Storage Co., Ltd., The..	xiv	Pirelli-General Cable Works, Ltd.	xxvi
Creed & Co., Ltd.	xxiii	Rawplug Co., Ltd., The	xv
Ebonestos Industries, Ltd.	xv	Siemens Brothers & Co., Ltd.	vi & vii
Edison Swan Electric Co., Ltd., The	ii	Smith, Frederick & Co.	xxv
Elliott Bros. (London), Ltd.	xxv	Sullivan, H. W., Ltd.	xvii
Ericsson Telephones, Ltd.	xx & xxi	Telephone Manufacturing Company, Ltd. ..	x
Ferranti, Ltd.	xv	Turner, Ernest	xxii
General Electric Co., Ltd., The	ii & iv	United Insulator Co., Ltd.	v
Hall Telephone Accessories (1928), Ltd. ..	xxiii	Westinghouse Brake & Signal Co., Ltd. ..	xix

TURNER DIFFERENTIAL MILLIAMMETERS G.P.O. No. 17 & No. 18

Meet the most
exacting demands
for balancing currents
in multiplex telegraph circuits.

—A quality
product of outstanding
merit—

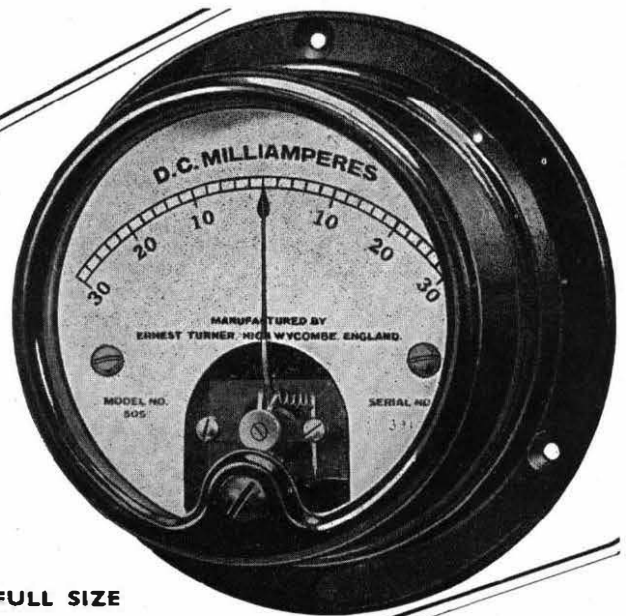

FULL SIZE

Also manufacturers of G.P.O.
Detector No. 4, and a compre-
hensive line of instruments for
precision electrical measure-
ments.

ERNEST TURNER ELECTRICAL INSTRUMENTS, Ltd.

**CHILTERN WORKS,
49-73 TOTTERIDGE AVENUE,
HIGH WYCOMBE,
BUCKS, ENGLAND**

Telephone : High Wycombe 1301, 1302.
Telegrams : Gorgeous. High Wycombe.

PROGRESS IN TELEPRINTER TRANSMISSION

THE NEW CREED TELEPRINTER TRANSMITTING UNIT S 2184

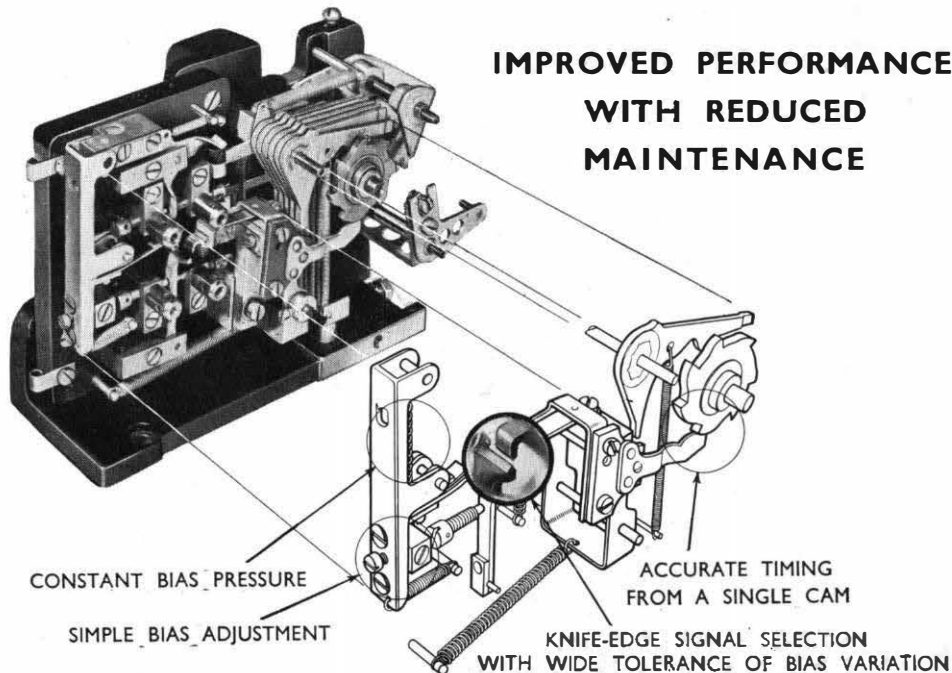

IMPROVED PERFORMANCE
WITH REDUCED
MAINTENANCE

CREED & COMPANY LIMITED



TELEGRAPH HOUSE, CROYDON

Hall Telephone Accessories (1928) Limited

Suppliers to the British Post Office, Air Ministry,
Admiralty, War Office and Foreign Government
Departments.

Manufacturers of prepayment telephone
multi-coin collectors, gas leak
indicators, precision instruments,
automatic stamp selling and ticket
selling machines, automatic slot
machines and fire alarm apparatus.

Registered Office:

**70, DUDDEN HILL LANE, WILLESDEN,
LONDON, N.W.10**

Tel. WILLESDEN 5141/2/3.

Also SOUTH WALES

Order Your Next JOURNAL Now!

THE Post Office Electrical Engineers' Journal is, like all other publications, subject to paper rationing. It is therefore essential to reduce to a minimum the margin of the number of copies printed over those ordered in advance. If you have not previously given a standing order please do so now, and if you are a regular subscriber please advise your local agent or the publishers, as early as possible, of any change in your requirements. In this way you will assist in eliminating waste and also ensure that your copy of the Journal is available each quarter.

THE INSTITUTION OF POST OFFICE ELECTRICAL ENGINEERS

PRINTED PAPERS

The following papers contributed to the proceedings of the Institution have been printed by authority of the Council and may be obtained, if still in print, from

"THE LIBRARIAN, The Institution of Post Office Electrical Engineers, G.P.O. (ALDER HOUSE), LONDON, E.C.1."

The prices do *not* include postage, and in every case, Members, Associate Members and Associates have the privilege of purchasing copies at two-thirds the stated price.

No. 121	"X-RAYS, AND THE STRUCTURE OF SOME ENGINEERING MATERIALS."—W. G. RADLEY, B.Sc. 1929	9d.
No. 122	"THE MEASUREMENT OF RELAY TIMES."—R. W. PALMER, A.M.I.E.E. 1929.. .. .	9d.
No. 123	"MODERN ELECTRICAL ILLUMINATION."—J. J. EDWARDS, B.Sc.(Eng.), A.C.G.I., D.I.C. 1928	9d.
No. 124	"THE MEASUREMENT OF SOUND AND ITS APPLICATION TO TELEPHONY."—A. J. ALDRIDGE, A.C.G.I., A.M.I.E.E. 1929	9d.
No. 125	"THE DEVELOPMENT OF AUTOMATIC ROUTINERS IN THE BRITISH POST OFFICE."—A. SPRIGHT, A.M.I.E.E. 1929	9d.
No. 134	"SOUND AND HEARING."—Capt. N. F. CAVE-BROWNE-CAVE, B.Sc., A.M.I.E.E. 1930.. .. .	1s.
No. 136	"SOME DEVELOPMENTS IN TELEGRAPH TECHNIQUE AS APPLIED TO RADIO CIRCUITS."—H. FAUCKNER, B.Sc., A.M.I.E.E., and G. T. EVANS. 1931.	1s.
No. 139	"DISTRICT ACCOUNTING."—T. FEWSTER. 1931	9d.
No. 140	"SOME NON-METALLIC SUBSTANCES AND THEIR CHARACTERISTICS."—Capt. N. F. CAVE-BROWNE-CAVE, B.Sc., A.M.I.E.E. 1931	9d.
No. 142	"PRIVATE BRANCH EXCHANGE INSTALLATIONS."—R. T. A. DENNISON. 1932	1s. 3d.
No. 146	"LAYING ARMoured CABLE BY MEANS OF A MOLE-DRAINER."—L. G. SEMPLE, B.Sc.(Eng.), and R. O. BOCKOCK, B.Sc.(Eng.). 1932	9d.
No. 147	"DESIGN AND CONSTRUCTION OF ELECTRIC WAVE FILTERS."—R. J. HALSEY, B.Sc., etc. 1932.	1s. 3d.
No. 148	"STORES SPECIFICATIONS AND ACCEPTANCE TESTING."—Capt. J. LEGG, B.Sc., A.M.I.E.E. 1933	9d.
No. 149	"RECENT DEVELOPMENTS IN UNDERGROUND CONSTRUCTION, LAYING AND LOADING ARMoured CABLES."—J. E. Z. BRYDEN, B.Sc.(Eng.), A.M.I.E.E., and T. HARREAVES, A.M.I.E.E. 1933	1s.
No. 150	"TELEPRINTERS."—E. S. RITTER, M.I.E.E. 1933	1s.
No. 151	"RECENT REPEATER STATION INSTALLATIONS."—Major F. E. A. MANNING, M.C., B.Sc.(Eng.), M.I.E.E., A.M.I.Mech.E. 1933	1s.
No. 152	"SOME NOTES ON EXCHANGE EQUIPMENT FACTORY COSTING AND THE ECONOMICS OF PRODUCTION."—S. J. HUSBAND, Assoc.I.E.E. 1933	1s. 3d.
No. 153	"MODERN DEVELOPMENTS IN TELEPHONE TRANSMISSION OVER LINES."—J. STRATTON, A.C.G.F.C., and W. G. LUXTON. 1933	1s. 3d.
No. 154	"THE TELEGRAPH POLE."—W. H. BRENT, B.Sc., A.M.I.E.E. 1933	1s.
No. 156	"MODERN TENDENCIES IN THE SUPPLY OF POWER TO TELEPHONE EXCHANGES."—H. C. JONES, B.Sc.(Eng.). 1935	9d.
No. 158	"ULTRA SHORT WAVE RADIO TELEPHONE CIRCUITS."—D. A. THORN, B.Sc.(Eng.), A.M.I.E.E., and H. T. MITCHELL, A.M.I.E.E. 1935	1s.
No. 159	"MODERN ELECTRIC PASSENGER LIFTS."—R. S. PHILLIPS, A.M.I.E.E. 1935	9d.
No. 161	"MODERN TELEPHONE REPEATER STATION POWER PLANT."—F. W. G. DYE. 1936	6d.
No. 162	"VOICE FREQUENCY SIGNALLING ON TRUNK CIRCUITS."—T. H. FLOWERS, B.Sc., A.M.I.E.E., and B. M. HADFIELD, B.Sc., A.M.I.E.E. 1937	1s.
No. 163	"AUTOMATIC EXCHANGE DESIGN."—H. E. FRANCIS. 1936	1s. 3d.
No. 164	"THE LONDON-BIRMINGHAM COAXIAL CABLE SYSTEM."—A. H. MUMFORD, B.Sc.(Eng.), A.M.I.E.E. 1937	1s. 3d.
No. 165	"PROPERTIES AND TESTING OF DI-ELECTRIC MATERIALS."—J. F. DOUST and W. J. SULSTON, M.Sc., A.Inst.P. 1938	1s.
No. 166	"CHEMISTRY AND COMMUNICATIONS."—D. W. GLOVER, M.Sc., A.I.C. 1937	6d.
No. 167	"TWELVE-CIRCUIT CARRIER TELEPHONE SYSTEMS."—G. J. S. LITTLE, B.Sc., A.M.I.E.E. 1938	6d.
No. 168	"THE DEVELOPMENT OF MAGNETIC MATERIALS."—C. E. MORGAN, A.M.I.E.E. 1938.. .. .	6d.
No. 169	"CROSSTALK."—H. C. S. HAYES, A.M.I.E.E., R. A. SEYMOUR and P. R. BRAY, M.Sc.(Eng.), Grad.I.E.E. 1938	1s. 3d.
No. 170	"SUBSCRIBERS' CABLE DISTRIBUTION—RECENT DEVELOPMENTS."—L. MEEK, A.M.I.E.E. 1939	6d.
No. 171	"MULTI-CIRCUIT CARRIER TELEPHONY."—E. M. RICHARDS, A.C.G.I., B.Sc. (Eng.), M.I.E.E., and F. J. D. TAYLOR, B.Sc. (Eng.). 1938	1s. 6d.



FOR
TELEPHONE & TELEGRAPH
 ALSO
TAPES & BINDERS
 in
COPPER, BRONZE & CADMIUM-COPPER

TELEPHONE
 BLACKFRIARS
 B701 (B lines)

FREDERICK SMITH & COMPANY
(INCORPORATED IN THE LONDON ELECTRIC WIRE COMPANY AND SMITHS, LIMITED)
 ANACONDA WORKS, SALFORD, 3, LANCS.

TELEGRAMS
 ANACONDA
 MANCHESTER

★
TELEGRAPH APPARATUS
for
MORSE SYSTEMS

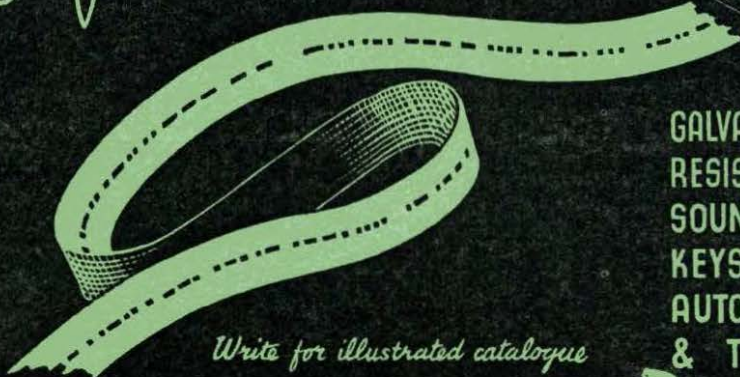

Makers of:

GALVANOSCOPES · INKERS
 RESISTANCES · RELAYS
 SOUNDERS · DETECTORS
 KEYS · MILLIAMMETERS
 AUTOMATIC RECEIVERS
 & TRANSMITTERS ETC

Write for illustrated catalogue

ELLIOTT BROTHERS (LONDON) LTD. CENTURY WORKS,
 LEWISHAM, S.E.13

MAINTAINING EFFICIENCY



THE HIGH STANDARD OF EFFICIENCY OF
PIRELLI GENERAL TELEPHONE CABLES IS
MAINTAINED BY THE CONTINUOUS
RESEARCH WORK OF AN EXPERIENCED
TECHNICAL STAFF.

TELEPHONE
SOUTHAMPTON
2141 (5 LINES)

PIRELLI-GENERAL
CABLE WORKS, Ltd., SOUTHAMPTON.

TELEGRAMS
"PIGEKAYBEL,
SOUTHAMPTON."